



EUROPEAN SOUTHERN OBSERVATORY

Organisation Européenne pour des Recherches Astronomiques dans l'Hémisphère Austral
Europäische Organisation für astronomische Forschung in der südlichen Hemisphäre

LA SILLA PARANAL OBSERVATORY

┌

INTERFACE
SPECIFICATION FOR
VISITING INSTRUMENTS
IN LA SILLA
OBSERVATORY

└

Report

LSO-SPE-ESO-00000-0003

Issue: 2.0

Date: August 15th, 2012

└

Prepared: G.Ihle

15.08.12

Name

Date

Signature

Approved : M Sterzik/U.Weilenmann

Name

Date

Signature

Released : A.Kaufer

Name

Date

Signature

Change Record

Issue/Rev.	Date	Section/Page affected	Reason/Initiation/Document/Remarks
1.0	1.10.07	All	
1.1	1.11.07	Network and communications	Comments received from IT
1.2	18.04.08	Figures, Tables and new information	Comments Received
1.3	10.05.08	Page 5, Section 3.1.1	Correction in NTT focus limits
1.4	29.05.08	Page 8, Section 3.1.2	Power stability and grounding connections
1.5	15.03.09	Network and communications	New approved policy
2.0	15.08.12	All	New Operating Building (NOB)

Contents

1	INTRODUCTION.....	5
2	GENERAL SCOPE.....	5
2.1	PURPOSE OF DOCUMENT	5
2.2	HOSTING TELESCOPES AND FOCI.....	5
2.3	NEW OPERATIONS BUILDING (NOB)	5
3	NTT TELESCOPE	6
3.1	PROPOSED FOCUS.....	6
3.1.1	<i>Mechanical and hydraulic interfaces</i>	6
3.1.2	<i>Electrical interface</i>	9
3.1.3	<i>Network interface</i>	10
3.1.4	<i>Optical interface</i>	10
3.1.5	<i>Observation Facilities</i>	12
3.1.6	<i>Integration facilities</i>	14
3.1.7	<i>Cryogenics</i>	19
3.1.8	<i>Safety requirements</i>	19
4	3.6M TELESCOPE	19
4.1	PROPOSED FOCUS.....	19
4.1.1	<i>Mechanical and Hydraulic Interfaces</i>	21
4.1.2	<i>Electrical Interface</i>	24
4.1.3	<i>Network Interface</i>	25
4.1.4	<i>Optical Interface</i>	26
4.1.5	<i>Observation Facilities</i>	27
4.1.6	<i>Integration Facilities</i>	28
4.1.7	<i>Cryogenics</i>	29
4.1.8	<i>Safety Requirements</i>	29
5	2.2M TELESCOPE	29
5.1	PROPOSED FOCUS.....	30
5.1.1	<i>Mechanical and Hydraulic Interfaces</i>	31
5.1.2	<i>Electrical Interface</i>	33
5.1.3	<i>Network Interface</i>	33
5.1.4	<i>Optical Interface</i>	34
5.1.5	<i>Observation Facilities</i>	35
5.1.6	<i>Integration Facilities</i>	36
5.1.7	<i>Cryogenics</i>	36
5.1.8	<i>Safety Requirements</i>	37
6	ANNEXES.....	37
6.1	MAP OF LA SILLA	37

1 Introduction

La Silla Observatory is hosting regularly Visitor Instruments and is the purpose of this document to specify which focus and telescopes can host a Visitor instrument. A Visitor Instrument is attached to a telescope, for the duration of a run of observation and then removed from the telescope. Therefore the requirements to be fulfilled by the visitor instrument differ from the ones specified by the ESO instruments and may not fulfill all the requirements requested to the usual ESO Instrumentation.. For each of them, it defines the different interfaces (optical, mechanical, electrical, cooling supply, remote control) to the telescope and it specifies the requirements that the Visitor Instrument has to meet to be operated properly in each telescope focus.

2 General scope

2.1 Purpose of Document

This document describes the minimum requirements for a visitor instrument to be successfully mounted in the hereafter proposed telescopes and their available foci. It is intended to give all the necessary information to prepare the installation of a Visiting Instrument on the offered ESO telescopes for this purpose.

2.2 Hosting telescopes and Foci

A Visiting Instrument could be installed in the following foci:

- NTT telescope in both two Nasmyth foci (side A or side B)
- 3.6m telescope in the Cassegrain focus
- 2.2m Telescope in the Cassegrain focus

2.3 New Operations Building (NOB)

Since October 2010 the three ESO operated telescopes are controlled from the New Operations Building (NOB) located in the old Administration Building and in place of the Observatory Library¹.

All terminals controlling telescopes, domes and instrumentation have their station in three independent sectors of the room.

¹ Not existing anymore

The Visiting Instrument can also be controlled from this place in the event that the control can be done through the VLAN dedicated for the purpose. However, the telescope control can only be done from the NOB terminals.



Figure 1: New Operation Building (NOB)

3 NTT Telescope

The telescope is a strict Ritchey/Chrétien. The limiting factors are astigmatism and field curvature.

The telescope coordinates (degrees and fraction of it, WGS 84) measured with GPS and a precision of +/-2 mts: **S29.25896 W70.73374**

3.1 Proposed Focus

3.1.1 Mechanical and hydraulic interfaces

The instrument is fixed to the adapter-rotator flange shown in the following drawing. The fixation is done by means of 48xM10 bolts located in a diameter of Ø1580 mm.

The nominal optical focus is located at **500mm** from the rotator adapter instrument fixation face, being f11 at this position. The secondary mirror focal mechanical movement has a range of +/- **20mm** and a resolution of **5 µm**. There is a software limit of this range to +/- **15 mm** with 1mm equivalent to 1024 eu.

The rotator unit with the adapter box has the task to compensate the sky rotation. It supports the instrumentation and houses some opto-mechanical components like guiding cameras, calibration lamps, and power supplies among others. An ETEL torque motor drives it and it is monitored by a high precision HEIDENHAIN encoder. A.T.V. brake assures the stability when the unit is parked.

The complete structure has been analyzed by finite element under the maximum possible load condition that is **2000 kg** at **270 mm** from the fixation flange of the instrument. This calculation gave a lateral displacement at the focus plane of the telescope (500 mm from the fixation flange) of 6 microns. The maximum allowable deflection of the hub is 3 arcsec with a load of 800 N at 400 mm from fixation flange.

The rotator-adapter allows a maximum unbalance of **200 N-m**. An increase of this unbalance results in tracking problems.

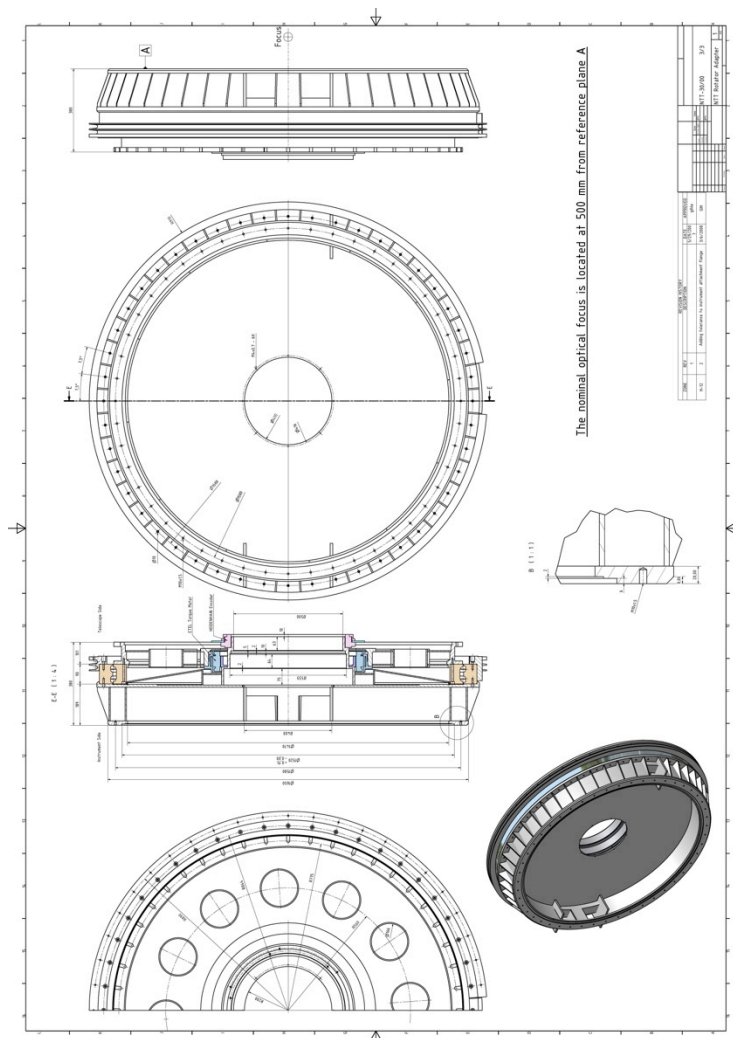

Figure 2: NTT Adapter Rotator

3.1.1.1 Compressed Air

There is no compressed air supply in the telescope.

3.1.1.2 Cooling Liquid

The telescope has manifold located close to the wall on the floor of each focus room (A and B), providing cooling liquid (Water + 30% Glycol) at a temperature of 2 to 3°C and 3.6 bar of maximum supply pressure and return pressure of 1 bar. Flow is estimated in 3 lts/min.

3.1.2 Electrical interface

In each instrument foci there is power in the rotator adapter (rotational part) and in wall plugs within the instrument room.

Power supply stability:

- Normal net: 220VAC +/-6%
 50 Hz +/- 1 Hz

- UPS net: 220VAC +/-1%
 50 Hz +/- 0.1Hz

3.1.2.1 Rotational Parts (Rotator Adapter)

The telescope's Nasmyth foci have 220 VAC Stabilized Power.

Power available on rotary part (instrument flange), 220 VAC, 10 A, 50Hz, UPS.

Connector needed:

Make: HIRSCHMANN
Model: STAK20

The adapters are properly grounded and the entire telescope mass and the building are galvanic connected through the sleep ring to the service ground outside telescope.

In rotator side B available connector type: SCHUKO (CEE7) plug

3.1.2.2 Instrument Room Walls

At instrument rooms floors there are both 3 phase and single phase power, normal and UPS on wall outlets.

The cable length from these outlets to the instrument is approximately 9mts considering the slack required for the rotator adapter rotation.

Stabilized Power available on wall outlets:

220 VAC, 10A, 50Hz single phase, on three outlets.
Necessary connector type: SCHUKO (CEE7) plug.

Normal Power available on wall outlets:

220 VAC, 10A 50Hz single phase, on three outlets.
Necessary connector type: SCHUKO (CEE7) plug.

380 VAC, 3phase, 10A per phase, 50Hz, on one outlet:

Necessary connector type: IEC60309 (CEE17), 3P+N+E, 16A.

Only at focus A (SOFI room), 380 VAC, 3phase, 6A, 50Hz, on one outlet:

Necessary connector type: IEC60309 (CEE17), 3P+N+E, 16A.

3.1.3 Network interface

A dedicated LAN, with its own IP range (Class C Subnet) is available to Guest instruments situated at any active ESO telescope. Address allocation will be defined by ESO. This LAN is by default isolated, meaning no routing to other telescope LANs (TCS etc), or to the Internet. The LAN can be patched to connect the instrument with the control room (NOB) allowing the remote operation from this site.

Routing to additional internal LANs (to allow access to TCS as an example) can be configured if the required approval is obtained. Inbound and Outbound connections (outside of the La Silla Control LANs) are not permitted.

There are 2 Ethernet connectors on the wall (~15 meters cable needed for reaching the visitor instrument) at the instrument rooms. This is the telescope network, type offering RJ-45 connection at 10/100 BaseT, half/full duplex.

There is a possibility for the user to install cables from the instrument to the old local control room at the second floor where to install more computers or equipment. (From instrument to old local control room **40 mts**).

There is the possibility for a peer-to-peer connection via monomode fiber between the fiber patch panels at NTT to fiber patch panel in NOB. This connection will need a media converter or a monomode fiber link at both ends to communicate the instrument with a computer in the NOB.

3.1.4 Optical interface

The telescope optics design is a Richey-Chretien with a Schott Zerodur main mirror. Its diameter is 3580 mm, thin meniscus (24 cm). The active support consists of 75 axial actuators, 3 fixed points and 24 lateral actuators. The focal ratio is f/2.2.

The secondary mirror made of Schott Zerodur has Ø875 mm and a central obstruction of Ø1160mm.

The tertiary mirror also made of Schott Zerodur has major and minor axis of 840mm and 600mm respectively.

The Nasmyth foci field view is **30 arc min, 336.6mm and focal ratio of f/11**. The plate scale is **5.35905 arcsec/mm**. The Image Quality: **80% energy in 0.15"** in all telescope positions.

The Secondary mirror (M2) focus range is +/- **20 mm** and a resolution of **1 µm**. The displacement speed is **0.42 mm/sec**.

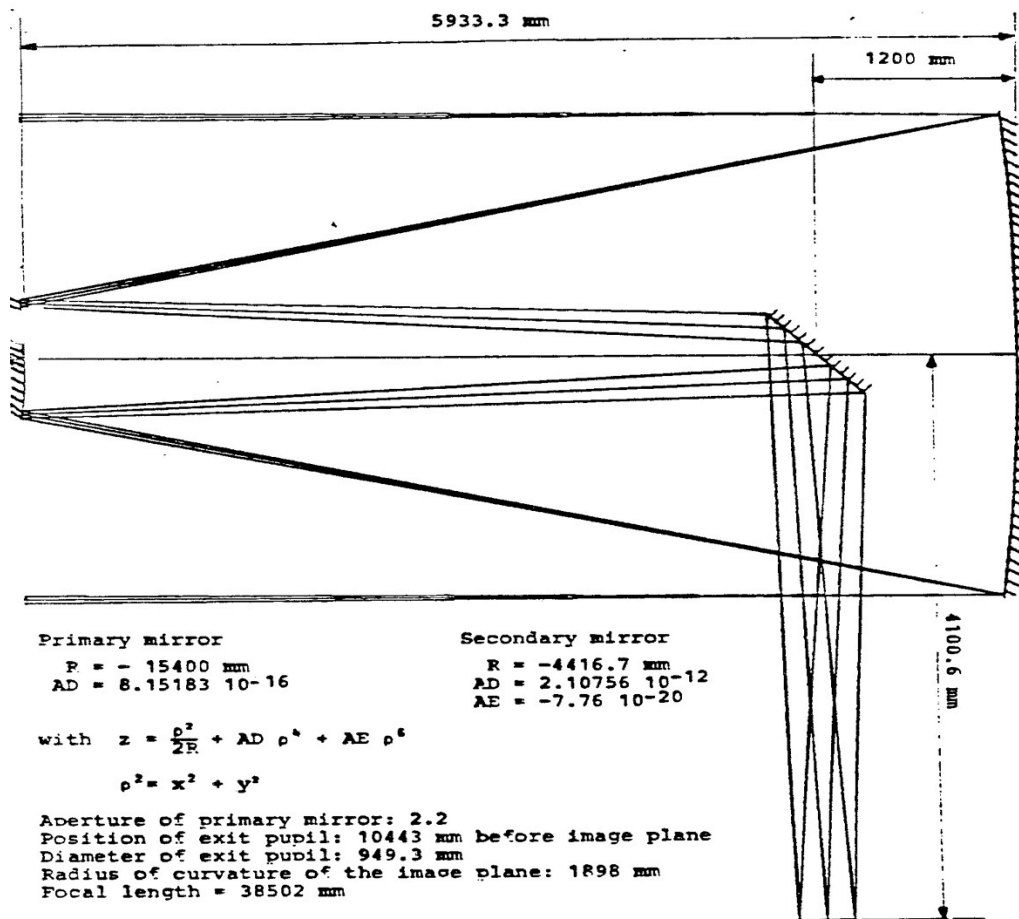

Figure 1

Figure 4: NTT Optical Path

The de-centering coma correction is achieved by turning the secondary mirror about its center of curvature (x-y movement in the plane of the mirror). This method has the advantage of introducing no pointing error. To compensate 1 arc sec of coma, a tilt of 1.224 min is needed; this value corresponds to a displacement of 1.57 mm in the plane of the mirror.

The sensitivity of the telescope to de-centering is around 1 arc sec of coma for a 1 mm transversal displacement of the secondary mirror.

The average pointing accuracy is **1.0 arcsec rms** with pointing model over most of the sky. Degradation occurs close to the zenith and at zenith angle larger than 60 degrees.

The range of variation of the pointing model goes from **0.5 to 1.5 arc sec rms**

The average tracking speed is **0.3 deg/min** having a maximum of **1.5 deg/sec** approaching a dead angle of **0.15 to 0.2 degrees** from Zenith and accelerations of about **0.03 deg/sec²**. However, a software limitation to 3 deg from Zenith is implemented.

3.1.5 Observation Facilities

A Visiting Instrument can be controlled from NOB via the available network (VLAN) or, in the event of special cabling; the instrument and telescope can be controlled from the old control room situated in the telescope building.

NTT Local Control Room has enough space to place computers and people; as shown in the following picture.



Figure 5: NTT Local Control Room (2nd Floor)

There is a GPS providing Time and PPS signals with precision for astronomy.

In the event that the user brings a GPS, there is currently an antenna pole installed at the NTT roof with the required cable routing as shown in the pictures below.



Figure 6: GPS Antenna Pole



Figure 7: GPS Cabling

3.1.5.1 Instrument Flanges

The Visiting instrument should provide an interface instrument flange to be attached to the adapter-rotator. However, in La Silla there are currently two flanges or adapters that can be used for the purpose.

These flange-adapters are shown in the following drawings:

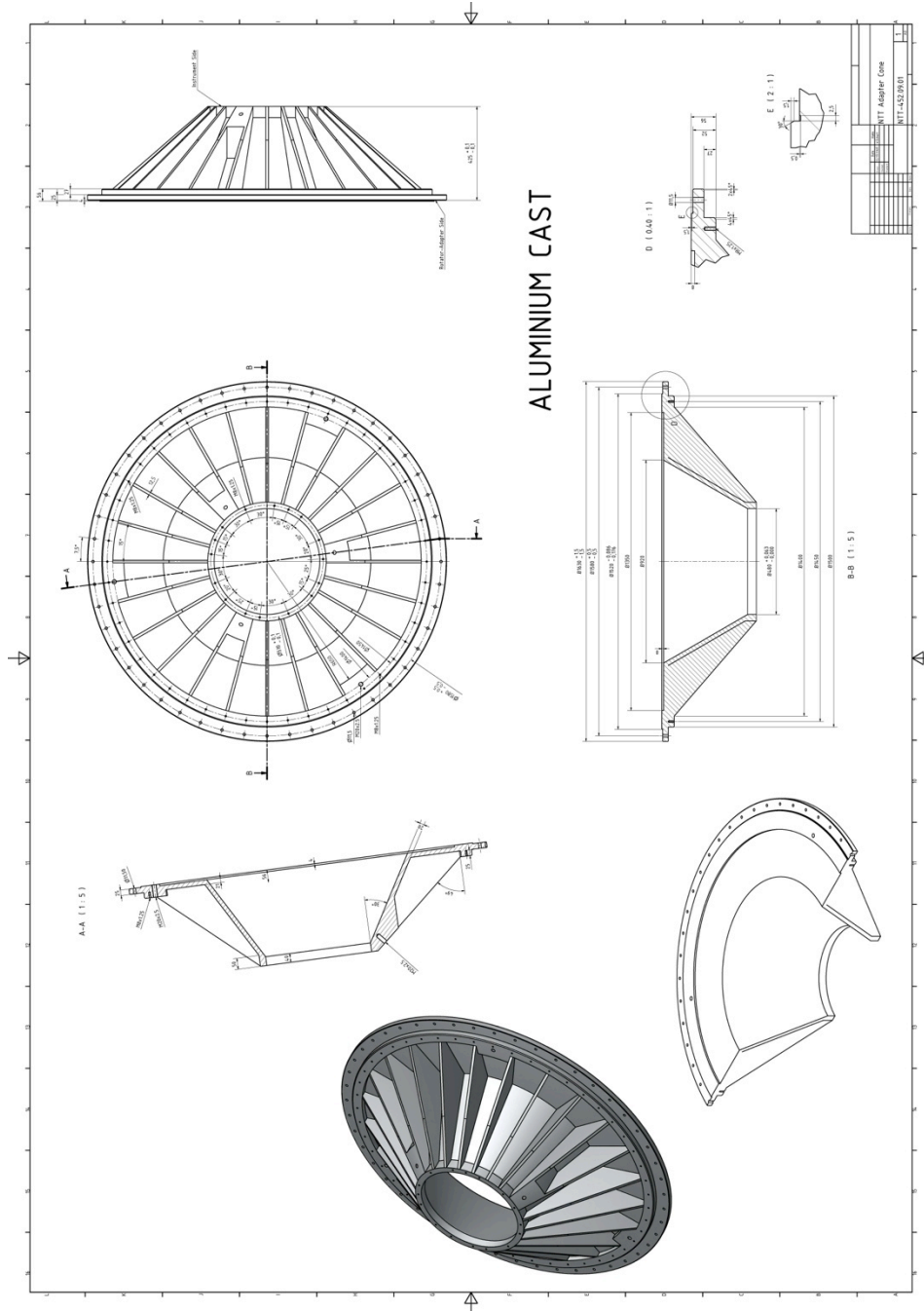

Figure 8: NTT Instrument Adapter Flange (Cone)

At NTT side A it is currently installed SOFI (Infrared Spectrograph and Imager also called Son of ISAAC) and SUSI2 (Superb Seeing Imager) infrared instruments. The area is shown in the next picture.

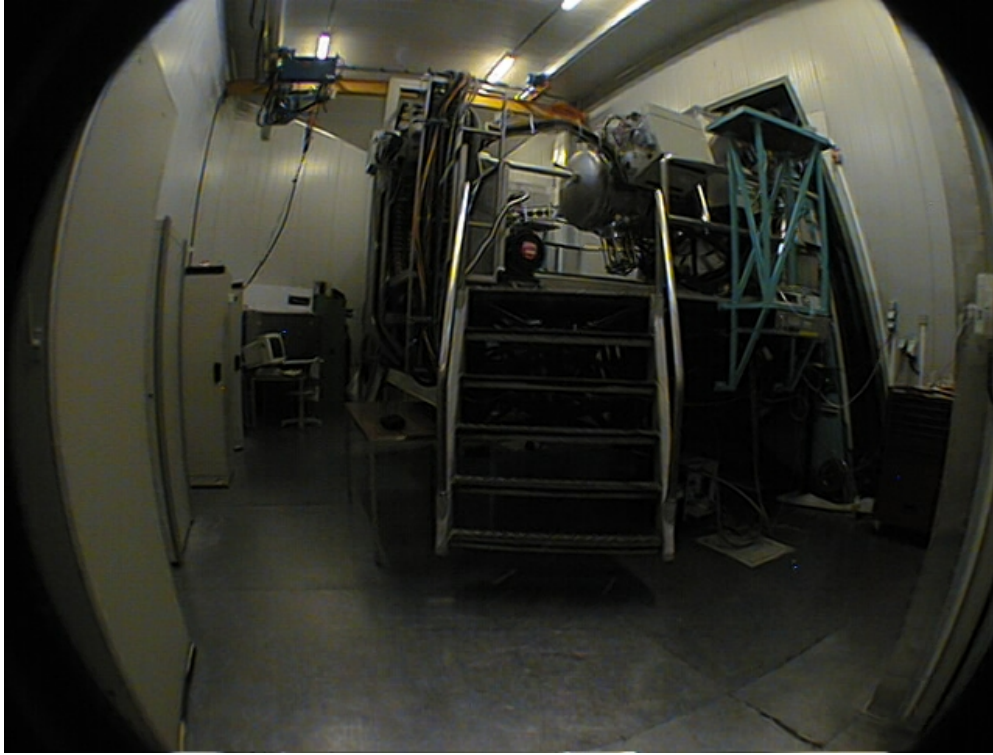

Figure 10: NTT Side A current instruments - SOFI and SUSI2

The actual available space is given by the displacement of SOFI by **750 mm**, maximum possible within the fixed platform.



Figure 11: NTT Side A available space without removing SOFI and SUSI2

- **Side B of NTT**

At NTT side B EFOSC2 (ESO Faint Object Spectrograph and Camera) is actually installed. The actual space is shown in the following picture.

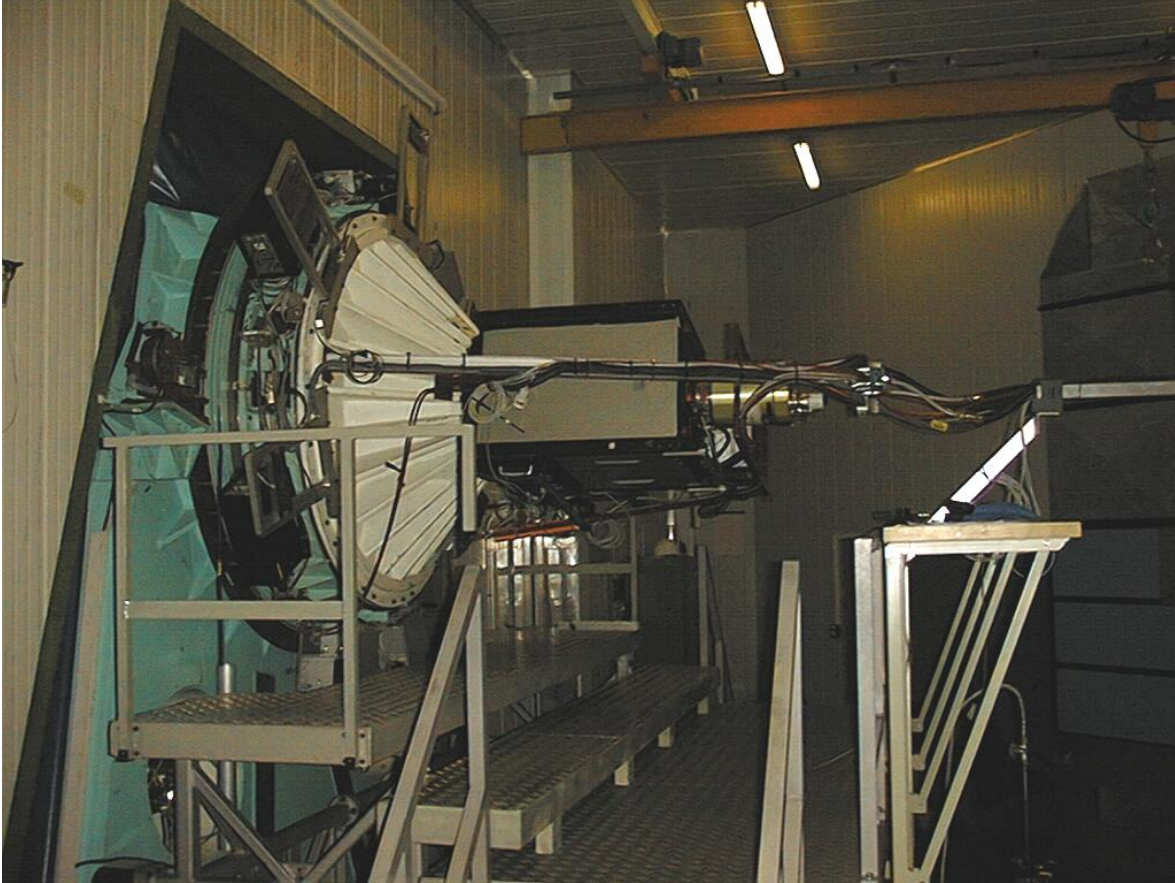

Figure 12: NTT Side B actual instrument - EFOOSC2

If the area is required for a Visiting Instrument, EFOOSC2 and the conical adapter can be removed and stored in their supporting and handling frames.

The EFOOSC2 instrument and adapter cone can be removed from the rotator flange leaving a free space of **4000 mm**.



Figure 13: NTT Side B available space in the room

Next picture shows the installation of LuckyCam in side B (EMMI against the wall covered with plastic. EMMI is actually decommissioned and stored in a different place):

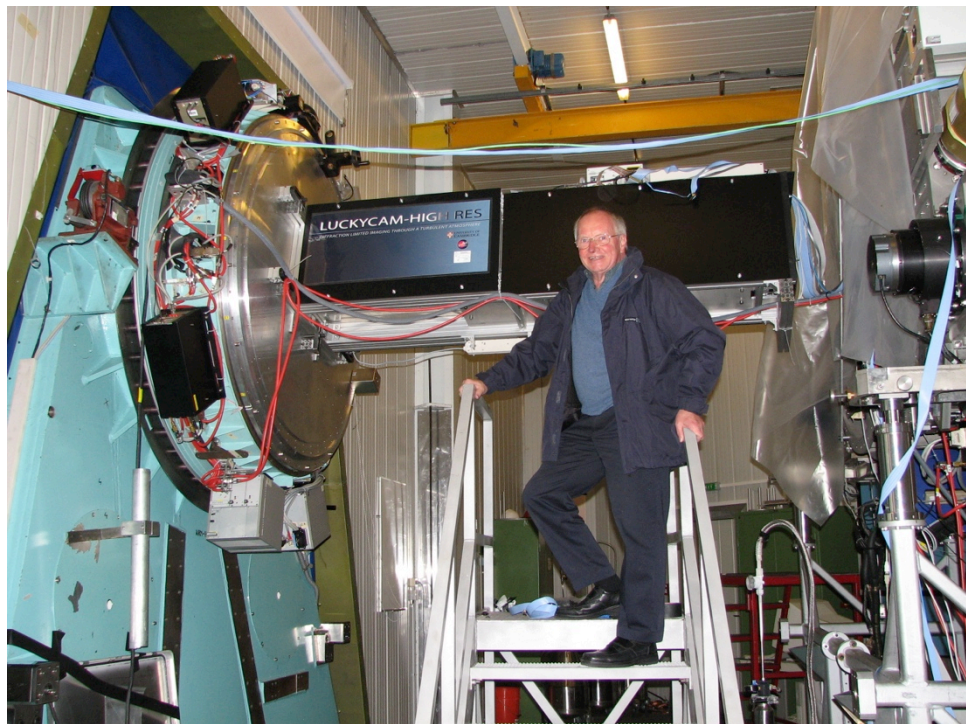

Figure 14: Visiting Instrument LuckyCam installed at side B

The access to side A is via a stairs coming from base level and to side B via the old control room. Both sides are possible to be reached via the telescope area where the instrument can be transported to this level with a van or truck.

The floor capacity is limited to **10 kN/m²**. Two rails are the reinforced area where the EFOSC2 maintenance platform-carriage is moved away from the telescope. These rails are designed and used only by this platform-carriage.

ESO can provide lifting equipment as flat loaders or manual hydraulic fork lifts, in addition there are standard lifting equipments (slings, shackles, etc.)

3.1.7 Cryogenics

The supply of Liquid Nitrogen (LN₂) is done in ESO dewars of 50 lts. These dewars are delivered on the observing floor. The observer should communicate the needs and the time when required.

The filling of the instrument is done via a standard transfer line with pressurized LN₂ at 0.5bar.

3.1.8 Safety requirements

Special care has to be considered when getting into the NTT building. The entrance is limited and the access with a card has to be authorized. Safety precautions have to be considered as the rotating building could hurt a visitant.

The Visiting Instrument owner has to provide a list of potentially dangerous things such as: type of chemicals used, devices under pressure, mechanical systems to be handled with care, requirement of cryogenics liquids for the instrument, etc.

4 3.6m Telescope

The telescope coordinates (degrees and fraction of it, WGS 84) measured with GPS and a precision of +/-2 mts: **S29.26097 W70.73169**

4.1 Proposed Focus

The Cassegrain is the only available focus at the telescope. The focus is located at the main mirror cell Cassegrain cage.

The distance from instrument attachment to optical focus is **170mm** with a range given by the secondary mirror movement of +/-**18mm** and a resolution of **1 μm**, focus being positive when moving M2 towards M1.

The relation between telescope focus (M2 focus) and the Guide Probe focus can be described in the following example. Comparing the focus of the telescope with respect to the HARPS around a nominal position, M2 value is 10.9mm (value depending on temperature). The equivalent Guide Probe focus position is 16837 units. Moving GP focus to an edge of this range (25848 units), M2 must be moved to 9.5mm to get a good focus on the GP and moving the GP focus to the other edge (289 units), M2 must be moved to 13.74mm

Therefore the Cassegrain focal plane can move from -9.8 mm to 19.7 referred to the nominal focus, range in order to be able to get a right focus in the GP. For other guiding method, the full range of M2 can be used.

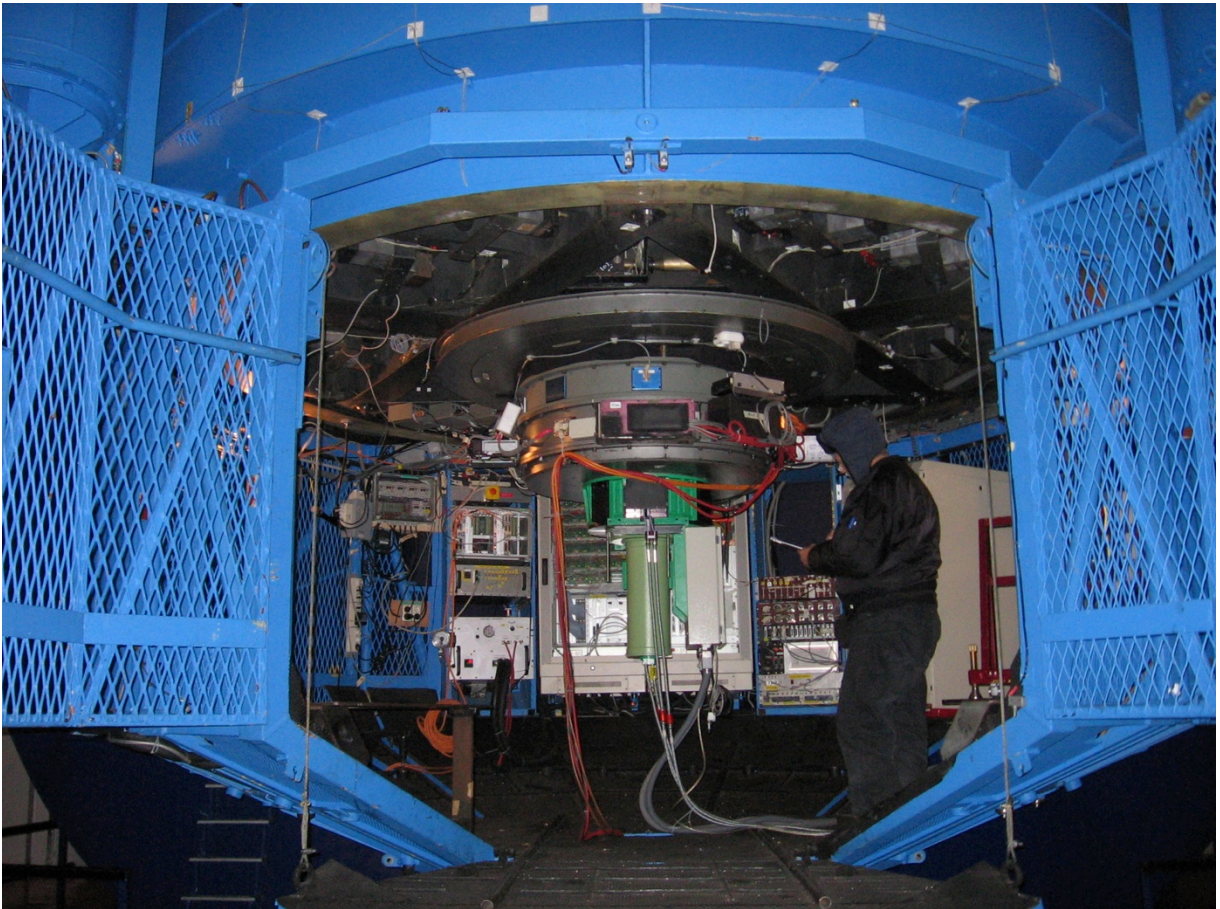

Figure 15: 3.6m Cassegrain Cage with HARPS instrument adapter installed

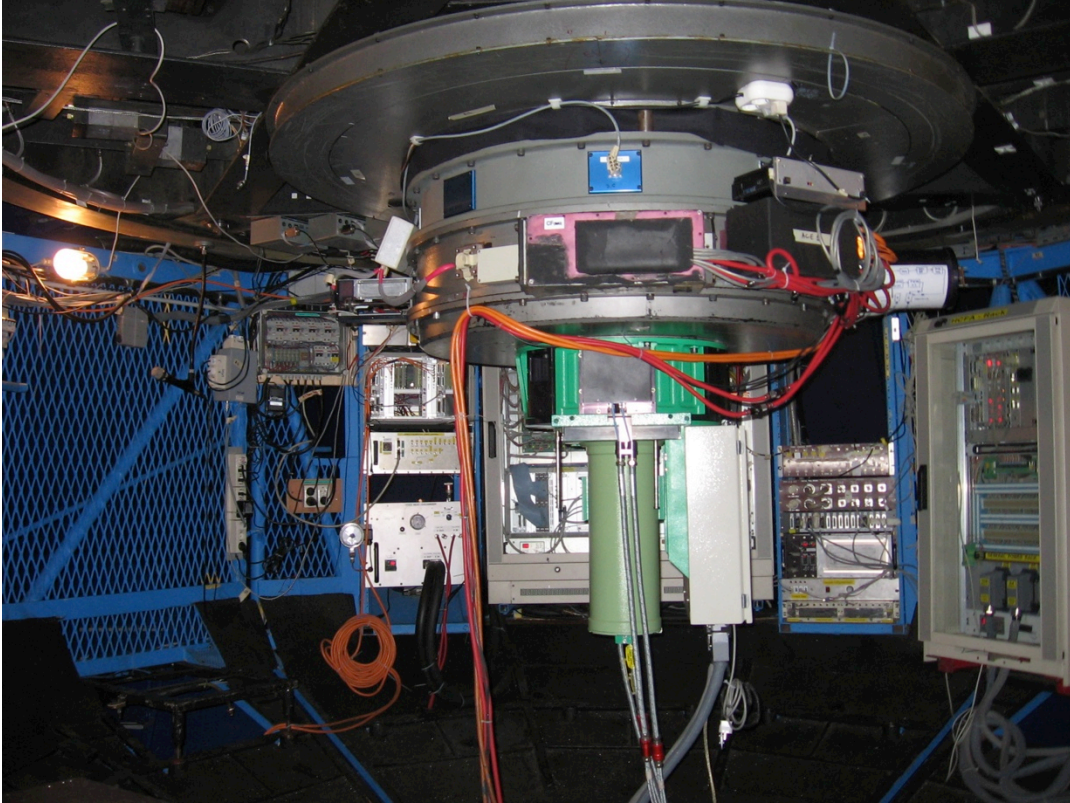

Figure 16: HARPS adapter and Instrument Rotator Adapter

4.1.1 Mechanical and Hydraulic Interfaces

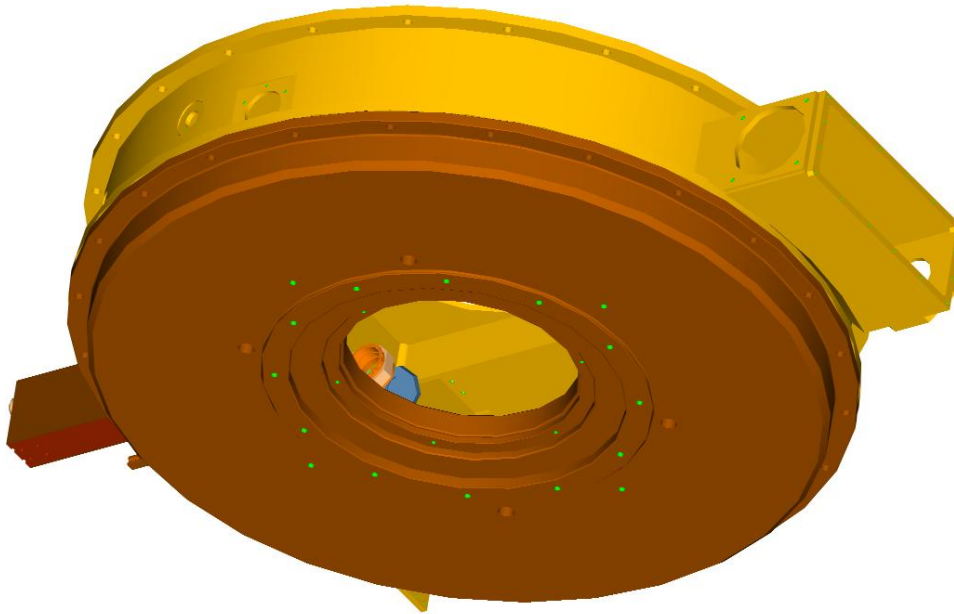

Figure 17: 3.6m Adapter 3-D drawing



Figure 18: 3.6m Rotator Adapter and HARPS adapter

The available space from instrument flange to floor of the Cassegrain cage is **1500 mm** and the free space around the telescope instrument axis is within a radius of **1200 mm**. Any instrument should consider some free space of at least **100 mm** from the above mentioned dimensions in order to allow the pass of cabling.

The instrument attachment dimensions are shown in the following figure 19:

CASS INTERFACE OF 3.6M TELESCOPE INSTRUMENT FLANGE

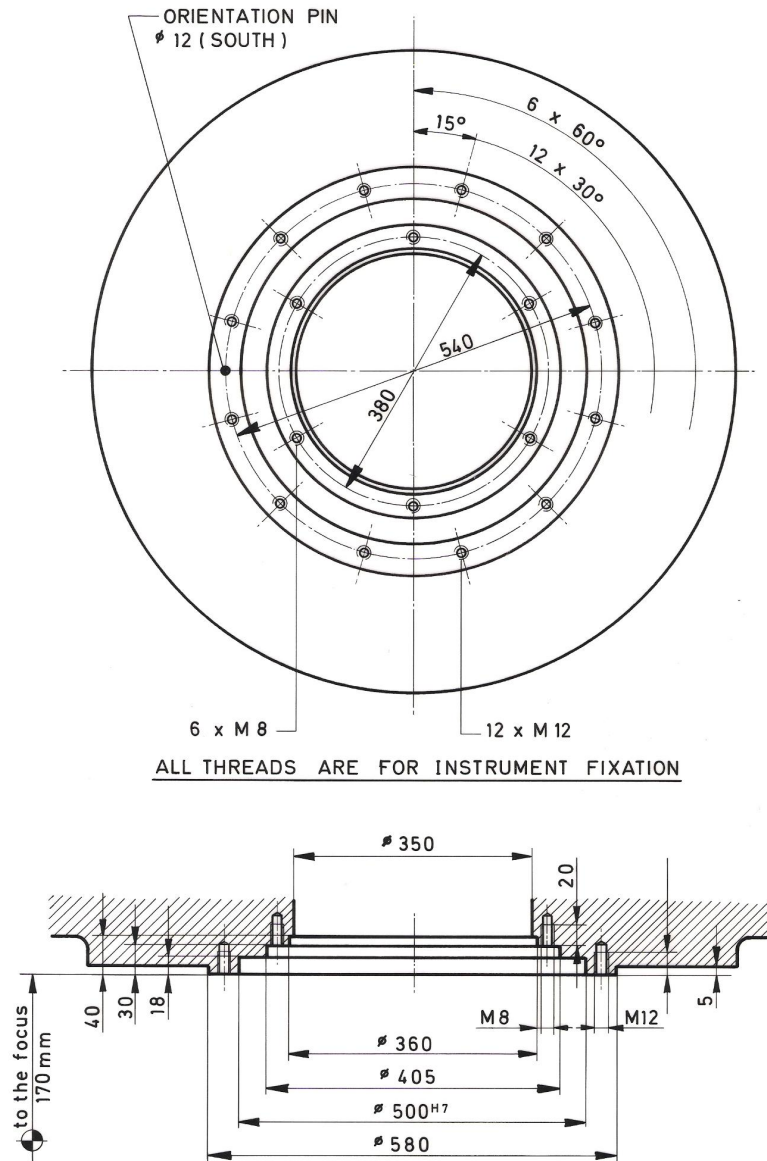

Figure 19: 3.6m Instrument Interface

Maximum load possible to apply at its focus is **7500 N** (This figure has not been checked due to unclear information)

4.1.1.1 Compressed Air

The telescope at the Cassegrain cage has dry-filtered compressed air dedicated to supply the main mirror radial supports. This air arrives 5.5 bar and it is regulated to 3 bars before entering the radial supporting system.

There is no other air supply at the Cassegrain cage.

4.1.1.2 Cooling Liquid

At the Cassegrain cage the cooling liquid (Water and 30%Glykol) is at 1 to 3.5°C, 1.7 bar input and 1 bar outlet pressure to the cage with a flow of 10 to 15 lts/min. This cooling liquid is used for the conditioning of the electronic racks therein installed, existing the possibility to connect other equipment.

At dome observing floor, in the storage laboratory room, there is a cooling liquid supply (water + 30% Glykol) at a temperature of 4°C, 2.2 bar inlet and 1 bar outlet pressure and a flow of 10 lts/min.

4.1.2 Electrical Interface

The Cassegrain cage and the control rooms are provided with normal and uninterrupted stabilized power (UPS).

4.1.2.1 Cassegrain Cage Power

Normal Power:

3 phase, 380VAC, 50Hz, 10A, 30mA Diff. protection on 2 outlets.

Necessary plug type is IEC60309 (CEE17), 3P+N+E and 16A.

220VAC 50 Hz, 10A, 30 mA Diff. protection, 4 outlets.

Necessary connector type: SCHUKO (CEE7) plug.

Stabilized Power (UPS):

Three phase, 380VAC, 50Hz, 6A, 30mA Diff. protection.

Necessary plug type: IEC60309 (CEE17), 3P+N+E, 16A.

220VAC 50 Hz, 10A, 30 mA Diff. protection, 4 outlets.

Necessary plug type: SCHUKO (CEE7).

4.1.2.2 Local Control Room

This telescope has an empty space at Observing floor that can be used by the user as a Control Room. The user could tend cables between his instrument in the Cassegrain cage and Local Control Room.

The cable length between the Cassegrain cage and Local Control Room, via hanging cables, to this empty space is 45 mts.

4.1.2.3 Old Local Control Room

The Old Local Control Room is in the third floor of the telescope building. The distance between the Cassegrain cage via hanging cables to this Local Control Room is 60 mts.

Stabilized Power available on wall outlets:

220 VAC, 10A, 50Hz single phase, on four outlets.
Necessary connector type: SCHUKO (CEE7) plug.

Normal Power available on wall outlets:
220 VAC, 10A 50Hz single phase, on four outlets.
Necessary connector type: SCHUKO (CEE7) plug.

380 VAC, 10A, 50Hz, 3phase, on one outlet.
Necessary connector type: IEC60309 (CEE17), 3P+N+E, 16A.

4.1.3 Network Interface

A dedicated LAN, with its own IP range (Class C Subnet) is available to Guest instruments situated at any active ESO telescope. Address allocation will be defined by ESO. This LAN is by default isolated, meaning no routing to other telescope LANs (TCS etc), or to the Internet. The LAN can be patched to connect the instrument with the control room (NOB) allowing the remote operation from this site.

Routing to additional internal LANs (to allow access to TCS as an example) can be configured if the required approval is obtained. Inbound and Outbound connections (outside of the La Silla Control LANs) are not permitted.

Four UTP Ethernet points type offering RJ-45 connection at 10/100 BaseT, half/full duplex.

Ten RS232 Cannon 25-pin male. These are converted to fiber going from Cassegrain cage to the third floor Old Local Control Room, then reconverted to wire. Necessary connector: D25 female on edges, Cassegrain cage and third floor, next to the Old Local Control Room. Length necessary to get the 3rd floor control room center point starting from the third floor RS232 connectors: 10 mts.

Five FO (not all of them are guaranteed to work), multimode cables, ST connector, starting on a panel at the Cassegrain cage and arriving to positions next to both control rooms. Necessary FO length to get the control room center position: 10 mts (both cases).

Ten 50 Ω BNC cables (not all of them are guaranteed to work) starting from a panel at the Cassegrain cage, arriving to the empty space which can be used as Local Control Room in the observing floor.

The central obscuration is equivalent to 0.33

The mirrors characteristics are:

- Type: Ritchey Chrétien quasi
- M1: F/3.04 R=21700 mm E=-1.11252 Ø3566 mm
- M2: F/4.5 R=-10735.9 mm E=-6.3402 Ø1200 mm
- M2 focus range: +/- 16 mm Encoder/focus step: 1micron/step

The telescope characteristics are:

- F/8.09 Scale: 7.131 arcsec/mm D80%EE=0.5 arcsec EFFL: 28914.6 mm
- Field: 10'
- Focal plane radius: (-)3546 mm
- Pointing accuracy: 5 arc sec rms

Adapter focus: 170 mm +/- 10 mm

4.1.5 Observation Facilities

The telescope control facility is located in what is called the NOB. Within this building it's located the telescope and instrument control.

However, in case of a special visiting instrument where data cannot be sent via network, at the telescope building there is the Old Local Control Room that could be used as instrument control area.

This place has also the possibility to control the telescope from terminals installed therein.

The existing facilities in the Local Control Room at the observing floor makes not recommendable to use it as Visiting Instrument control room.



Figure 21: Old Local Control Room at 3.6m telescope's 3rd Floor



Figure 22: Local Control Room at the 3.6m Observing Floor level

4.1.6 Integration Facilities

The telescope dome has two cranes with a capacity of **5 and 32 tons**. These cranes have the overhead range within a radius of **6.2 mts** for the **32 tons** and **4.3 mts** for the **5 tons**.

There is also a heavy loads lift with a capacity of 2.5 tons and dimensions of 1.6 mts by 2.4 mts and a height of 2 mts.

4.1.6.1 Main 32 tons Crane

Crane characteristics:

Capacity: 32 tons

Lifting velocity: 10/1m/min

4.1.6.2 Auxiliary 5 tons Crane

Crane characteristics:

Capacity: 5 tons

Lifting velocity: 16/1,6m/min.

At the observation level there is an electrical fork lift with a max capacity of **20kN**.

4.1.7 Cryogenics

The supply of Liquid Nitrogen (LN2) is done in ESO containers (dewars) of 50 lts. (There is one 300 lts container currently not in use, but in good conditions). These 50 lts containers (actually 2 in use) are delivered on the observing floor.

The observer should communicate the needs and the time when required.

The filling of the instrument is done via a standard transfer line with pressurized LN2 at 0.5 bar.

4.1.8 Safety Requirements

The 3.6m telescope is big structure that requires special safety measurements while visiting or working within the building premises.

The entrance to the building is limited by a card access authorization. Special care has to be taken with the lift capacity and dimensions that takes the people to different levels.

The Visiting Instrument owner has to provide a list of potentially dangerous things such as: type of chemicals used, devices under pressure, mechanical systems to be handled with care and by specially trained manpower, requirement of cryogenics liquids for the instrument, etc.

5 2.2m Telescope

The telescope coordinates (degrees and fraction of it, WGS 84) measured with GPS and a precision of +/-2 mts: **S29.25785 W70.73665**

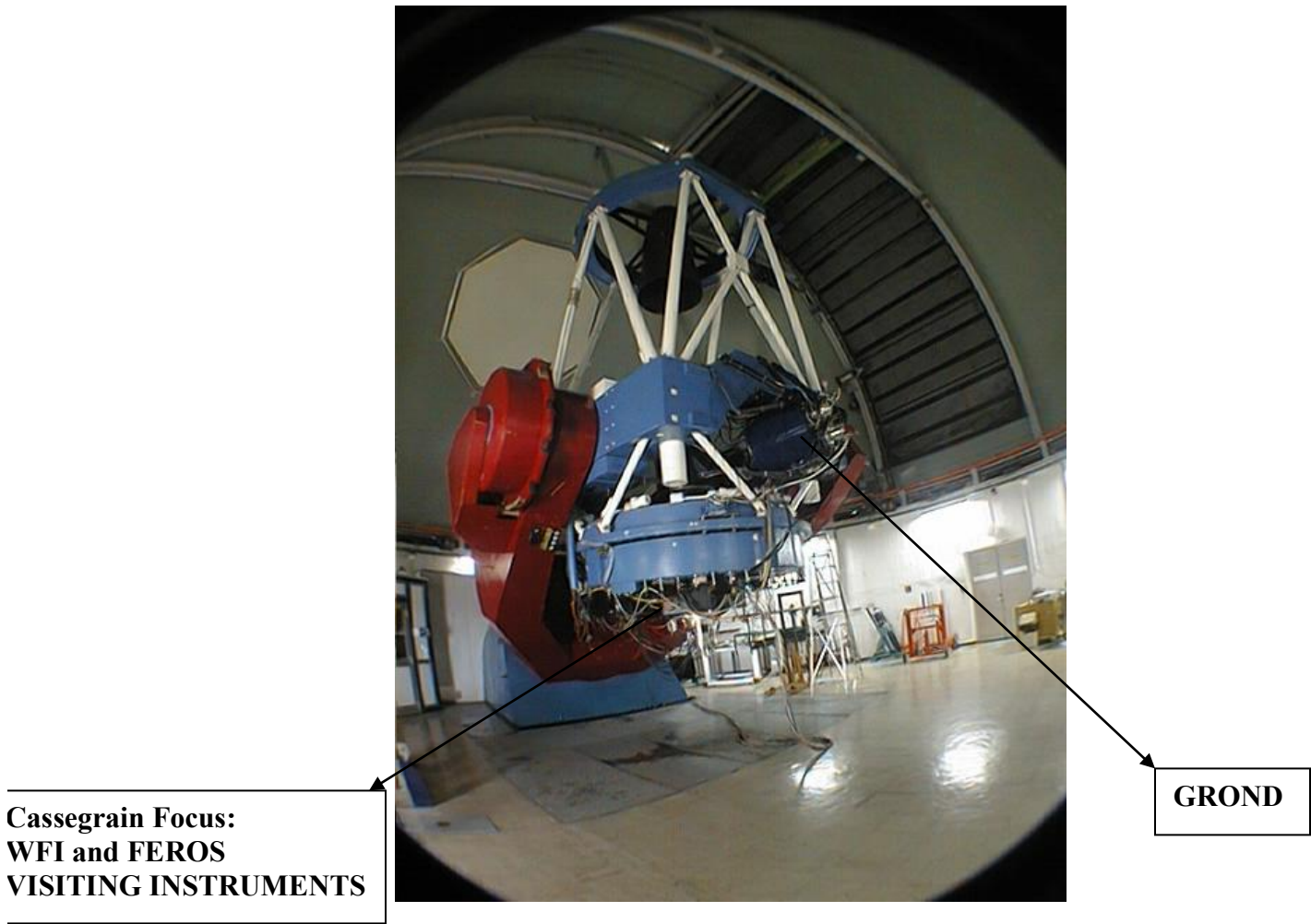

Figure 23: 2.2m Telescope with current instrumentation

5.1 Proposed Focus

The 2.2m telescope has only the Cassegrain focus available for Visiting Instrument. The optical focus is located at **400mm** from instrument attachment spacer flange. The focal range given by the secondary mirror movement is **+/-15mm** with a resolution of **1.25 μm**.

5.1.1 Mechanical and Hydraulic Interfaces

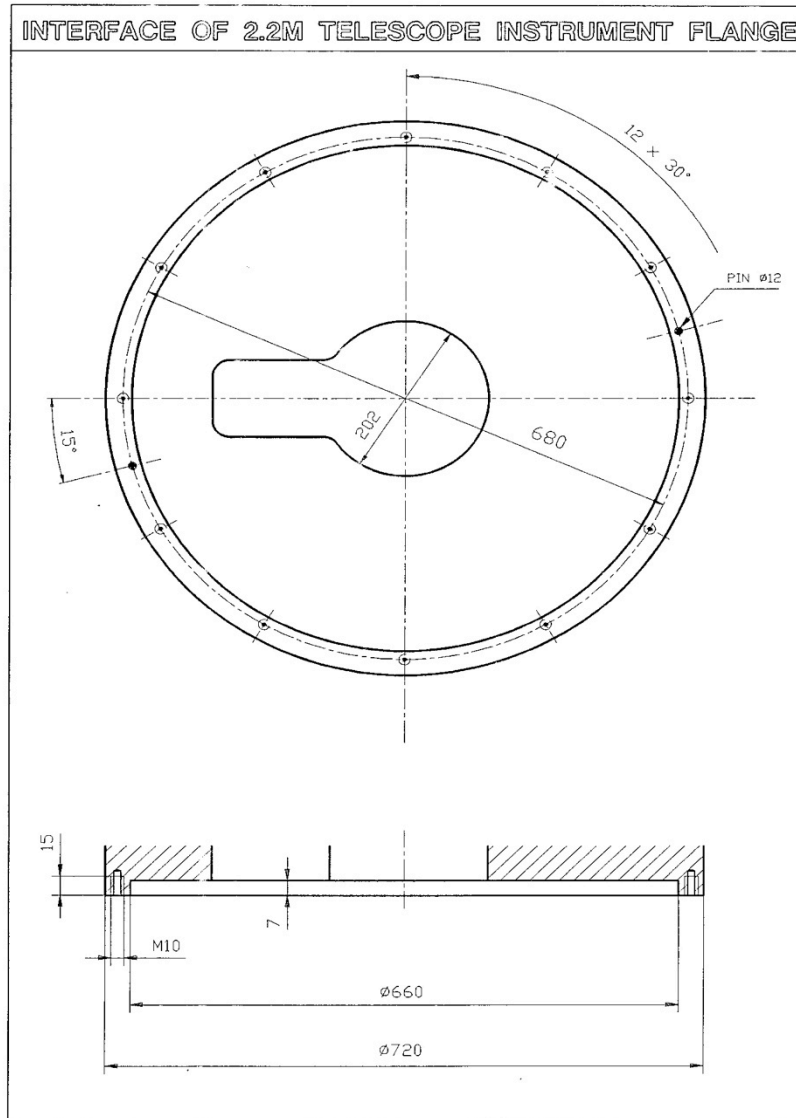
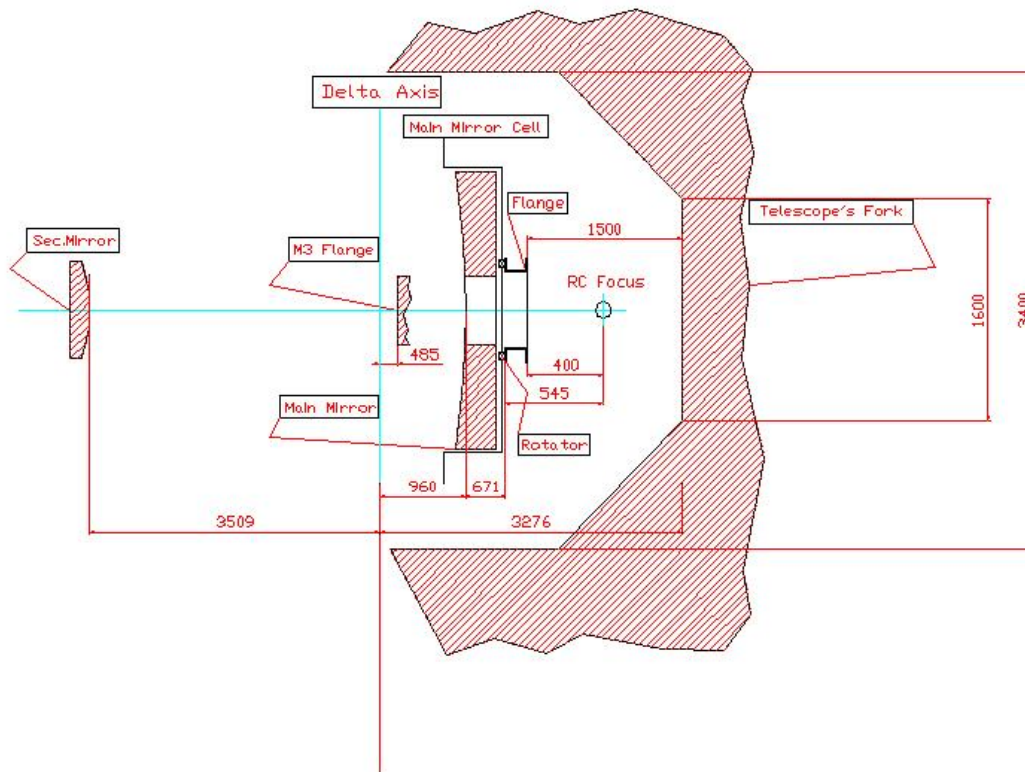

Figure 24: 2.2m Instrument Interface



Max. allowable weight at the RC Focus : 300 Kgf

Figure 25: 2.2m Main Dimensions

5.1.1.1 Compressed air

At the telescope primary mirror cell level there is a dry-filtered air supply line used primary for the main mirror axial pneumatics supports (2.1 bar inlet). An independent line is providing dry air in small amounts (only when RH greater than 50%) to avoid condensation in detectors' windows.

There is no extra compressed air available for other purposes.

5.1.1.2 Cooling liquid

There is a cooling liquid (pure water) manifold installed at the telescope centerpiece. The water is delivered at 7 to 10.5°C and inlet 2 bar and return 1 bar of pressure. This liquid is used for the TCCDs, FIERAs and GROND electronics cooling and it is delivered by an independent chiller ALFA LAVAL that provides the liquid in a close circuit with a total delivery flow of 35 lts/min. Up to 10 lts/min can be used for Visiting Instruments.

At the observing floor and assembly room there is a second resource of cooling liquid at 3°C and 2.3 bar inlet and 1 bar return pressure with a flow rate of 5 lts/min. These conditions are valid for one or the other outlet; not at the same time. This liquid (water + 30%Glykol) is coming from the building's floor cooling system and it is provided by a lines placed at the south wall of the observing floor.

5.1.2 Electrical Interface

The observing floor (including the telescope's instrument area) and the control room are provided with normal and uninterrupted stabilized power.

5.1.2.1 Instrument area Power

Stabilized Power (UPS) only:

4 socket 220VAC 50 Hz, 6A, 30 ma Diff. protections.

Necessary plug type: SCHUKO (CEE7).

5.1.2.2 Observing Floor Power on wall

The plugs are located on the wall of the observing floor. The length of cabling required to reach the instrument in the telescope is 12 to 15mts, considering the telescope movement.

Normal Power:

3 phase, 380VAC, 50Hz, 10A, on 2 outlets.

Necessary plug type is IEC60309 (CEE17), 3P+N+E and 16A.

220VAC 50 Hz, 16A single phase, 6 outlets.

Necessary connector type: SCHUKO (CEE7) plug.

Stabilized Power (UPS) is not available.

5.1.2.3 Local Control Room Power

Normal Power:

220VAC 50 Hz, 10A, 30 ma Diff. protection, 6 outlets.

Necessary connector type: SCHUKO (CEE7) plug.

Stabilized Power (UPS):

220VAC 50 Hz, 10A, 30 ma Diff. protection, 6 outlets.

Necessary plug type: SCHUKO (CEE7).

5.1.3 Network Interface

A dedicated LAN, with its own IP range (Class C Subnet) is available to Guest instruments situated at any active ESO telescope. Address allocation will be defined by ESO. This LAN is by default isolated, meaning no routing to other telescope LANs (TCS etc), or to the Internet. The LAN can be patched to connect the instrument with the control room (NOB) allowing the remote operation from this site.

Routing to additional internal LANs (to allow access to TCS as an example) can be configured if the required approval is obtained. Inbound and Outbound connections (outside of the La Silla Control LANs) are not permitted.

Two UTP Ethernet points are placed on the telescope's instrument area, and four at the local control room, type offering RJ-45 connection at 10/100 BaseT, half/full duplex.

Four FO, multimode cables, ST connector, starting on a panel at the Cassegrain near the instrument and arriving to a panel located next to the control room.

Necessary FO length to get the instrument starting from the panel on Cassegrain: 3 mts.

Necessary FO length to get the electronic racks starting from the panel on the local control room vicinity depends on where you put your racks: minimum length: 2meters max around 15 mts

5.1.4 Optical Interface

The main mirror is a M1 passive optics supported by 17 pneumatic axial supports plus 3 fix axial supports, and 24 radial mechanical lever statics supports plus a central fix ring supports.

The central obscuration is equivalent to 0.35

The mirrors characteristics are:

- Type: Ritchey Chrétien quasi
- M1: F/3 R=13200 mm E=-1.134443 Ø2200 mm
- M2: F/4.02 R=-6816 mm E=-6.537936 Ø844 mm
- M2 focus range: +/- 15 mm Encoder/focus step: 1.25micron/step

The telescope characteristics are:

- F/8.01
- Scale: 11.7 arcsec/mm D80%EE=0.35 arcsec EFL: 17612 mm
- Field: 33 arcmin or 170 mm free of vignetting
- Focal plane radius: 2228 mm
- Pointing accuracy: 5 arc sec rms

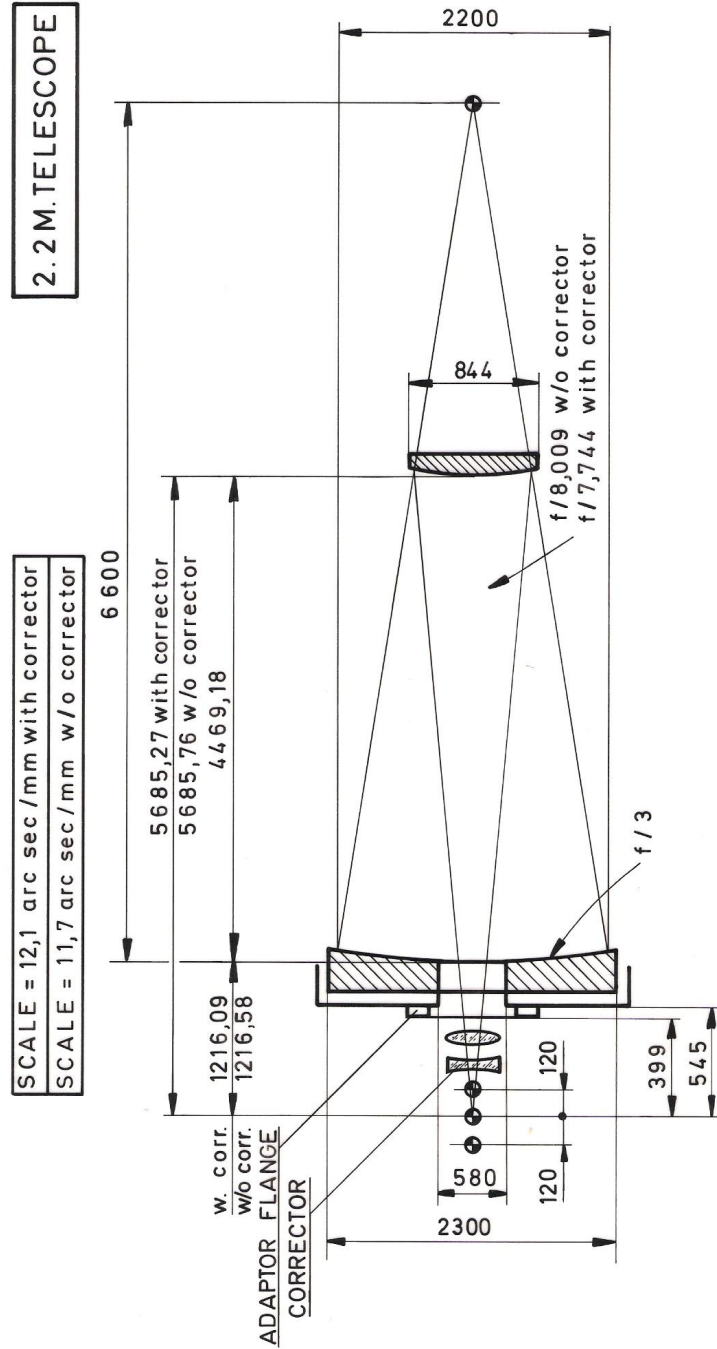

MECHANICAL FOCUS RANGE = 240 , F 315 IS FIXED, WHEN TV ATTACHMENT IS MOUNTED. CLEARANCE BETWEEN FORK AND INSTRUMENT FLANGE 1645 (1415 WITH TV ATTACHMENT) INTERFACE OF INSTRUMENT FLANGE SYSTEM : RITCHEY - CHRETIEN

Figure 26: 2.2m Optical Path

5.1.5 Observation Facilities

The standard telescope and instrument control is done from NOB control room. In case that the instrument requires special control lines and the available network is not sufficient, the Old Local Control Room can be used for controlling both the instrument and telescope.



Figure 27: 2.2m Telescope Old Local Control Room

5.1.6 Integration Facilities

The telescope dome has a direct access to the observing floor for vans or light trucks. At the observing floor there is a bridge crane with a capacity of **3 tons**.

There is a lift going from ground floor to the observing floor level with a load capacity of 2 tons and dimensions of 1.56 mts by 2 mts and 2.2 mts height.

Within the telescope building there is a room possible to be used for instrument integration. The room (5x5m²) has power 220VAC normal and UPS, as well as 380VAC. There is neither crane nor lifting device. A limiting aspect is the access to it through a narrow corridor (width 1.06mts).

This room has also water cooling liquid access en case of necessity.

5.1.7 Cryogenics

The supply of Liquid Nitrogen (LN₂) is done in containers (dewars) of 50 lts. These dewars (actually 2 in use) are delivered on the observing floor. The observer should communicate the needs and the time when required.

Actual instrumentation in use has dedicated 200 lts. dewars (4 units)

The filling of the instrument is done via a standard transfer line with pressurized LN₂ at 0.5 bar.

5.1.8 Safety Requirements

The entrance is limited and the access with a card has to be authorized.

The Visiting Instrument owner has to provide a list of potentially dangerous things such as: type of chemicals used, devices under pressure, mechanical systems to be handled with care and by specially trained manpower, requirement of cryogenics liquids for the instrument, etc.

6 Annexes

6.1 Map of La Silla

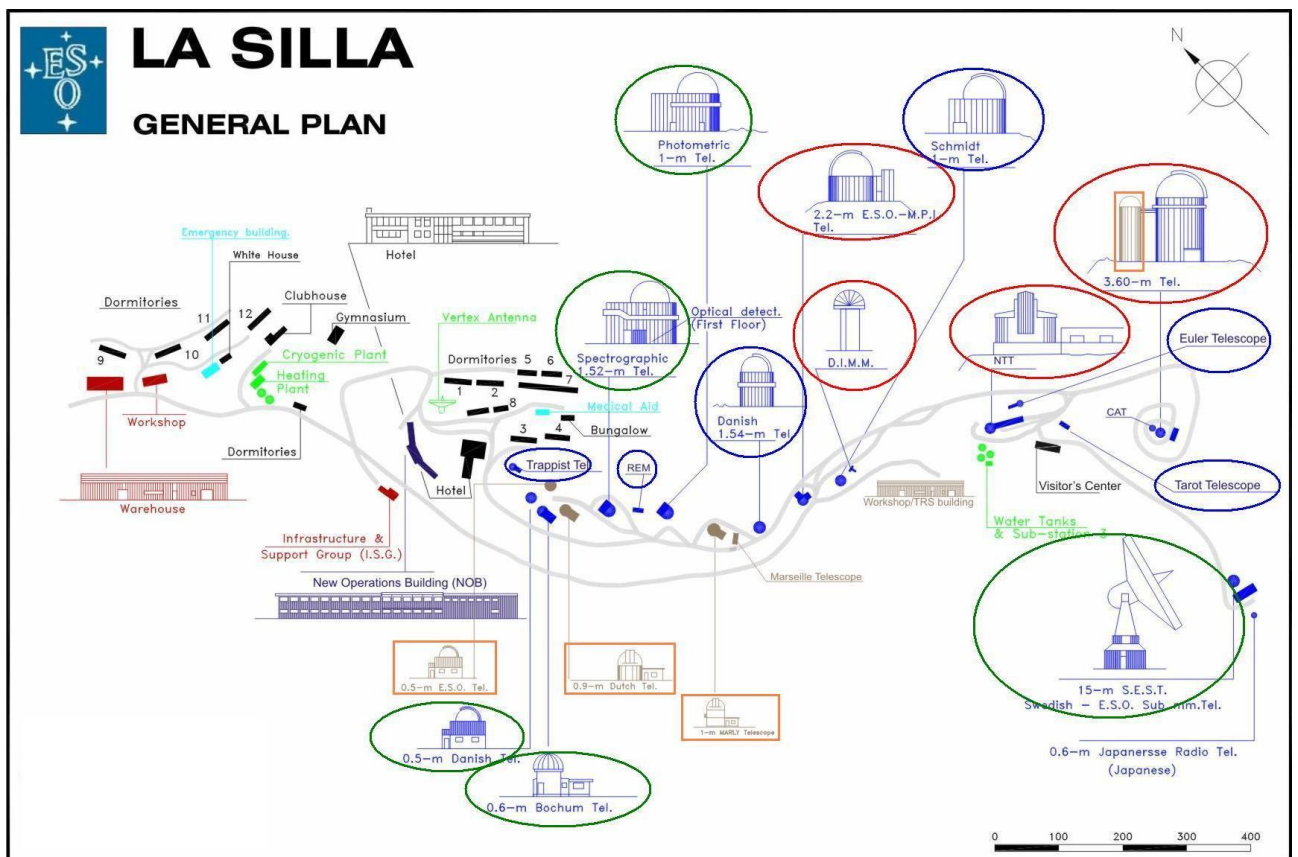

Notes:

- In Red: ESO operated telescopes
- In Blue: Operated by Institutes or Universities
- In Green: Decommissioned telescopes
- In Orange: Removed telescopes from La Silla