



European Organisation
for Astronomical
Research in the
Southern Hemisphere

Organisation Européenne
pour des Recherches
Astronomiques
dans l'Hémisphère Austral

Europäische Organisation
für astronomische
Forschung in der
südlichen Hemisphäre

VERY LARGE TELESCOPE

X-shooter User Manual

Doc. No.: VLT-MAN-ESO-14650-4942

Issue: P102v2

Date: 02.06.2018

Prepared: Andrea Mehner, Christophe Martayan, originally written by Joël Vernet & Elena Mason

Name	Date	Signature
------	------	-----------

Approved: Andreas Kaufer, originally approved by Sandro D'Odorico

Name	Date	Signature
------	------	-----------

Released: Steffen Mieske, Christophe Dumas

Name	Date	Signature
------	------	-----------



CHANGE RECORD

ISSUE	DATE	SECTION/PARA. AFFECTED	REASON/INITIATION DOCUMENTS/REMARKS
0.1	13.01.06	All	FDR version: Table of Content prepared by Céline Péroux
0.2	14.08.08	All	PAE version prepared by Joël Vernet
1	01.03.09	All	First release prepared by Joël Vernet, with contributions by Elena Mason
2	01.07.09	All	Prepared by Joël Vernet and Elena Mason. - Added description of IFU centring and tracking wavelength - Updated all TSF. - Added spectrograph orientation figure. - Added description of Threshold Limited Integration in the NIR - Added information about ghost spectra - Added information about slit/ifu position in acq image header. - Updated limiting mags with measured NIR sensitivity and background between OH lines in VIS - Updated UVB/VIS/NIR detector parameters - Added warning about 2x2 binning mode and inter-order bck subtraction
2.1	15.01.2010	Section 5 Sections 2.4.3 and 3.3.1	- Templates name changed from SHOOT to XSHOOTER; default and hidden parameters. - plus sparse minor corrections.
86.1	09.02.2010	None	cmmModule creation
87	26.08.2010	All	CMA, modified many sections.



88	<p>27.02.2011 01.03.2011 03.03.2011 07.03.2011 28.03.2011 20.06.2011</p>	<p>Modified sects. 1.3, 2.2.1.3, 2.2.4.2, 2.3.2, 2.4, 2.4.3, 2.4.4, 2.4.6.1, 2.4.7, 3, 3.2, 3.3.1, 3.3.2, 3.3.3, 3.3.4, 4.1.1, 5, 5.1, 5.6.1, 5.6.2, 5.7, 5.9, 6.1.3, 6.2.3 New Sects 2.4.10, 2.4.11, 2.4.12, 2.4.13, 2.4.13, 2.4.14, 3.4, 3.4.1, 3.4.2, 3.4.3, 3.4.4, 3.4.5, 3.4.6 Modified tables: 2, 7, 11, 12, 66 New tables: 10, 13 Modified figures: 10, 15 New figures: 5, 11 New subsections 2.4.6, 6.1.3</p>	<p>CMA, update wrt the performances, new identified problems and status + description of the current ones. New items in the FAQ, new calibration plan, new section about the observation strategy. Figures updated to be more clear and useful. NIR 1.5" slit removed. Intervention of July 2011 briefly described+additional corrections of figures and sections according to IOT comments. Very minor changes. New templates added + minor corrections.</p>
89	<p>04.08.2011 30.11.2011</p>	<p>Modified Sections: 2.1, 2.2.1.4, 2.2.4.2, 2.2.4.5, 2.3.2, 2.4.6, 2.4.9, 2.4.13, 2.4.15, 3.4.1, 5.1, 5.5, 5.7, 6.1.5, 6.2.3. New sections: 2.2.4.3, 2.4.7 Modified tables: 1, 9, 12, 13, 16, 72 New tables: 3, 4, 10</p>	<p>CMA, major modifications wrt the new slits in the NIR + new slits with K-band blocking filter added and background performances + the new TCCD performances + the new calibration plan + clarification of different points (attached calibrations, known problems, etc), weblinks. Modifications regarding phase2 + changes for the acquisition + setup + readout + wiping overheads. Additional information regarding integration times for the TCCD.</p>
90	<p>20.02.2012 03.04.2012</p>	<p>Modified sections: 2.2.1.4, 2.2.4.5, 2.4.3, 3.4.3, 4.1.2, 5.1, 5.4, Table 16 revised. Clarification of 2.2.4.3 (new NIR slits) New 6.1.2 for better explanation of slit orientation and offsets.</p>	<p>DIT of 1800s with JH slits, TCCD limiting magnitudes + direct acquisition. Telluric std star observations. How to minimize the overheads and optimize the integration times. Calibration plan revised. Phase 2: minor modifications + new drawings. Other minor adjustments of tables and links.</p>



90/91	08.08.2012	No ADCs mode: sect. 2.2.2, updates of sects. 2.4.2, 24.13-1.4.15, 3.1, 3.4.3, 5.7, 5.9	Adding a new section about the observations without ADCs (2.2.2). More info for the IFU. Updates wrt the telluric std star policy starting in P91.
91	09.10.2012		Transmission curve of the K-band blocking filter added. Telluric std star policy updated for P91.
91/92	10.02.2013	Section 3.2 split in 2: 3.2.1 3.2.2 New section 3.3 New section 1.6	Sects 3.2.1/3.2.2: main acq loop and 3.2.2 blind offset precision. New section 3.3 about examples of OBs preparation with p2pp3 especially regarding the acqs (direct or blind offsets). New section 1.6 regarding the acknowledgements. Warning about the snapshots during the acquisitions offsets that will not be saved anymore. Warning about the exposure times of all calibration frames that will be revised. Warning about the wavelength calibration at night.
P92			Change of format .doc to .odt, allowed 2dmap wave calibrations at night. Move of XSHOOTER from UT2 to UT3. Minor changes in various sections.
P93			Back to format .doc. Introduction of the XSHOOTER imaging mode. Minor changes.
P94	26.02.2014		Minor changes. New table about the limiting magnitude for a S/N=10. Some details provided for the dichroic dip oscillation, corrected cross-references.
	30.06.2014	All	CMA: Merging imaging mode manual with main manual as per ESO standard. Obsolete sections removed or reorganized. Radial velocity accuracy added. Updates of references and features.



P95	20.11.2014		Updates in 1.8, 2.2.2, new 2.4.7, 2.4.14.
P96	26.02.2015		Homogenizing the overheads. Mapping templates information.
	24.06.2015		Offset convention, info about mapping tpl, imaging mode (Pelletier cooling effect).
P97	19.08.2015	New sect. 2.4.15	Minor editing for P97 phase1 + historical wavelength shifts.
	16.01.2016	All	Major editing throughout the manual.
	20.02.2016	All	Minor edits.
P98	17.09.2016	All	Minor corrections and edits.
	27.01.2017	Tables 1 and 11.	Spectral resolving powers.
P100	01.03.2017	Sections 3.3.3, 4.7	Change in standard calibration plan regarding tellurics.
P100	11.06.2017	Several sections	Updates regarding the ADCs after the installation of the new ADC drives and resuming operation with working ADCs.
P101	30.08.2017	Several sections	Updates regarding night time calibration plan and IFU mode.
P101	24.11.2017	Several sections	Updates regarding night time calibration plan.
P102	12.02.2018	Several sections	Updated the spectral resolving power.



TABLE OF CONTENTS

1	Introduction.....	10
1.1	Scope.....	11
1.2	X-shooter in a nutshell.....	11
1.3	Shortcuts to most relevant facts for proposal preparation.....	11
1.4	List of Abbreviations & Acronyms.....	12
1.5	Reference documents.....	13
1.6	Acknowledgements.....	13
1.7	Contact.....	13
1.8	News.....	13
2	Technical description of the instrument.....	14
2.1	Overview of the opto-mechanical design.....	14
2.2	Description of the instrument sub-systems.....	15
2.2.1	The Backbone.....	15
2.2.1.1	The instrument shutter and the calibration unit.....	15
2.2.1.2	The Acquisition and Guiding slide.....	16
2.2.1.3	The IFU.....	16
2.2.1.4	The Acquisition and Guiding camera.....	16
2.2.1.5	The dichroic box.....	19
2.2.1.6	The flexure compensation tip-tilt mirrors.....	19
2.2.1.7	The focal reducer and the ADCs.....	19
2.2.2	The UVB spectrograph.....	20
2.2.2.1	Slit carriage.....	20
2.2.2.2	Optical layout.....	20
2.2.2.3	Detector.....	21
2.2.3	The VIS spectrograph.....	23
2.2.3.1	Slit carriage.....	23
2.2.3.2	Optical layout.....	23
2.2.3.3	Detector.....	24
2.2.4	The NIR spectrograph.....	24
2.2.4.1	Pre-slit optics and entrance window.....	24
2.2.4.2	Slit wheels.....	24
2.2.4.3	Optical layout.....	25
2.2.4.4	NIR background.....	26
2.2.4.5	Detector.....	27
2.3	Spectral format, resolution, and performances.....	29
2.3.1	Spectral format.....	29
2.3.2	Spectral resolution and sampling.....	29
2.3.3	Sensitivity.....	29
2.4	Instrument features and known problems.....	33
2.4.1	UVB and VIS detectors sequential readout.....	33
2.4.2	Disabled ADCs.....	33
2.4.3	Remnants.....	34
2.4.4	Ghosts.....	37
2.4.5	Inter-order background.....	37
2.4.6	Features in NIR frames with the K-band blocking filter.....	38
2.4.7	NIR detector: inter-quadrant cross-talk and electrical ghosts.....	38
2.4.8	Instrument stability (backbone and spectrograph flexures).....	39
2.4.9	Radial velocity accuracy.....	39
2.4.10	NIR 11th order vignetting.....	39



2.4.11	VIS CCD pick-up noise	39
2.4.12	NIR IFU parasitic reflections	40
2.4.13	Drift of acquisition reference positions	40
2.4.14	Wavelength shift between arms	40
2.4.15	A&G TCCD features	40
3	Observing with X-shooter	42
3.1	Target acquisition	42
3.1.1	The acquisition loop	42
3.1.2	Blind offset precision	43
3.2	Observing modes	43
3.2.1	Staring (SLT and IFU)	43
3.2.2	Staring synchronized (SLT and IFU)	44
3.2.3	Nodding along the slit (SLT)	44
3.2.4	Fixed offset to sky (SLT and IFU)	45
3.2.5	Generic offset (SLT and IFU)	45
3.2.6	Mapping (SLT and IFU)	45
3.2.7	Imaging	45
3.2.7.1	Detector characteristics, filters, and zeropoints	45
3.2.7.2	Stability of the A&G TCCD	49
3.2.7.3	Calibration plan and observing strategies	50
3.2.7.4	Distortion map, fringes, and astrometric accuracy	51
3.3	Observation strategies	53
3.3.1	Instrument setup	53
3.3.2	Observation strategy	53
3.3.3	Telluric standard stars and telluric lines correction	54
3.3.4	Effects of atmospheric dispersion	55
3.3.5	Exposure times in the NIR arm	55
3.3.6	Readout times in the UVB and VIS arms: minimization of overheads	56
3.3.7	Observations of bright targets	56
3.4	Instrument and telescope overheads	56
4	Calibrating and reducing X-shooter data	58
4.1	X-shooter calibration plan	58
4.2	Wavelength and spatial scale calibrations	60
4.3	Flatfield calibrations	61
4.4	Spectroscopic skyflats	61
4.5	Attached calibrations	61
4.6	Spectrophotometric calibration	62
4.7	Telluric lines correction	62
4.8	The ESO X-shooter pipeline	63
4.9	Frequently Asked Questions	64
5	Reference material	66
5.1	Templates	66
5.1.1	Orientation and offset conventions	66
5.1.2	SLT and IFU acquisition templates	69
5.1.3	Flexure compensation templates	72
5.1.4	Science templates	72
5.1.4.1	SLT observation templates	72
5.1.4.2	IFU observation templates	75
5.1.5	Night-time calibration templates	77
5.1.5.1	Spectrophotometric standard stars	77
5.1.5.2	Telluric standard stars	80



5.1.5.3	Attached night-time calibrations.....	82
5.1.6	Daytime calibration templates.....	84
5.1.6.1	SLT and IFU arcs (resolution, tilt).....	84
5.1.6.2	Flatfield (pixel response, orders localization).....	85
5.1.6.3	Format check (1 st guess of wavelength solution).....	87
5.1.6.4	Order definition (1 st guess of order localization).....	88
5.1.6.5	Multi-pinhole arcs.....	88
5.1.6.6	Detector calibrations.....	89
5.1.6.7	Imaging templates.....	91
5.2	Slit masks.....	94

1 Introduction

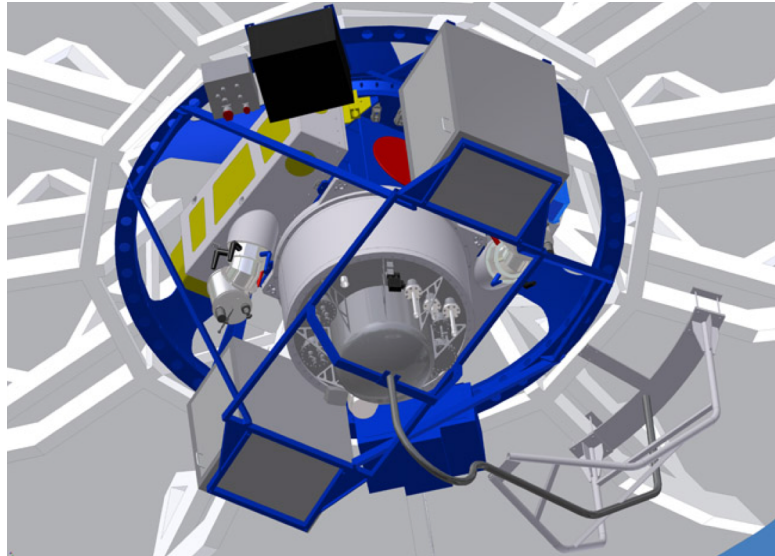

Figure 1: 3D CAD view of the X-shooter spectrograph at the Cassegrain focus of one of the VLT Unit Telescopes.

Table 1: X-shooter characteristics and observing capabilities.

Wavelength range	300-2500 nm split in 3 arms
UV-blue arm	Range: 300-550 nm in 12 orders Resolution: 5400 (1" slit) Slit width: 0.5", 0.8", 1.0", 1.3", 1.6", 5.0" Detector: 4kx2k E2V CCD
Visual-red arm	Range: 550-1000 nm in 14 orders Resolution: 8900 (0.9" slit) Slit width: 0.4", 0.7", 0.9", 1.2", 1.5", 5.0" Detector: 4kx2k MIT/LL CCD
Near-IR arm	Range: 1000-2500 nm in 16 orders Resolution: 5600 (0.9" slit) Slit width: 0.4", 0.6", 0.9", 1.2", 5.0", 0.6" JH, 0.9" JH Detector: 2kx1k Hawaii 2RG
Slit length	11" (SLT) or 12.6" (IFU)
Beam separation	Two high efficiency dichroics
Atmospheric dispersion compensation	In the UVB and VIS arms (disabled on Aug. 1st, 2012)
Integral field unit	1.8"x4" reformatted into 0.6"x12"
Acquisition and guiding camera	1.5'x1.5' + Johnson and SDSS filters



1.1 Scope

The X-shooter User Manual provides extensive information on the technical characteristics of the instrument, its performances, observing, calibration procedures, and data reduction.

1.2 X-shooter in a nutshell

X-shooter is a single target spectrograph for the Cassegrain focus of one of the VLT UTs covering in a single exposure the spectral range from the UV to the K band. The spectral format is fixed. The instrument is designed to maximize the sensitivity in the spectral range through the splitting in three arms with optimized optics, coatings, dispersive elements, and detectors. It operates at intermediate resolutions ($R = 2000-18000$, depending on wavelength and slit width), sufficient to address quantitatively a vast number of astrophysical applications while working in a background-limited S/N regime in the regions of the spectrum free from strong atmospheric emission and absorption lines.

A 3D CAD view of the instrument attached to the telescope is shown in Figure 1. Main instrument characteristics are summarized in Table 1. A consortium involving institutes from Denmark, Italy, The Netherlands, France, and ESO built X-shooter. The names of the institutes and their respective contributions are given in Table 2.

Table 2: Collaborating institutes and their contributions.

Collaborating institutes	Contribution
Copenhagen University Observatory	Backbone unit, UVB spectrograph, mechanical design and FEA, control electronics
ESO	Project management and systems engineering, detectors, final system integration, commissioning, logistics, data reduction software
Paris-Meudon Observatory, Paris VII University	Integral Field Unit, data reduction software
INAF - Observatories of Brera, Catania, Trieste and Palermo	UVB and VIS spectrograph, instrument control software, opto-mechanical design
Astron, Universities of Amsterdam and Nijmegen	NIR spectrograph, contribution to data reduction software

1.3 Shortcuts to most relevant facts for proposal preparation

- The fixed **spectral format** of X-shooter: see Table 12 on page 32
- **Spectral resolution** as a function of slit width: see Table 11 on page 30
- Information on the **IFU**: see Section 2.2.1.3 on page 16
- Information on **limiting magnitudes** in the continuum: see Section 2.3.3 on page 29
- Information on **observing modes**: see Section 3.2 on page 43
- Observing strategy and **sky subtraction**: see Section 3.3 on page 53
- **Overhead** computation: see Section 3.4 on page 56



1.4 List of Abbreviations & Acronyms

This document employs several abbreviations and acronyms to refer concisely to an item, after it has been introduced. The following list is aimed to help the reader in recalling the extended meaning of each short expression:

A&G/AG	Acquisition and Guiding
ADC	Atmospheric Dispersion Compensator
AFC	Active Flexure Compensation
DCS	Detector Control Software
DEC	Declination
DFS	Data Flow System
DIT	Detector Integration Time
ESO	European Southern Observatory
ETC	Exposure Time Calculator
FDR	Final Design Review
FF	Flat Field
GUI	Graphical User Interface
ICS	Instrument Control Software
IFU	Integral Field Unit
ISF	Instrument Summary File
IWS	Instrument Workstation
LCU	Local Control Unit
N/A	Not Applicable
OB	Observing Block
PAE	Preliminary Acceptance Europe
P2PP	Phase 2 Proposal Preparation
RA	Right Ascension
RMS	Root Mean Square
RON	Readout Noise
SM	Service Mode
TBC	To Be Clarified
TCCD	Technical CCD
QE	Quantum Efficiency
SNR	Signal to Noise Ratio
TBD	To Be Defined
TCS	Telescope Control Software
TLI	Threshold Limited Integration
TSF	Template Signature File
VLT	Very Large Telescope
VM	Visitor Mode
WCS	World Coordinate System
ZP	Zeropoint



1.5 Reference documents

1. X-shooter Calibration plan, v1.0, XSH-PLA-ESO-12000-0088
2. X-shooter Templates Reference Manual, v0.2, XSH-MAN-ITA-8000-0031
3. X-shooter technical note about the 11th order vignetting in K band
4. X-shooter article: Vernet et al. [2011A&A...536A.105V](#)
5. Report about the non destructive NIR readout mode
<http://www.eso.org/sci/facilities/paranal/instruments/xshooter/doc/reportNDreadoutpublic.pdf>
6. X-shooter imaging mode Messenger article: [Martayan et al. \(2014\)](#)
7. Report about the historical wavelength shift between arms: [Moehler et al. \(2015\)](#)

1.6 Acknowledgements

Please, consider citing the following articles if you publish X-shooter data:

1. Main instrument article:

Vernet et al., [2011A&A...536A.105V](#), *X-shooter, the new wide band intermediate resolution spectrograph at the ESO Very Large Telescope*

2. Flux calibration:

Vernet et al., [2010HiA....15..535V](#), *Building-up a database of spectro-photometric standards from the UV to the NIR*

Hamuy et al., [1994PASP..106..566H](#), *Southern spectrophotometric standards, 2*

3. Pipeline and data reduction:

Modigliani et al., [2010SPIE.7737E..56M](#), *The X-shooter pipeline*

4. Reflex interface:

Freudling et al., [2013A&A...559A..96F](#), *Automated data reduction workflows for astronomy. The ESO Reflex environment*

5. Imaging mode:

Martayan et al., [2014Msngr.156...21M](#), *The X-shooter Imaging Mode*

1.7 Contact

For instrument related questions, please contact xshooter@eso.org. For phase1 and phase2 related questions, please contact usd_xshooter@eso.org or usd-help@eso.org.

1.8 News

Please check the news page of X-shooter for recent news:

<https://www.eso.org/sci/facilities/paranal/instruments/xshooter/news.html>.

2 Technical description of the instrument

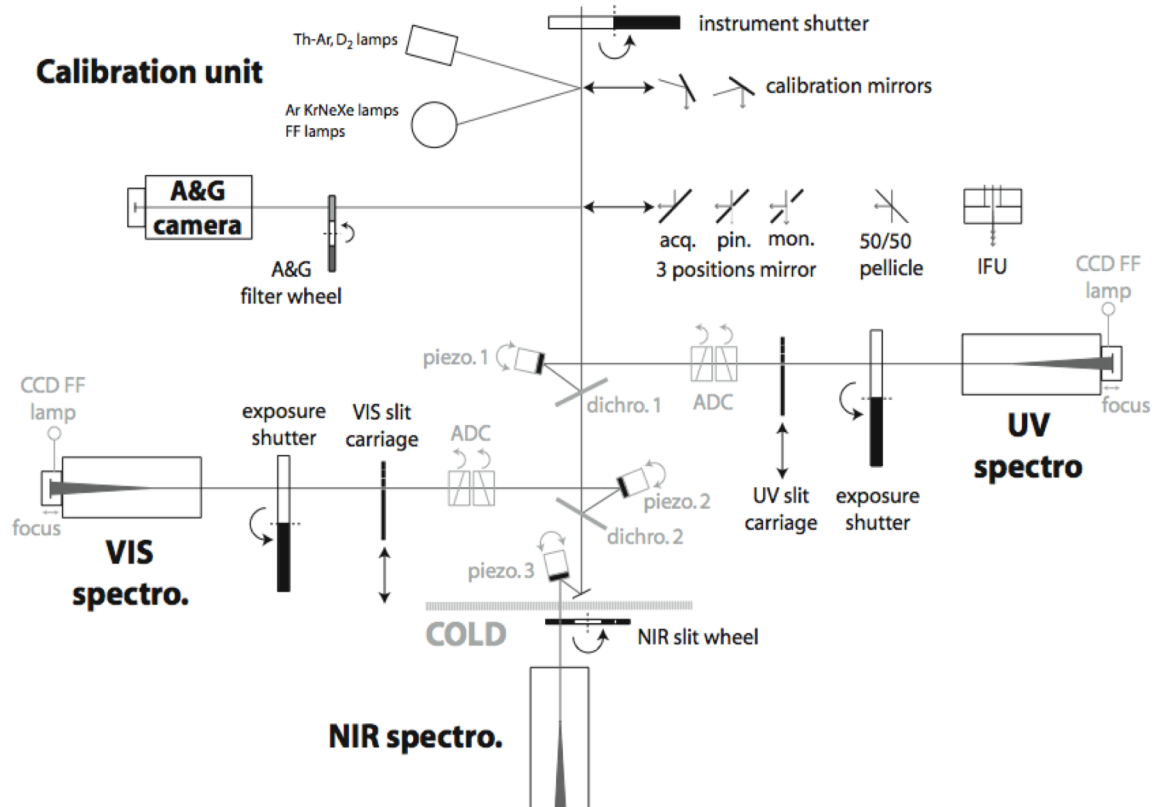

Figure 2: Schematic overview of the opto-mechanical design of X-shooter.

2.1 Overview of the opto-mechanical design

Figure 2 shows a schematic view of the layout of the instrument. X-shooter consists of four main components:

- The backbone is directly mounted on the Cassegrain derotator of the telescope. It contains all pre-slit optics: the calibration unit, a slide with the 3-positions mirror and the IFU, the acquisition and guiding (A&G) camera, the dichroic box which splits the light between the three arms, one piezo tip-tilt mirror for each arm to allow active compensation of backbone flexures, atmospheric dispersion compensators (ADCs) in the UVB and VIS arms, and a warm optical box in the NIR arm.
- The three arms are fixed format cross-dispersed échelle spectrographs that operate in parallel. Each one has its own slit selection device.
 - The UV-Blue spectrograph covers the 300-550 nm wavelength range with a resolving power of 5400 (for a 1" slit).
 - The VIS spectrograph covers the range 550-1000 nm with a resolving power of 8900 (0.9" slit).

- The near-IR spectrograph covers the range 1000-2500 nm with a resolving power of 5600 (0.9" slit). It is fully cryogenic.

2.2 Description of the instrument sub-systems

This section describes the different sub-systems of X-shooter in the order they are encountered along the optical path from the telescope to the detectors. The functionalities of the different sub-units are explained and reference is made to their measured performance.

2.2.1 The Backbone

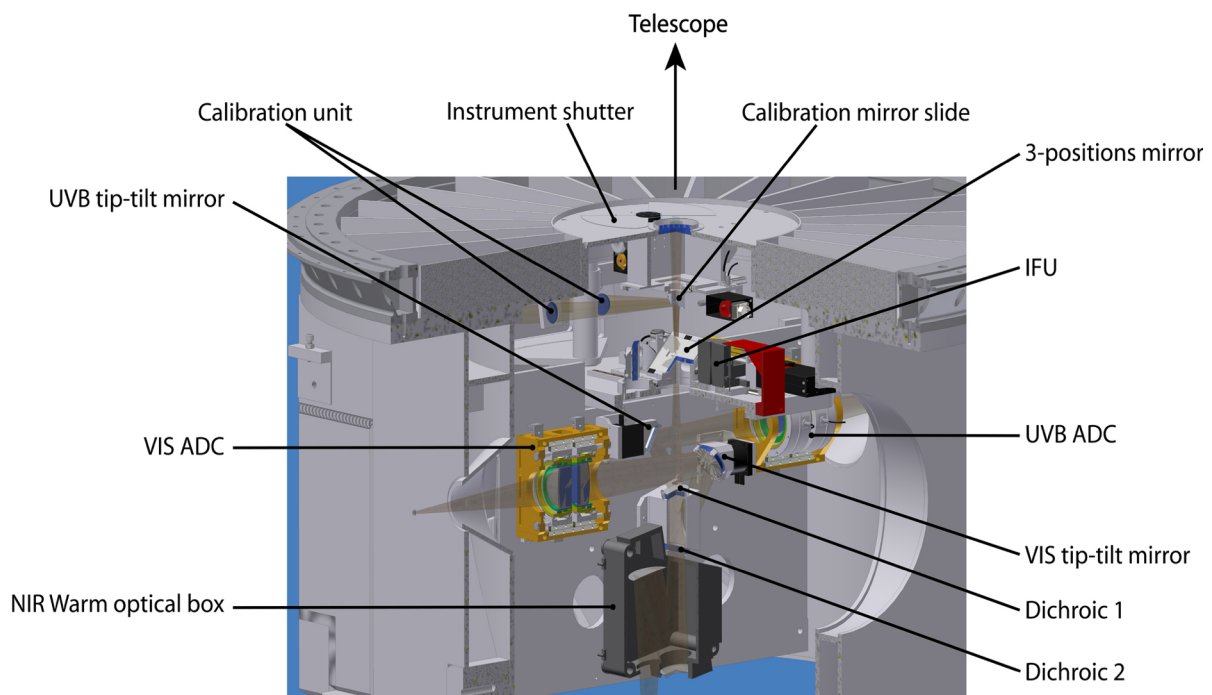

Figure 3: 3D view of a cut through the backbone.

2.2.1.1 The instrument shutter and the calibration unit

In the converging beam coming from the telescope, the first element is the telescope entrance shutter. Then follows the calibration unit which contains flatfielding and wavelength calibration lamps. This unit consists of a mechanical structure with calibration lamps, an integrating sphere, relay optics that simulate the $f/13.6$ telescope beam, and a mirror slide with 3 positions that can be inserted in the telescope beam:

- one free position for a direct feed from the telescope
- one mirror which reflects the light from the integrating sphere equipped with:
 - wavelength calibration Ar, Hg, Ne, and Xe Penray lamps operating simultaneously
 - three flatfield halogen lamps equipped with different balancing filters to optimize the spectral energy distribution for each arm
- one mirror which reflects light from
 - a wavelength calibration hollow cathode ThAr lamp



- a D₂ lamp for flatfielding the bluest part of the UV-Blue spectral range
- A detailed description of the functionalities of the calibration system is given in Section 4.

2.2.1.2 The Acquisition and Guiding slide

Light coming either directly from the telescope or from the calibration unit described above reaches first the A&G slide. This structure allows putting into the beam either:

- A flat 45° mirror with 3 positions mirror:
 - *Acquisition and imaging*: send the full 1.5'×1.5' field of view to the A&G camera. This is the position used during all acquisition sequences.
 - *Spectroscopic observations and monitoring*: a slot lets the central 10"×15" of the field go through to the spectrographs while reflecting the peripheral field to the A&G camera. This is the position used for all science observations.
 - *Artificial star*: a 0.5" pinhole used for optical alignment and engineering purposes.
- The IFU.
- A 50/50 pellicle beam splitter at 45°, which is used to look down into the instrument with the A&G camera and is exclusively used for engineering purposes.

2.2.1.3 The IFU

The Integral Field Unit is an image slicer that re-images an input field of 4"×1.8" into a pseudo slit of 12"×0.6". The light from the central slice is directly transmitted to the spectrographs. The two lateral sliced fields are reflected toward the two pairs of spherical mirrors and realigned at both ends of the central slice in order to form the exit slit as illustrated in Figure 4. Due to these four reflections the throughput of the two lateral fields is reduced with respect to the directly transmitted central one. The measured overall efficiency of the two lateral slitlets is ~85% of the direct transmission but drops to ~50% below 400 nm due to reduced coating efficiency in the blue. An example of an IFU standard star is shown in Figure 5.

2.2.1.4 The Acquisition and Guiding camera

The A&G camera allows to visually detect and center objects from the U to the z band. The unit consists in:

- A filter wheel equipped with a full UBVRI Johnson filter set and a full Sloan Digital Sky Survey (SDSS) filter set. Transmission curves are provided in Section 3.2.7.
- A Pelletier cooled, 13 μm pixel, 512×512 E2V broad band coated Technical CCD57-10 onto which the focal plane is re-imaged at f/1.91 through a focal reducer. This setup provides a plate scale of 0.1766"/pix and a field of view of 1.47'×1.47'. The QE curve of the detector is provided in Section 3.2.7.

The A&G camera provides a good enough sampling to centroid targets to < 0.1" accuracy in all seeing conditions. The noise of the technical CCD is RON = 4.1 e⁻. The limiting magnitudes for direct acquisitions are listed in Table 3. For acquisitions in the Johnson filters, blind offset acquisition is required for targets fainter than 22 mag. For acquisitions in the SDSS filters, we recommend a limiting magnitude of 20 mag for direct acquisition in i_{prime} and z_{prime}, and 21 mag in the other filters. For blind offsets, we recommend to select a reference star with a magnitude of about 19 mag or brighter to ensure a good centering before the offsets.

See Section 3.2.7 for information about the imaging mode facility.

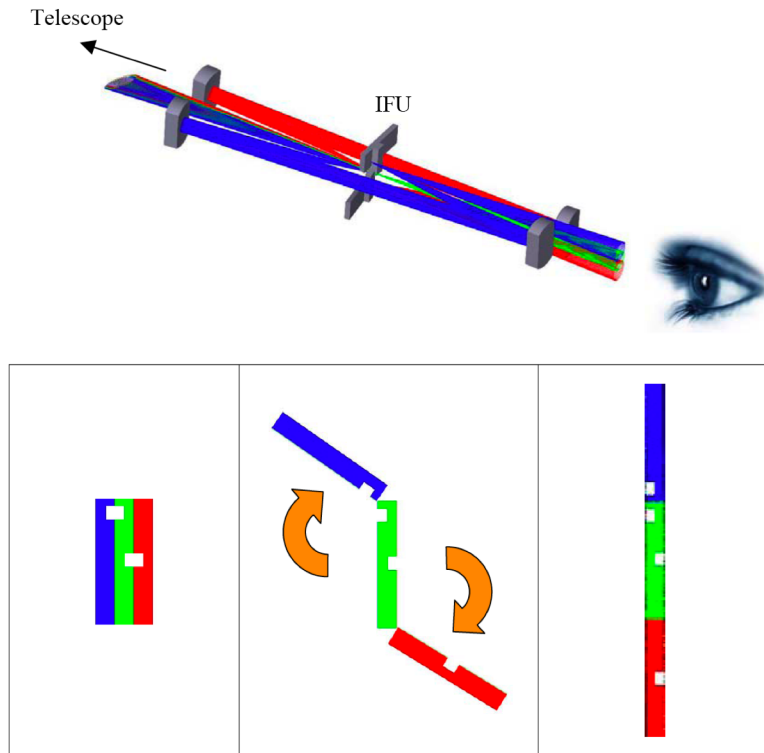

Figure 4: Effect of the IFU. The central field is directly transmitted to form the central slitlet (green), while each lateral field (blue and red) is reflected toward a pair of spherical mirrors and realigned at the end of the central slice to form the exit slit. The field before the IFU is displayed on the left. The IFU acts such that the lateral fields seem to rotate around a corner of their small edge. The field after the IFU is displayed on the right. The white slots are guides to help visualize the top and the bottom of each slice in the drawing.

Table 3: Limiting magnitudes for direct acquisition (TCCD exposure times of 60-120 s).

Band	U	B	V	R	I
Limiting magnitude (mag)	22	22	22.5	22.5	22.5
Band	u_prime	g_prime	r_prime	i_prime	z_prime
Limiting magnitude (mag)	21	21	21	20	20

Recommended exposure times for the acquisition:

V = 6 mag: 0.001 s

V = 7 mag: 0.005 s

V = 16-20 mag: 1 to 5 s

V = 23 mag: 60-120 s

V >= 24 mag: ≥ 180 s

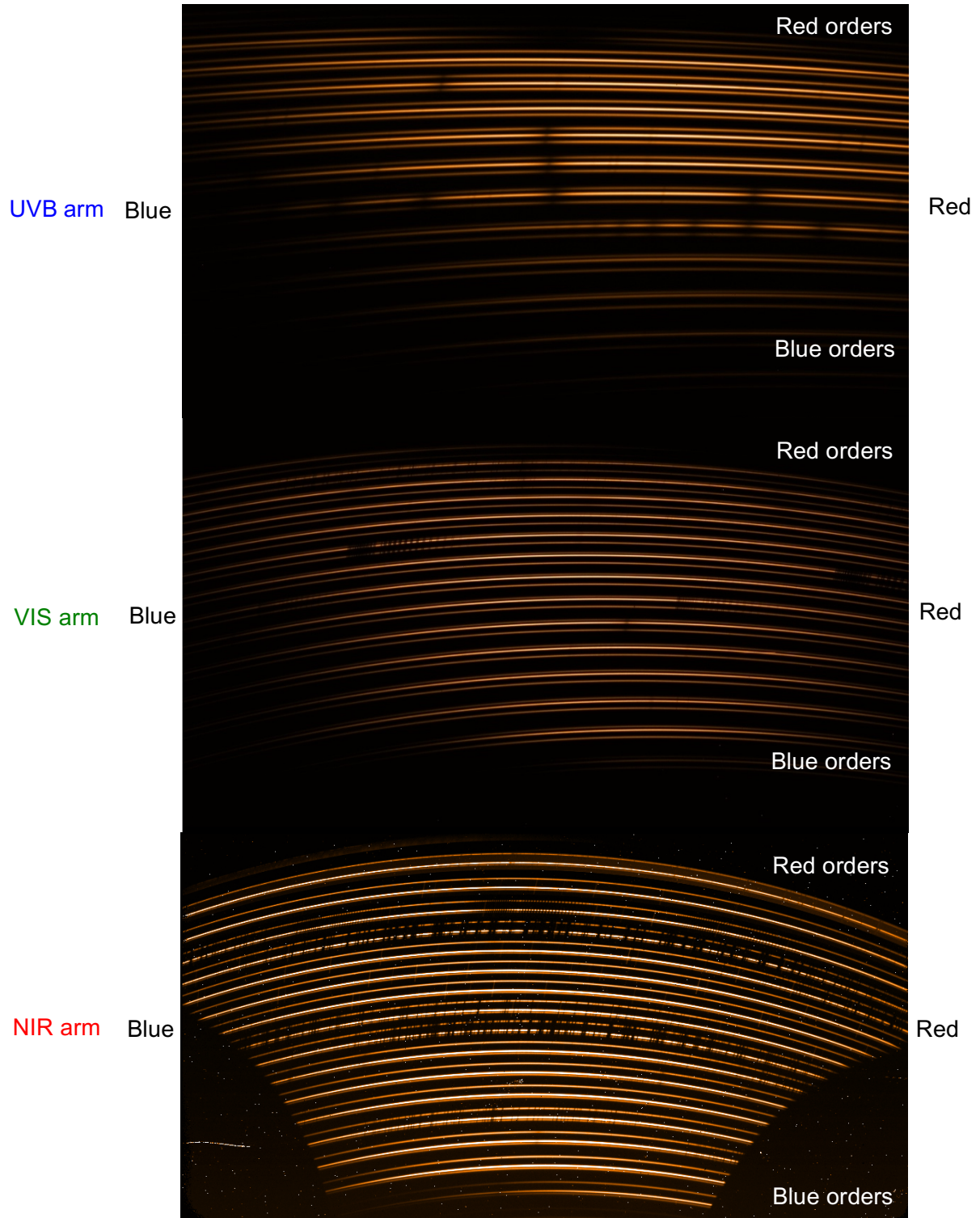

Figure 5: IFU observation showing the three slices in each order. The telluric absorption lines are visible in the VIS and NIR. One can also observe the effect of the atmospheric dispersion (change of distance between the slices between blue and red orders in the UVB/VIS arms).

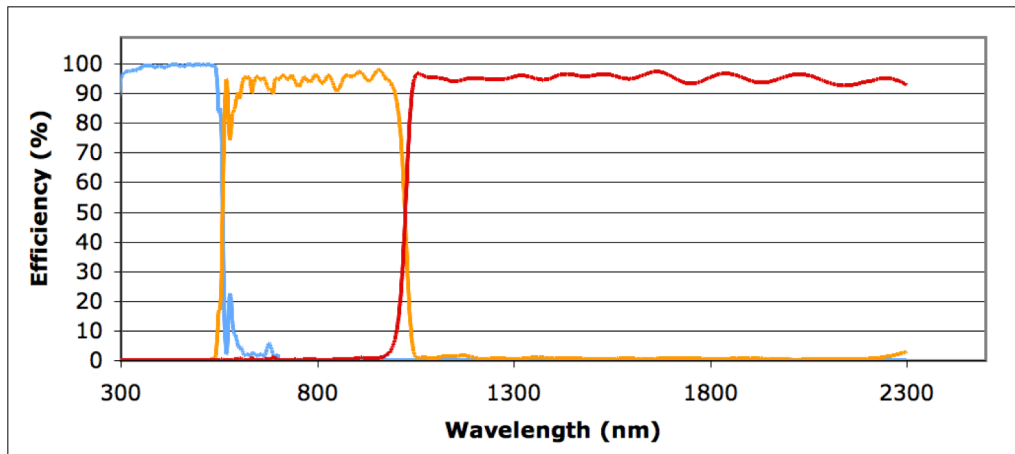

Figure 6: The combined efficiency of the two dichroic beam splitters. Reflection on dichroic 1 (blue); transmission through dichroic 1 and reflection on dichroic 2 (orange); transmission through dichroics 1 and 2 (red).

2.2.1.5 The dichroic box

Light is split and distributed to the three arms by two highly efficient dichroic beam splitters. The first dichroic at an incidence angle of 15° reflects more than 98% of the light between 350 nm and 543 nm and transmits $\sim 95\%$ of the light between 600 nm and 2300 nm. The second dichroic, also at 15° incidence, has a reflectivity above 98% between 535 nm and 985 nm and transmits more than 96% of the light between 1045 nm and 2300 nm. The combined efficiency of the two dichroics is shown in Figure 6. It is well above 90% over most of the spectral range.

2.2.1.6 The flexure compensation tip-tilt mirrors

The light reflected and/or transmitted by the two dichroics encounters then a folding mirror mounted on piezo tip-tilt mount. These mirrors are used to fold the beam and correct for backbone flexure to keep the relative alignment of the three spectrograph slits within less than $0.02''$ at any position of the instrument. They also compensate for shifts due to atmospheric differential refraction between the telescope tracking wavelength (fixed at 470 nm for all SLIT observations) and the undeviated wavelength of the two ADCs (for UVB and VIS arms) and the middle of the atmospheric dispersion range for the NIR arm. In case of IFU observations, one can select the telescope tracking wavelength.

2.2.1.7 The focal reducer and the ADCs

Both UVB and VIS pre-slit arms contain a focal reducer and an ADC. These focal reducer-ADCs consist of two doublets cemented onto two counter rotating double prisms. The focal reducers bring the focal ratio from $f/13.41$ to $\sim f/6.5$ and provide a measured plate scale at the entrance slit of the spectrographs of $3.91''/\text{mm}$ in the UVB and $3.82''/\text{mm}$ in the VIS.

The ADCs compensate for atmospheric dispersion in order to minimize slit losses and allow orienting the slit to any position angle on the sky up to a zenith distance of 60° . The zero-deviation wavelengths are 405 nm and 633 nm for the UVB and the VIS ADCs, respectively. In the AUTO mode, their position is updated every 60 s based on information taken from the telescope database. *Due to mechanical problems, they were disabled between August 1st 2012 and May 2017.*



The NIR arm is not equipped with an ADC. The NIR arm tip-tilt mirror compensates for atmospheric refraction between the telescope tracking wavelength (470 nm) and 1310 nm, which corresponds to the middle of the atmospheric dispersion range for the NIR arm. This means that this wavelength is kept at the center of the NIR slit. At a zenithal distance of 60° the spectrum is dispersed by the atmosphere to 0.35", so the extremes of the spectrum can be displaced with respect to the center of the slit by up to 0.175". If measurement of absolute flux is an important issue, the slit should be placed at parallactic angle.

2.2.2 The UVB spectrograph

2.2.2.1 Slit carriage

The first opto-mechanical element of the spectrograph is the slit carriage. Besides the slit selection mechanism, this unit consists of a field lens placed just in front of the slit to re-image the telescope pupil onto the spectrograph grating, and the spectrograph shutter just after the slit. The slit mask is a laser cut Invar plate manufactured with the LPKF Laser Cutter used for FORS and VIMOS. It is mounted on a motorized slide in order to select one of the 9 positions available. All science observation slits are 11" high and different widths from 0.5" to 5" are offered. In addition, a single pinhole for spectral format check and order tracing and a 9-pinhole mask for wavelength calibration and spatial scale mapping are available (see Table 4).

Table 4: UVB spectrograph slits and calibration masks.

Size	Purpose
0.5"×11" slit	SCI / CAL
0.8"×11" slit	SCI / CAL
1.0"×11" slit	SCI / CAL
1.3"×11" slit	SCI / CAL
1.6"×11" slit	SCI / CAL
5.0"×11" slit	CAL
Row of 9 pinholes of 0.5" ∅ spaced at 1.4"	CAL
0.5" ∅ pinhole	CAL

2.2.2.2 Optical layout

The optical layout of the UVB spectrograph is presented in Figure 7. Light from the entrance slit, placed behind the plane of the figure, feeds a 5° off-axis Maksutov-type collimator through a folding mirror. The collimator consists of a spherical mirror and a diverging fused silica corrector lens with only spherical surfaces. The collimated beam passes through a 60° silica prism twice to gain enough cross-dispersion. Main dispersion is achieved through a 180 grooves/mm échelle grating blazed at 41.77°. The off-blaze angle is 0.0°, while the off-plane angle is 2.2°. After dispersion, the collimator creates an intermediate spectrum near the entrance slit, where a second folding mirror has been placed. This folding mirror acts also as field mirror. Then a dioptric camera (4 lens groups with CaF₂ or silica lenses, 1 aspherical surface) reimages the cross-dispersed spectrum at f/2.7 (plate scale 9.31"/mm) onto a detector that is slightly tilted to compensate for a variation of best focus with wavelength.

The back focal length is rather sensitive to temperature changes. It varies by ~22.7 μm/°C which corresponds to a defocus of 9 μm/°C or ~0.08"/°C. This is automatically compensated at the beginning of every exposure by moving the triplet + doublet of the camera by -10.9 μm/°C.

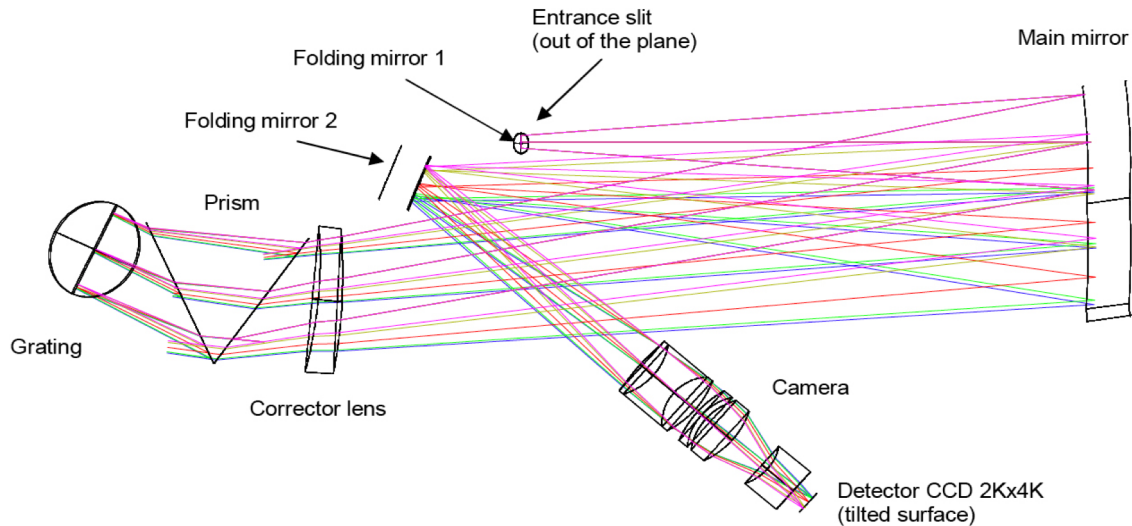

Figure 7: The UVB spectrograph optical layout.

2.2.2.3 Detector

The UVB detector is a 2048×4102, 15 μm pixel CCD from E2V (type CCD44-82) of which only a 1800×3000 pixels window is used. The CCD cryostat is attached to the camera with the last optical element acting as a window. The operating temperature is 153 K. The CCD control system is a standard ESO FIERA controller shared with the VIS CCD. The list of readout modes and their properties is given in Table 5. One more readout mode (1000×1000 window, low gain, fast readout, 1x1 binning) exclusively used for flexure measurement and engineering purposes is also implemented. The detector shutter, located just after the slit is a 25 mm bi-stable (2 coil, zero dissipation) shutter from Uniblitz (type BDS 25). Full transit time is 13 ms. Since the slit is 2.8 mm high (11" at f/6.5), the illumination of the detector is homogenous within << 10 ms.

Figure 8 shows the UVB and VIS detector QE curves. A summary of detector properties and performances is given in Table 6.

Table 5: List of detector readout modes offered for science observations.

Readout mode name	Gain [e-/ADU]		Speed [kpix/s]	Binning	
	UVB	VIS		Spatial dir.	Dispersion dir.
100k/1pt/hg	High [0.62]	High [0.595]	Slow [100]	1	1
100k/1pt/hg/1x2				1	2
100k/1pt/hg/2x2*				2	2
400k/1pt/lg	Low [1.75]	Low [1.4]	Fast [400]	1	1
400k/1pt/lg/1x2				1	2
400k/1pt/lg/2x2*				2	2

*The 2x2 binning is not recommended in the VIS when a good inter-order background subtraction is required.



Table 6: Measured properties of the X-shooter detectors.

	UVB	VIS	NIR
Detector type	E2V CCD44-82	MIT/LL CCID 20	substrate removed Hawaii 2RG
Operating temperature	153 K	135 K	79 K
QE	80% at 320 nm 88% at 400 nm 83% at 500 nm 81% at 540 nm	78% at 550 nm 91% at 700 nm 74% at 900 nm 23% at 1000 nm	85%
Number of pixels	2048x3000 (2048x4102 used in windowed readout)	2048x4096	2048x2048 (1024x2048 used)
Pixel size	15 μm	15 μm	18 μm
Gain (e^-/ADU)	High: 0.62 Low: 1.75	High: 0.595 Low: 1.4	2.12
Readout noise ($e^- \text{ rms}$)	Slow: 2.5 Fast: 4.5	Slow: 3.1 Fast: 5.2	Short DIT: ~25 DIT > 300s: ~8.0
Saturation (ADU)	65000	65000	45000 (for a single readout). TLI: 42000 ADUs used for long DITs
Full frame readout time (s)	1x1, slow-fast: 68-16 1x2, slow-fast: 34-8 2x2, slow-fast: 17-4	1x1, slow-fast: 89-21 1x2, slow-fast: 45-11 2x2, slow-fast: 22-5	1.46 (for a single readout)
Dark current level	< 0.2 $e^-/\text{pix}/\text{h}$	< 1.1 $e^-/\text{pix}/\text{h}$	21 $e^-/\text{pix}/\text{h}$
Fringing amplitude	-	~5% peak-to-valley	-
Non-linearity	Slow: 0.4% Fast: 1.0%	Slow: 0.8% Fast: 0.8%	< 1% up to 45000 ADUs
Readout direction	Main disp. dir.	Main disp. dir.	-
Prescan and overscan areas	1x1 and 1x2: X=1-48 and 2097-2144 2x2: X = 1-24 and 1049-1072	1x1 and 1x2: pix 39-48 and 2097-2144 2x2: X = 19-24 and 1049-1072	-
Flatness	< 8 μm peak-to-valley		

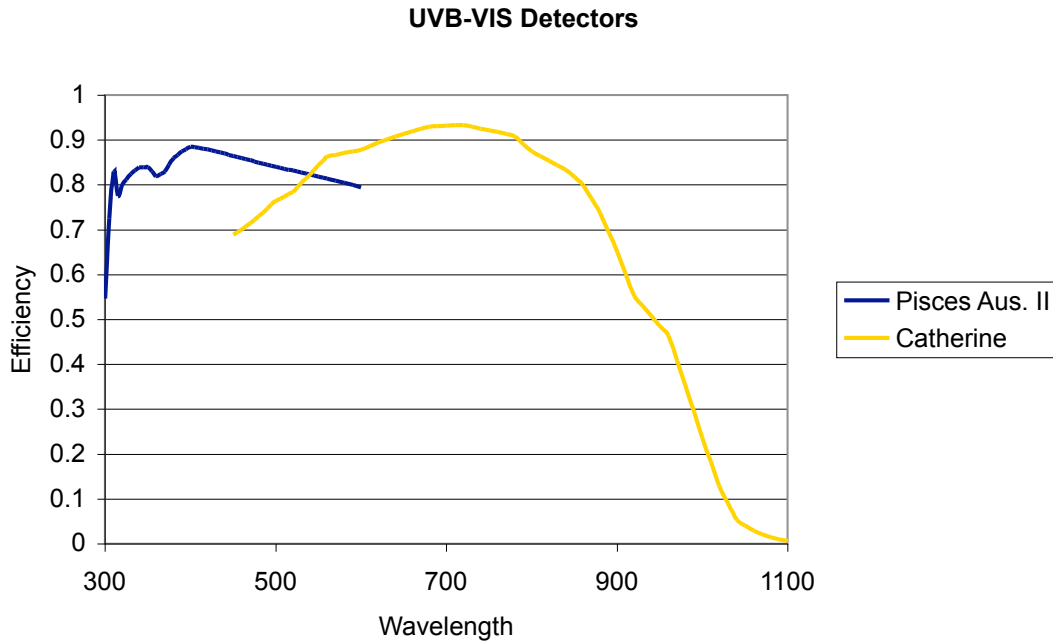

Figure 8: UVB/VIS detector efficiency.

2.2.3 The VIS spectrograph

2.2.3.1 Slit carriage

The slit carriage of the VIS spectrograph is identical to that of the UVB, but the available slits are different. All science observation slits are 11" high and different widths are offered from 0.4" to 5" (Table 7).

Table 7: VIS spectrograph slits and calibration masks.

Size	Purpose
0.4"×11" slit	SCI / CAL
0.7"×11" slit	SCI / CAL
0.9"×11" slit	SCI / CAL
1.2"×11" slit	SCI / CAL
1.5"×11" slit	SCI / CAL
5.0"×11" slit	CAL
Row of 9 pinholes of 0.5" \varnothing spaced at 1.4"	CAL
0.5" \varnothing pinhole	CAL

2.2.3.2 Optical layout

The optical layout of the VIS spectrograph is very similar to that of the UVB (Figure 7). The collimator (mirror + corrector lens) is identical. For cross-dispersion, it uses a 49° Schott SF6 prism in double pass. The main dispersion is achieved through a 99.4 grooves/mm, 54.0° blaze échelle grating. The off-blaze angle is 0.0° and the off-plane angle is 2.0°. The camera (3 lens groups, 1 aspherical surface) re-images the cross-dispersed spectrum at f/2.8 (plate scale 8.98"/mm) onto the detector (not tilted). Focusing is obtained by acting on the triplet + doublet sub-unit of the camera. However, unlike the UVB arm, the back focal length varies less than 1 $\mu\text{m}/^\circ\text{C}$ (image blur < 0.004"/°C) hence no thermal focus compensation is needed.



2.2.3.3 Detector

The VIS detector is a 2048×4096, 15 μm pixel CCD from MIT/LL (type CCID-20). Like for the UVB arm, the cryostat is attached to the camera with the last optical element acting as a window. The operating temperature is 135 K. It shares its controller with the UVB detector and the same readout modes are available (Table 5). Measured properties and performances are given in Table 6. The shutter system is identical to the UVB one.

2.2.4 The NIR spectrograph

The NIR spectrograph is fully cryogenic. It is cooled with a liquid nitrogen bath cryostat and operates at 79 K.

2.2.4.1 Pre-slit optics and entrance window

After the dichroic box and two warm mirrors M1 (cylindrical) and M2 (spherical, mounted on a tip-tilt stage and used for flexure compensation) light enters the cryostat via the Infrasil vacuum window. To avoid ghosts, this window is tilted 3 degrees about the Y-axis. After the window, light passes the cold stop, and is directed towards the entrance slit via two folding mirrors M3 (flat) and M4 (spherical).

2.2.4.2 Slit wheels

A circular laser cut Invar slit mask is pressed in between two stainless steel disks with 12 openings forming the wheel. The wheel is positioned by indents on the circumference of the wheel with a roll clicking into the indents. All the science observation slits are 11" high and different widths are offered from 0.4" to 5" (Table 8). In July 2011, the 1.5" slit was removed and two new slits of 0.6" and 0.9" with a stray-light K-band blocking filter were added to the slit wheel. Scattered light from the strong thermal radiation in the reddest order of the NIR arm affects very significantly the background level in the J and H bands. These new slits offer the possibility of low background observations in the J and H bands with the expense of wavelength coverage (i.e., cutting the K-band). The 0.6" and 0.9" slits with the full wavelength coverage are still offered. The resolving power of the K-band blocking filter slits is slightly different.

Table 8: NIR spectrograph slits and calibration masks.

Size	Purpose
0.4"×11" slit	SCI / CAL
0.6"×11" slit	SCI / CAL
0.9"×11" slit	SCI / CAL
1.2"×11" slit	SCI / CAL
5.0"×11" slit	CAL
0.6"×11" JH slit [#]	SCI / CAL
0.9"×11" JH slit [#]	SCI / CAL
Row of 9 pinholes of 0.5" Ø spaced at 1.4"	CAL
0.5" Ø pinhole	CAL
Blind*	SCI / CAL

*The Blind position can be set in case the NIR arm will be highly saturated to do not damage the detector and avoid remnants. It is also used for measurements of the instrumental background.

Table 9: NIR spectrograph slits and resolving power.

Slit	R old slit wheel	R new slit wheel
0.4"	11000	11600
0.6"	7950	8100
0.6"JH*	-	8100
0.9"	5700	5600
0.9"JH*	-	5600
1.2"	3990	4300
1.5"	2540	-
5"	-	1600
IFU	8400	8300

*slits with the K-band blocking filter.

2.2.4.3 Optical layout

The optical layout of the NIR spectrograph is presented in Figure 9. The conceptual design is the same than for the UVB and the VIS spectrographs. Light entering the spectrograph via the entrance slit and folding mirror M5 feeds an off-axis Maksutov-inspired collimator. The collimator is made of two spherical mirrors M6 and M7 plus an Infrasil corrector lens (with only spherical surfaces). In order to get enough cross dispersion, three prisms are used in double path. Prism 1 is a 35° top angle made of Infrasil; prisms 2 and 3 are two 22° top angle ZnSe prisms. This design provides an almost constant order separation. Main dispersion is provided by a 55 grooves/mm échelle grating with a blaze angle of 46.07°. The off-blaze angle is 0.0°, while the off-plane angle is 1.8°. After dispersion, the collimator creates an intermediate spectrum near the entrance slit, where M8, a spherical mirror, acts as a field mirror, relocating the pupil between L2 and L3, the last lenses of the camera. The fixed focus camera re-images the échellogramme onto the detector at f/2.1 (plate scale 12.1"/mm).

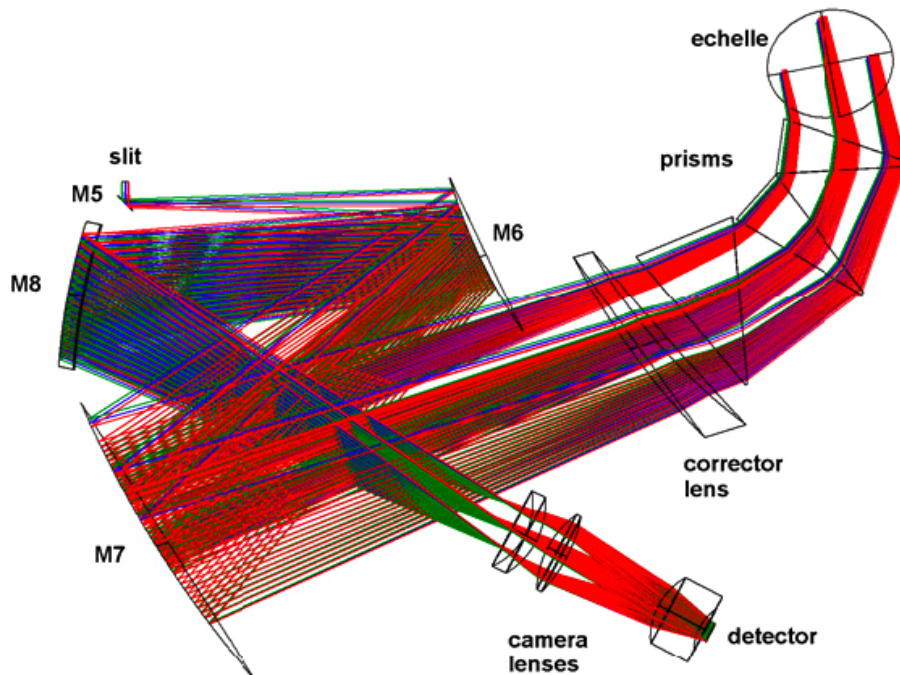

Figure 9: The NIR spectrograph optical layout.

2.2.4.4 NIR background

Table 10 provides information on the background of the 0.6" JH and 0.9" JH slits (with the K-band blocking filter) compared to the background of the normal 0.6" and 0.9" slits. With the K-band blocking filter the background is reduced in J and H bands by factors of three to four. At 1300 nm, for the slits with the K-band blocking filter the background is sky limited (not taking into account the RON). Figure 13 and Figure 14 show the noise contributions (thermal background, RON, sky background, dark current) as a function of DIT for the 0.9" and 0.6" slits with and without K-band blocking at different wavelengths.

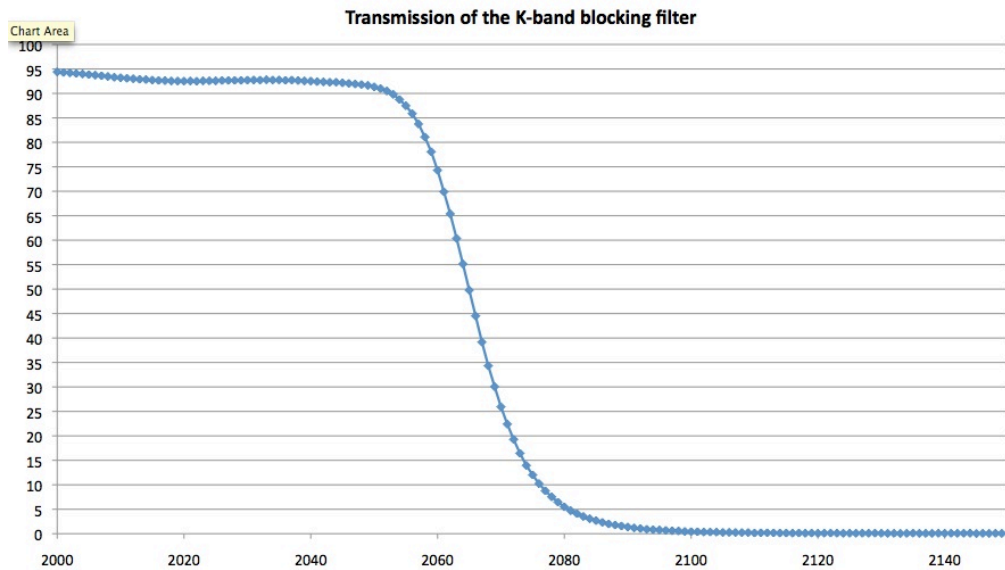

Figure 10: Transmission curve of the K-band blocking filter.

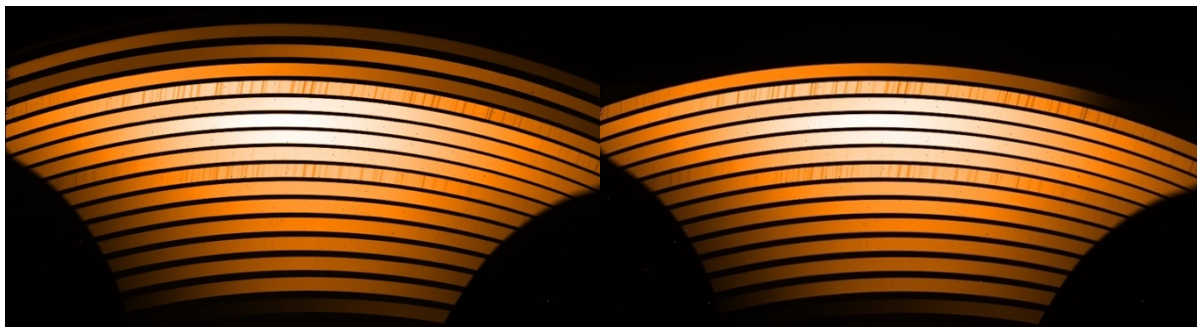

Figure 11: Flatfield frames for the normal 0.9" NIR slit (left) and for the 0.9" with K-band blocking filter (right). One can easily note that the last orders are cut with the K-band blocking filter.

Table 10: Background measurements of the slits with and without K-band blocking filter. The measurements were normalized to a 1" slit.

Wavelength (nm)	Background with filter (e-/s/pix)	Background without filter (e-/s/pix)	Reduction (%)	Reduction factor	Sky darktime (e-/s/pix)
1048	0.02	0.06	65	2.9	0.02
1238	0.03	0.10	73	3.7	0.02

1300	0.04	0.13	73	3.7	0.04
1682	0.04	0.15	73	3.8	0.05

2.2.4.5 Detector

The NIR detector is a Teledyne substrate-removed HgCdTe, 2k×2k, 18 μm pixel Hawaii 2RG from of which only 1k×2k is used. It is operated at 79 K. Measured characteristics and performances are given in Table 6. Sample-up-the-ramp (non-destructive) readout is always used. This means that during integration, the detector is continuously read out without resetting it and counts in each pixel are computed by fitting the slope of the signal versus time. In addition, Threshold Limited Integration (TLI) mode is used to extend the dynamical range for long exposure times: if one pixel reaches an absolute value above a certain threshold (close to detector saturation), only detector readouts before the threshold is reached are used to compute the slope and the counts written in the FITS image for this pixel are extrapolated to the full exposure time (Finger et al. 2008, Proc. SPIE, Vol. 7021).

Warning: Adjacent pixels can follow different regimes, one pixel can follow the normal regime and its neighboring pixel can follow the extrapolated regime. This could lead to bad line profiles, which may affect, e.g., chemical abundance determinations. We strongly recommend to use exposure times small enough that the counts never reach 89000 e⁻ (42000 ADUs). A document explaining this readout mode is available at:

<http://www.eso.org/sci/facilities/paranal/instruments/xshooter/doc/reportNDreadoutpublic.pdf>

For operational reasons only a limited number of DITs are offered to the user (see Section 3.3.5).

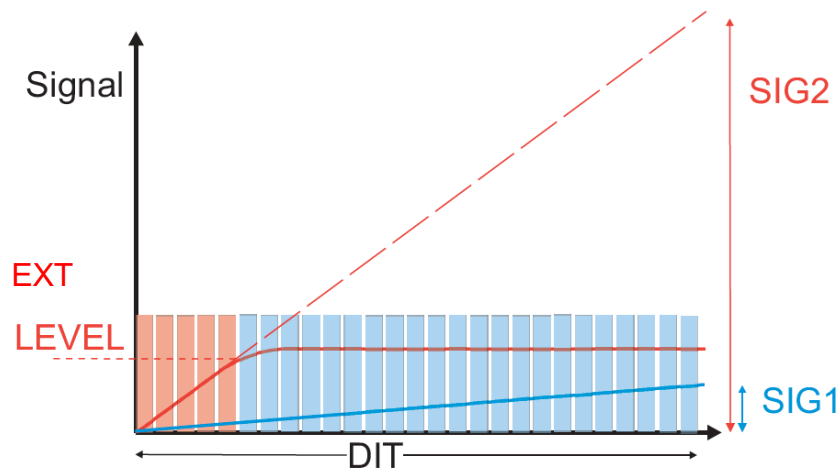

Figure 12: Extrapolation threshold for non-destructive sampling and extrapolation of detector signal for high flux levels. For pixels with high flux (red) only readout values below EXTLEVEL (orange rectangles) are taken into account in the calculation of the slope and values written in the FITS files are extrapolated to the full DIT (SIG2). For low flux pixels (blue) all nondestructive readouts are used (light blue rectangles). Modified figure coming from Finger et al. (2008).

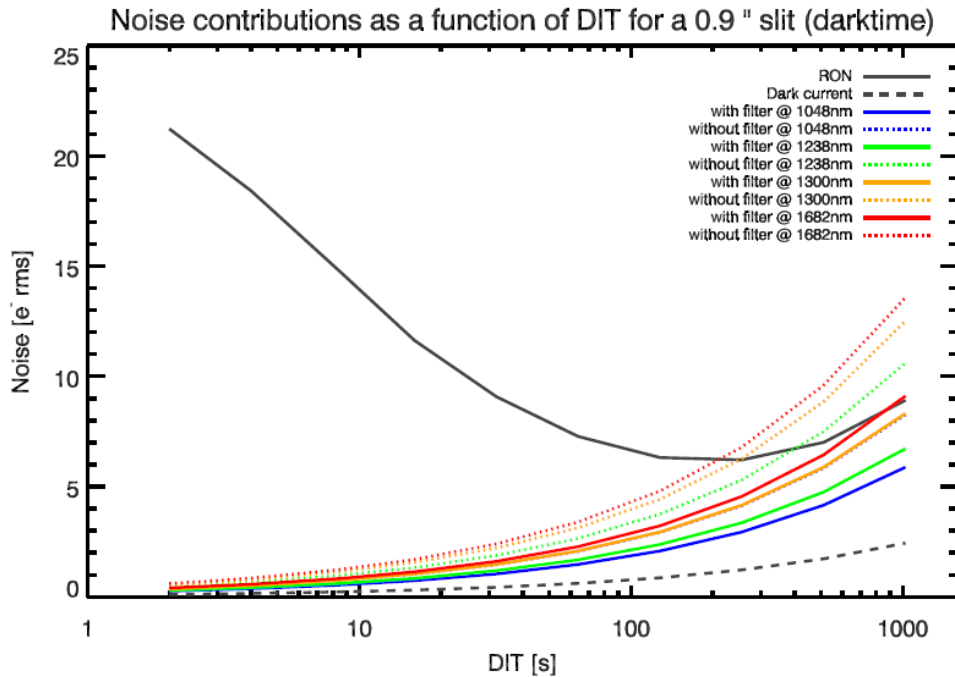

Figure 13: Noise contributions as a function of DIT for the 0.9" slit. For the 0.9" slit with K-band blocking filter the background is always RON limited for DITs shorter than 1000 s independent on the wavelength. For DITs longer than 1000 s, the background is sky limited at least above 1682 nm. For the 0.9" slit without K-band blocking filter the background is RON limited for DIT up to 200 s to 300 s at wavelengths 1682 nm and 1300 nm. For longer DITs the background is sky limited.

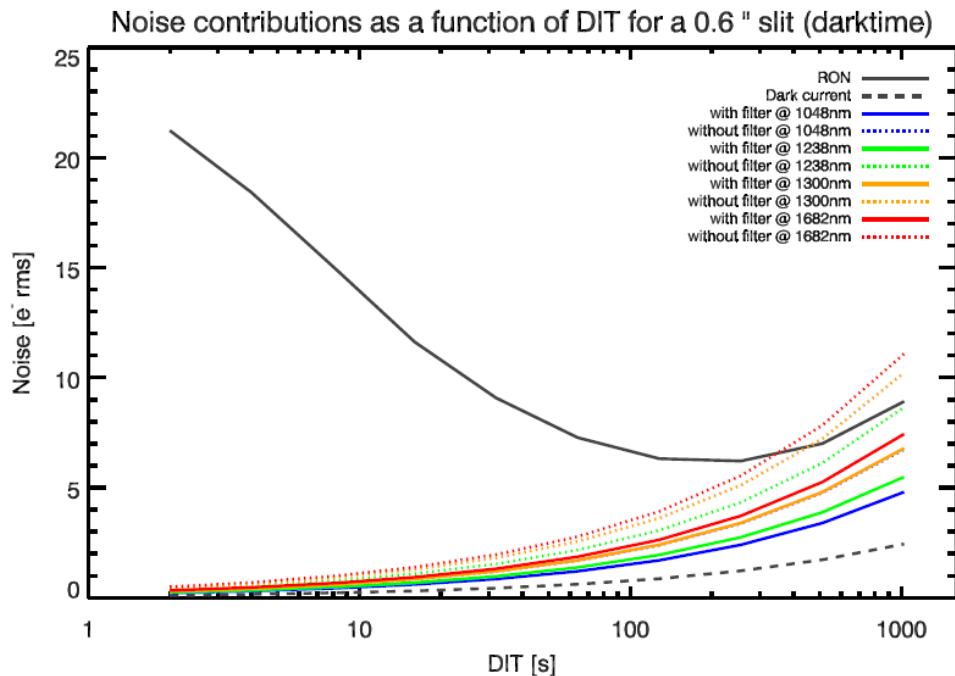

Figure 14: Noise contributions as a function of DIT for a 0.6" slit. For the 0.6" slit with K-band blocking filter the background is always RON limited. For the 0.6" slit without K-band blocking filter the background is RON limited for DITs up to ~360 s at wavelength 1682 nm and 450 s at 1300nm. For longer DITs the background is sky limited.

2.3 Spectral format, resolution, and performances

2.3.1 Spectral format

The spectral format of X-shooter is fixed. The spectral range and blaze wavelength for each order are given in Table 12. An example of a ThAr frame is shown in Figure 17. The whole spectral range is covered by 12 orders in the UVB, 15 in the VIS, and 16 in the NIR. Orders are strongly curved (parabolic) and the spectral line tilt varies along orders. Both slit height and width projection also vary from order to order and along each order due to a variable anamorphic effect introduced by the prisms (crossed twice). For example, the projected slit height (11") measured at the center of an order changes from:

- UVB: 65.9 pixels (0.167"/pix) at order 14 to 70.8 pixels (0.155"/pix) at order 24
- VIS: 65.9 pixels (0.167"/pix) at order 17 to 72.0 pixels (0.153"/pix) at order 30
- NIR: 52.4 pixels (0.210"/pix) at order 11 to 59.9 pixels (0.184"/pix) at order 26

The minimum separation between orders is about 4 (unbinned) pixels to allow inter-order background evaluation.

There are dichroic crossover regions between UVB and VIS and between VIS and NIR:

- Between UVB and VIS, the combined dichroics transmit less than 80% between 556.0-563.8 nm. This falls in the UVB order 13 and the VIS order 29. The VIS order 30 gets some flux since the dichroics still reflect and transmit ~15% of the light at 550 nm.
- Between VIS and NIR, the combined dichroics transmit less than 80% of the light between 1009.5-1035 nm. This falls in the VIS order 16 and the NIR orders 26 and 25. There is an "oscillation of the dichroic dip" in the UVB and VIS arms and the instrumental response at these wavelengths is affected by environmental influences (humidity, temperature). Flat-fielding difficulties have been noticed, especially in the UVB arm beyond 556 nm.

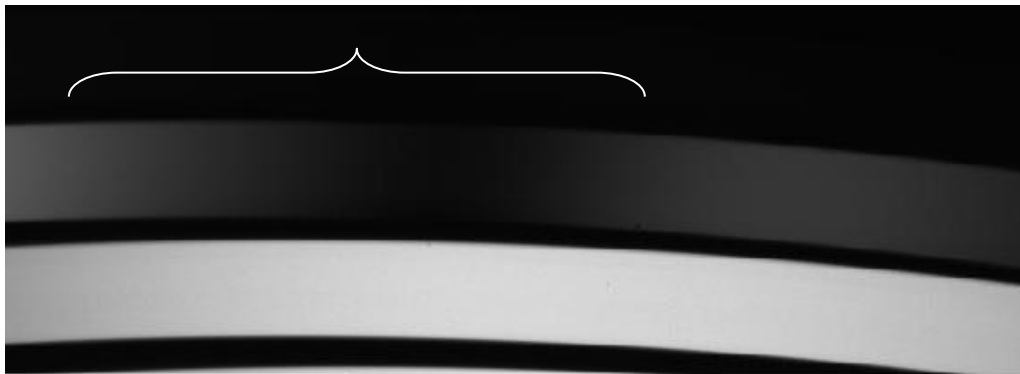

Figure 15: SLIT UVB QTH flat field. The dip due to the first dichroic is visible in the top order.

2.3.2 Spectral resolution and sampling

The user can only affect the spectral resolution through the choice of slit width (and to some extent with the binning in UVB and VIS). The resolution and pixel sampling (without binning) as a function of the slit width is given in Table 11.

2.3.3 Sensitivity

The expected limiting AB magnitudes at blaze wavelength in 1 hour for a S/N of 10 per spectral bin are given in Figure 16. Please note that a binning 2x1 is used for the UVB and VIS while there is no possibility to bin in the NIR arm.

Table 11: Resolution as a function of slit width.

UVB			VIS			NIR		
Slit width	R $\lambda/\Delta\lambda$	Sampling [pix/FWHM]	Slit width	R $\lambda/\Delta\lambda$	Sampling [pix/FWHM]	Slit width	R $\lambda/\Delta\lambda$	Sampling [pix/FWHM]
0.5	9700	2.9	0.4	18400	2.8	0.4	11600	8.4
0.8	6700	4.2	0.7	11400	4.5	0.6	8100	12.0
1.0	5400	5.2	0.9	8900	5.8	0.9	5600	17.4
1.3	4100	6.9	1.2	6500	7.9	1.2	4300	22.6
1.6	3200	8.9	1.5	5000	10.3			
IFU	8600	3.3	IFU	13500	3.8	IFU	8150	7.7

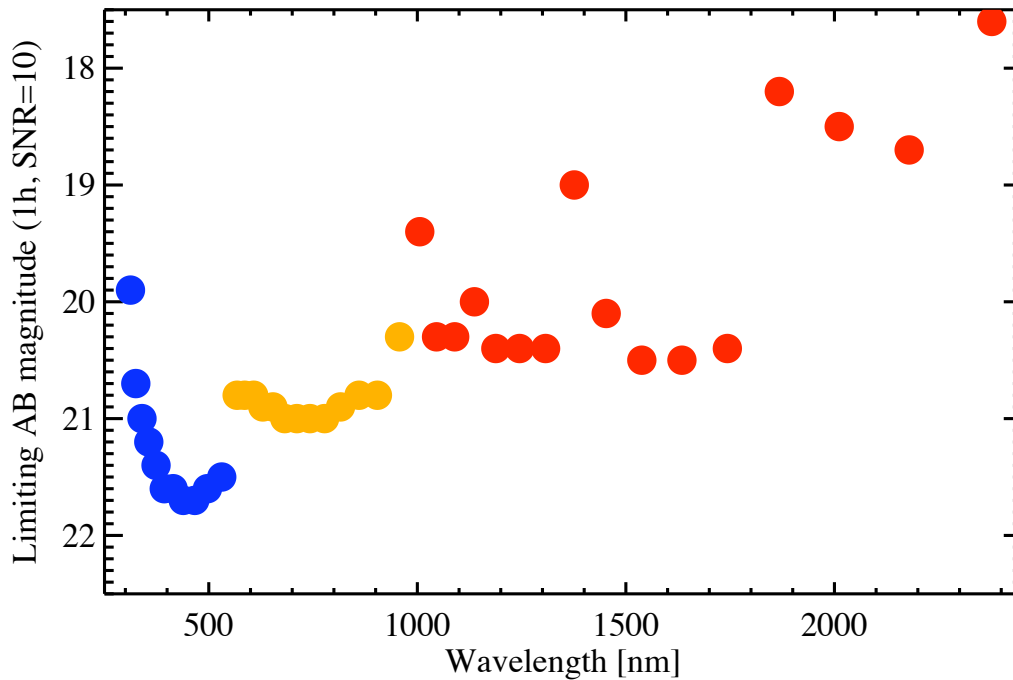

Figure 16: Limiting AB magnitude of X-shooter per spectral bin (1x2 binning) for a S/N = 10 in 1 hour exposure under average observing conditions. The decrease in efficiency in the blue of the UVB is due to atmospheric absorption, in the red of the VIS due to the decrease in CCD efficiency, and at long wavelengths in the NIR due to the rise of the thermal background.

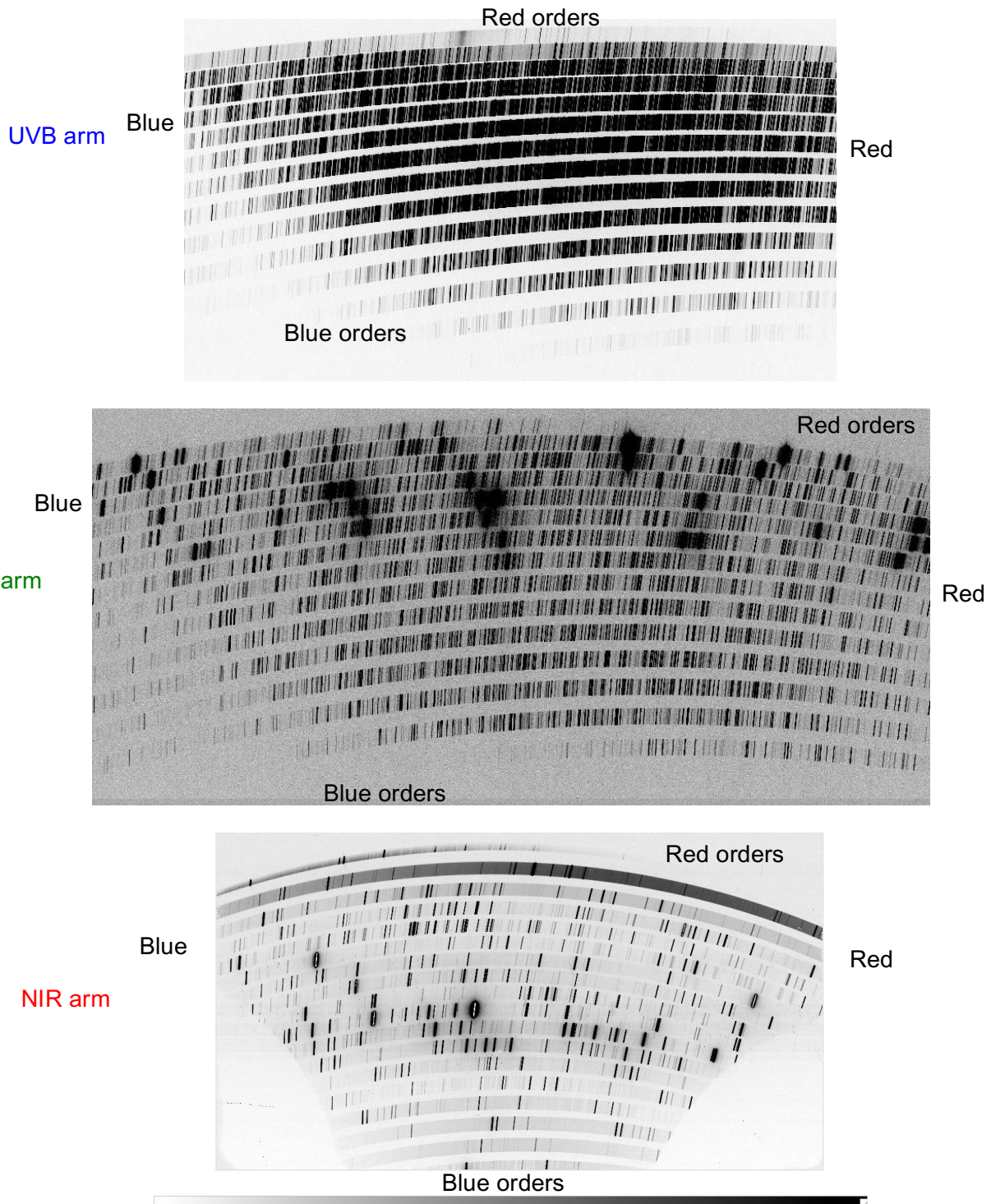

Figure 17: Example of UVB (top), VIS (middle) and NIR (bottom) calibration frames. Strong order curvature and varying slit tilt and scale are clearly visible. Note the higher thermal background at longer wavelengths for the NIR arm, in particular in the 11th order (K band).



Table 12: X-shooter spectral format.

Order	Min. wavelength [nm]	Blaze wavelength [nm]	Max. wavelength [nm]
UVB			
24	293.6	312.2	322.3
23	306.2	325.0	336.2
22	320.0	339.8	351.4
21	335.1	356.1	368.0
20	351.8	373.5	386.2
19	370.1	393.2	406.4
18	390.6	414.5	428.9
17	413.4	438.8	454.0
16	439.1	466.4	482.2
15	468.3	496.8	514.2
14	501.6	531.0	550.8
13	540.1	556.0	593.0
VIS			
30	525.3	550.5	561.0
29	535.8	568.0	580.2
28	554.6	585.9	600.8
27	575.2	607.7	622.9
26	597.4	629.5	646.8
25	621.3	653.8	672.5
24	647.2	682.1	700.4
23	675.4	711.2	730.7
22	706.1	742.6	763.8
21	739.7	777.6	800.0
20	777.0	815.8	839.8
19	817.6	860.2	883.8
18	862.9	904.3	932.7
17	913.7	957.3	987.4
16	970.7	1001.6	1048.9
NIR			
26	982.7	1005.8	1034.2
25	1020.5	1046.0	1076.7
24	1062.0	1089.6	1122.9
23	1106.6	1137.0	1173.1
22	1155.2	1188.6	1228.0
21	1208.2	1245.2	1288.5
20	1266.5	1307.5	1355.2
19	1330.3	1376.3	1429.4
18	1400.8	1452.8	1511.5
17	1479.5	1538.2	1604.0
16	1567.1	1634.4	1708.7
15	1667.8	1743.3	1823.3
14	1785.7	1867.9	1952.8
13	1922.6	2011.5	2102.0
12*	2082.9	2179.3	2275.6
11*	2272.3	2377.28	2480.7

* These orders are cut for the K-band blocking filter slits.

2.4 Instrument features and known problems

2.4.1 UVB and VIS detectors sequential readout

UVB and VIS detectors share the same FIERA controller. While both arms can expose simultaneously, the readout is done sequentially. In practice, this means that if an exposure finishes in one arm while the other one is being read out, the shutter is closed, but readout is delayed until data from the other arm are fully transferred to disk.

2.4.2 Disabled ADCs

From March to July 2012 the ADCs (Atmospheric Dispersion Correctors) for the UVB and VIS arms were occasionally failing. They showed initialization problems, especially in cold conditions. Unfortunately, the rate of these failures increased, leading in some cases to data taken in sub-optimal instrument configuration. Incorrect position of the ADCs may lead to slit losses worse than if they are not used. Consequently, the ADCs were disabled on August 1st, 2012 (set at the non-deviation position as in the IFU mode). In May 2017 redesigned ADC drives were mounted and observations resumed with working ADCs.

For observations at high airmasses slit losses can become significant if no ADCs are used. Depending on the slit widths and the seeing conditions, light at some wavelengths may not even enter the slit (Figure 18). The dispersion effect of the atmosphere depends on the telescope tracking wavelength (for X-shooter by default 470 nm) and is shown in Figure 20 for the UVB, VIS, and NIR arms. For an observation at airmass of 1.2, the drift between the blue and red order spectrum is $\sim 1.6''$ in the UVB arm, $\sim 0.6''$ in the VIS arm, and $\sim 0.2''$ in the NIR arm. For an observation at airmass 1.6, the drift between the blue and red order spectrum is $\sim 3.5''$ in the UVB arm, $\sim 0.8''$ in the VIS arm, and $\sim 0.3''$ in the NIR arm. Figure 19 is a figure from the VIMOS User Manual showing the suggested airmass limit depending of the target declination for an MOS observation at $\pm 2h$ of the meridian.

At the Cassegrain focus there is no possibility yet to perform secondary guiding. Therefore, the evolution of the parallactic angle is not followed during the exposures but the slit is aligned with the parallactic angle only at the moment of the acquisition. The slit position angle will thus deviate from atmospheric dispersion direction with time. The approximate relative evolution of the parallactic angle post-meridian crossing is shown in Figure 21 for different declinations. For example, the parallactic angle can change by 110° in 1 h for declination equals to -30° (at Paranal). For declination -50° , in 1 h the parallactic angle can change by 35° . The dispersion between the blue and the red wavelengths depends on the airmass. The airmass evolution depending on the declination of the target is shown in Figure 22.

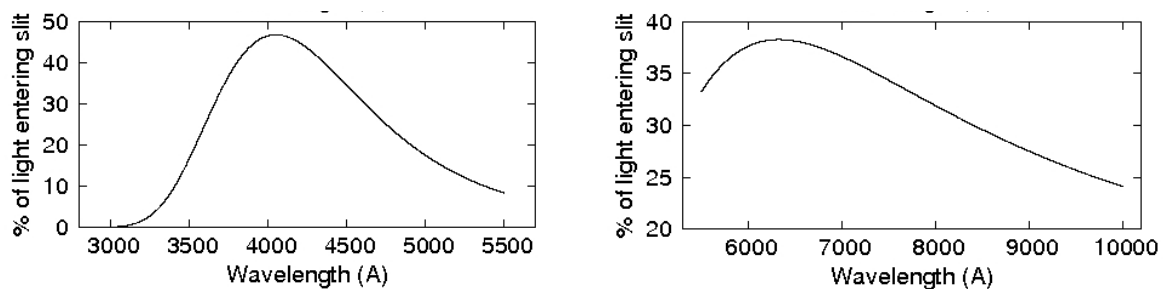

Figure 18: Percentage of light entering the slit for observations at 90° from the parallactic angle, $0.4''$ slit in the UVB arm (left), $0.5''$ slit in the VIS arm (right), and a seeing of $0.8''$.

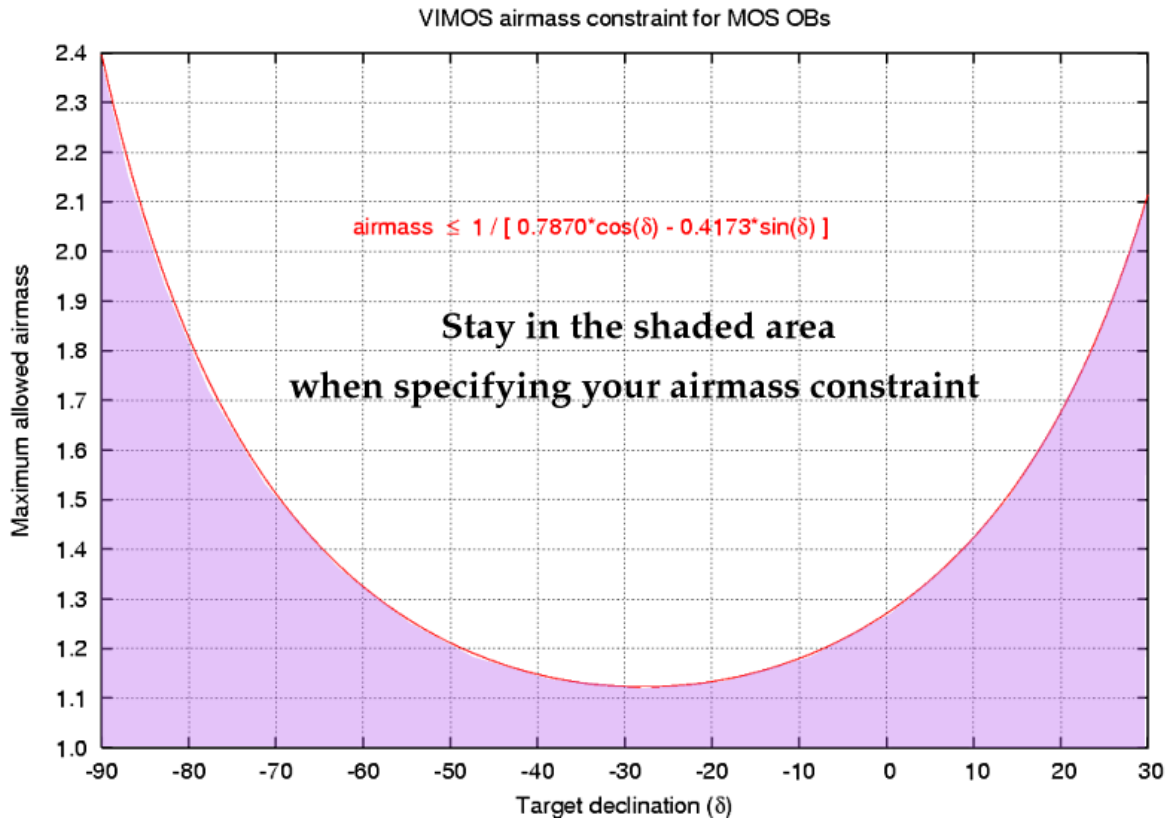

Figure 19: VIMOS airmass constraints.

2.4.3 Remnants

Long DITs (≥ 1800 s) in the NIR arm leave significant remnants in the K band from the thermal background and from the strongest sky emission lines. These remnants affect the nighttime observations and may still be visible in the morning dark calibrations. Therefore, DIT = 1800 s is only offered in visitor mode and under strong constraints in service mode:

- In combination with the K-band blocking filter (slits 0.6x11JH or 0.9x11JH) there are no remnants from the thermal background.
- The scientific gain must be significant and has to be justified (waiver request).
- The spectral format is fixed and thus remnants from the sky lines should not affect too much the observations. The presence of remnants in the following calibration frames, especially in dark frames, need to be considered.

The use of long DITs is not advisable, because of strong remnants in the following observations and the morning calibrations, and because of the sky variations. Remnants due to the thermal background in the reddest order of the K-band have been occasionally observed also with shorter DITs.

Remnants have also been observed in all three arms after ThAr calibrations (arcs, 2d-maps, format-checks). We therefore discourage attached arc calibrations during the night. During daytime, care is taken in order to acquire arc exposures without affecting other calibration data. The UVB detector does not show remnants after arc exposures of 6 to 300 s with 1x1 binning, normal readout mode, 3 s exposure in the 1x2 binning for the normal readout mode, and 1 s exposure for the 2x2 binning in the normal readout mode.

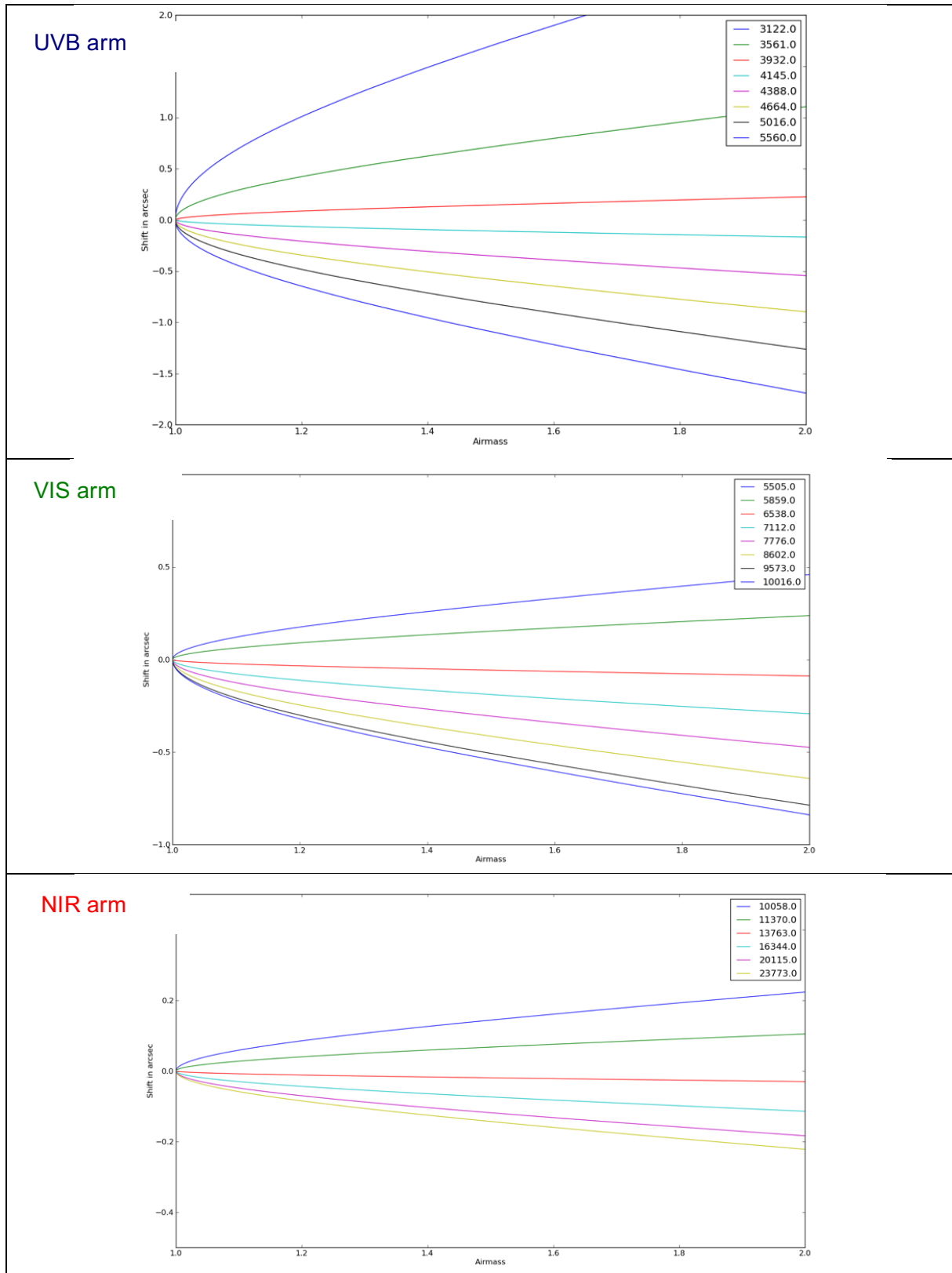

Figure 20: Atmospheric dispersion effect (in arcsec) for different wavelengths (in Angstrom) depending on the airmass.

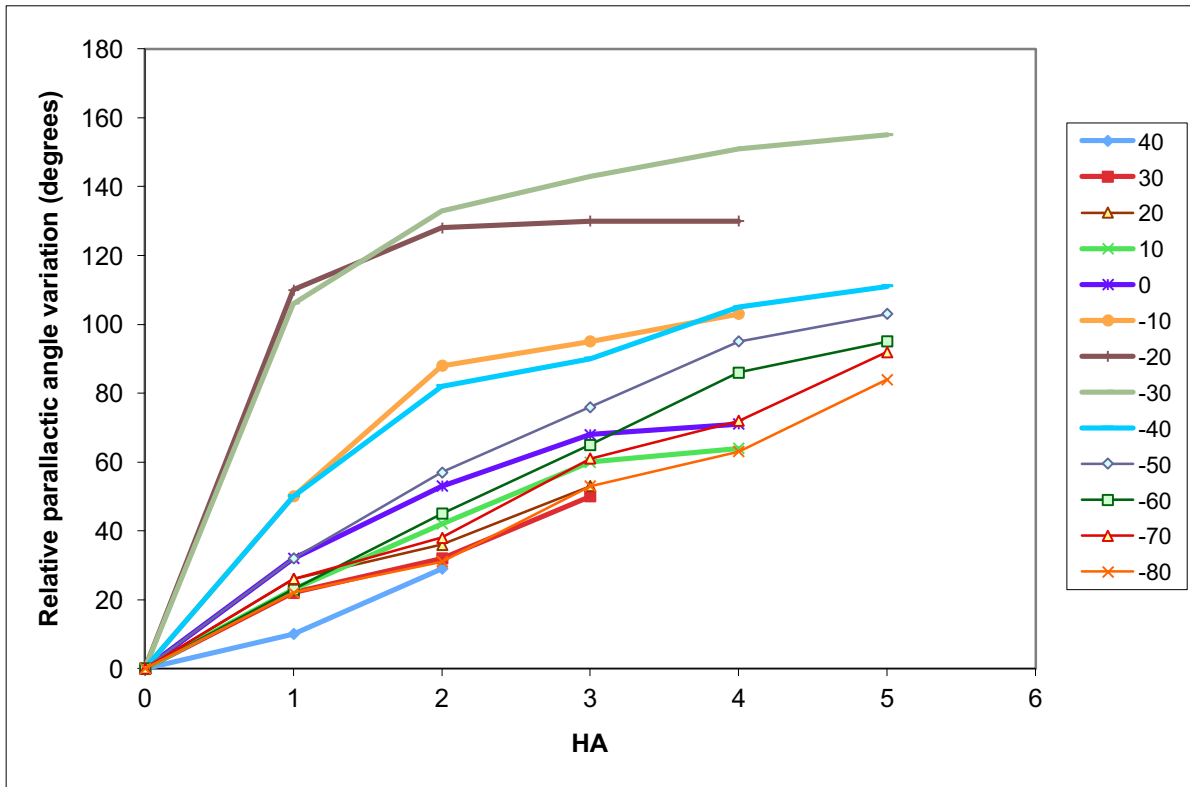

Figure 21: Relative parallactic angle variation with respect to hour angle for different declinations.

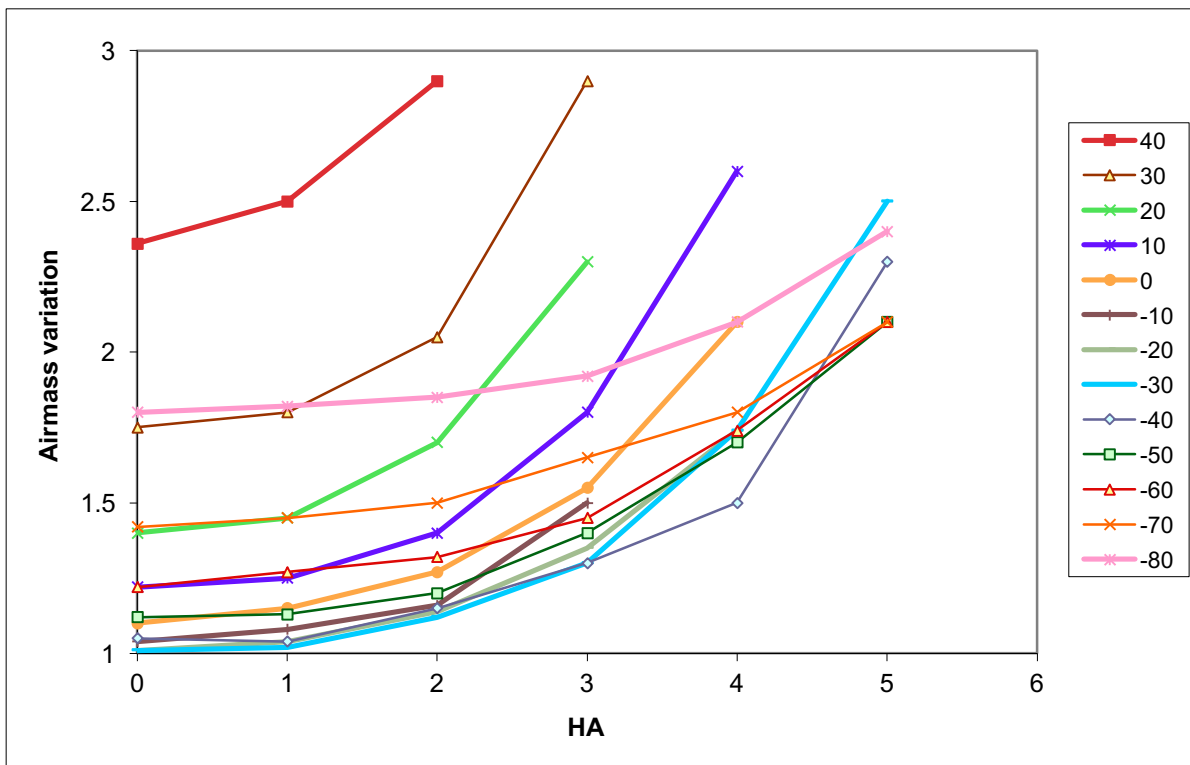

Figure 22: Airmass variation with respect to hour angle for different declinations.

2.4.4 Ghosts

Spurious reflections from the rear surfaces of the dichroics towards the first surface and back produce a secondary image of the object on the slit that is displaced from its parent by a few arcseconds and leads to almost in focus ghost spectra. For a centered object, the ghost is located at the edge of the orders. When a bright object is at the top part of the slit (positive x) it moves in. The ghost is strongest in the last order of the UVB spectrum in the wavelength range of the dichroic reflectivity cut-off (Figure 23). In the VIS, the ghost is noticeable in several orders and its intensity is $< 0.5\%$ of the parent spectrum (Figure 23). These ghosts are particularly relevant when observing bright objects with the SLIT nodding template.

A possible ghost seems to exist in the NIR arm when observing bright objects (Figure 24). It lies at the bottom-edge of some orders (at $\sim 5''$) and is less than 1% of the true spectral counts.

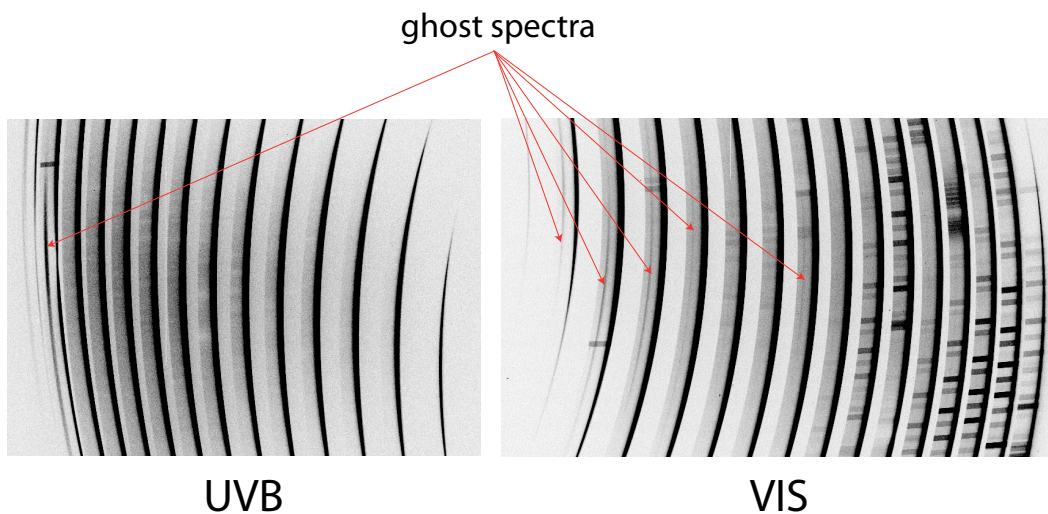

Figure 23: Ghost spectra in UVB and VIS produced by back reflection in the two dichroics.

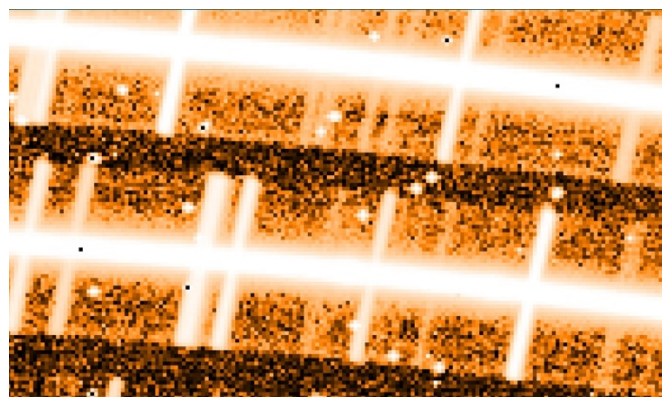

Figure 24: Ghost spectrum in the NIR arm.

2.4.5 Inter-order background

Inter-order background subtraction is a difficult task, in particular in the red part of the VIS arm where the order spacing is small (~ 4 unbinned pixels). Therefore, whenever a good inter-order background subtraction by the pipeline is important, we recommend not using the 2x2 binning mode for the VIS arm.

2.4.6 Features in NIR frames with the K-band blocking filter

Figure 25 indicates a light leak in the K-band blocking filter in the right top corner of the NIR frame. The counts are much lower than without the filter and, in any case, the corresponding order is not used for science when using these slits. With the 0.6" JH slit, some low level interferences are visible in the reddest part of the last order. They are due to the filter itself. In the worst case, the fringe peak-to-peak difference is 10% of the counts. The fringes appear stable and can be corrected with the flatfields.

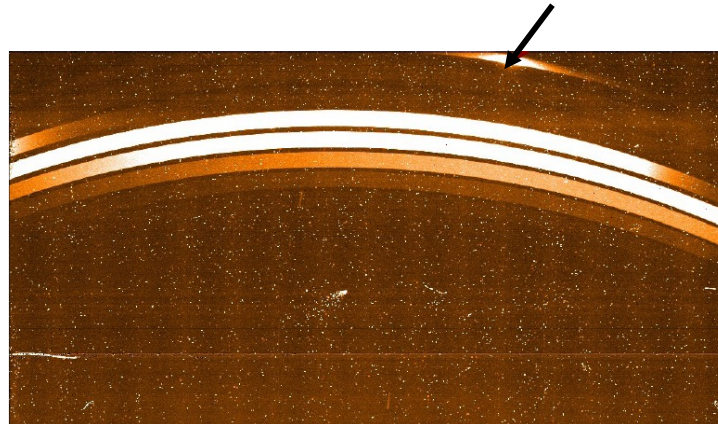

Figure 25: Leak in the K-band blocking filters.

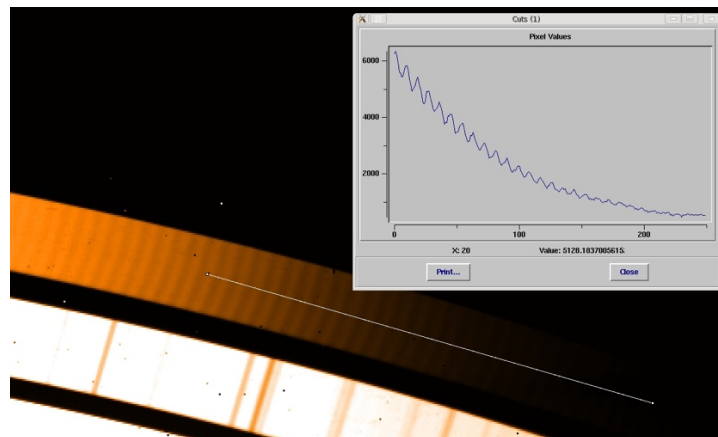

Figure 26: 0.6" JH slit, some low level interferences are visible in the reddest part of the last order.

2.4.7 NIR detector: inter-quadrant cross-talk and electrical ghosts

The X-shooter NIR detector, as most infrared detectors, suffers from an effect called inter-quadrant cross-talk. When part of the array is illuminated by a bright object, some other parts are "activated" as well, leading to an artificial signal. The following link explains in details the crosstalk effect: http://www.eso.org/~gfinger/hawaii_1Kx1K/crosstalk_rock/crosstalk.html

In addition to the cross-talk, the X-shooter detector (as all HAWAII detectors) suffers from electrical ghosts. The readout speed and a voltage parameter have been set to minimize these effects (without increasing the readout noise), but they can still appear sometimes:

http://www.eso.org/~gfinger/marseille_08/AS08-AS12-9_H2RG_mosaic_gfi_final.pdf

Both features give artificial signals with a count level close to the sky background level. They are mostly noticeable in observations with the K-band blocking filter.

2.4.8 Instrument stability (backbone and spectrograph flexures)

The active flexure compensation (AFC) allows to maintain the three slits aligned with respect to the reference A&G pinhole to within $\sim 0.02''$ at any rotation angle for $ZD < 60^\circ$. It is advised to run the AFC procedure once every hour (it takes 70-80 s) to correct for the effect of a varying gravity vector and drifts of the piezo mirror position related to the control electronics of these devices. It is advised to not skip the AFC when starting a new observation. From 0° to 60° zenithal distance the spectral format in all three arms stays within ~ 1.2 pixels from the zenith position for any rotator angle.

2.4.9 Radial velocity accuracy

The systematic wavelength calibration accuracy using the X-shooter pipeline and the arc 2dmap calibration frames is:

- UVB: 0.03 nm (20 km/s at 450 nm)
- VIS: 0.02 nm (7.5 km/s at 800 nm)
- NIR: 0.004 nm (0.6 km/s at $2 \mu\text{m}$)

2.4.10 NIR 11th order vignetting

The flux in the 11th order (K band) decreases towards the top of the order by a factor of $\sim 10\%$. This is due to a bad design of the mask located in front of the NIR array. The same effect is present in the blue part of the 10th order. To correct this vignetting would imply a major intervention on the NIR arm with possible risks to degrade the NIR performance.

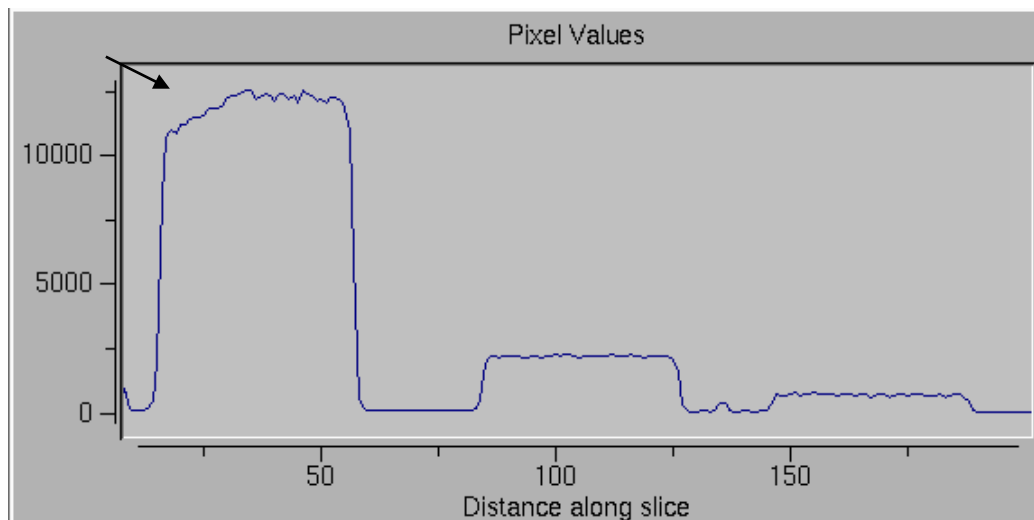

Figure 27: NIR11th order vignetting leading to a flux decrease (arrow). (Figure from L. Christensen.)

2.4.11 VIS CCD pick-up noise

The pick-up noise in the VIS detector is present in every readout mode (with a deviation from the background level of less than 0.5%). In case you want to observe faint targets with long exposure times, it is not recommended to use the fast readout mode due to the readout noise. In addition, the fast readout mode of the VIS CCD shows very low level patterns with a deviation from the background level of 1%. In the slow readout mode, the pick-up noise is lower and the patterns are not seen. Figures are available at:

http://www.eso.org/observing/dfo/quality/XSHOOTER/qc/problems/problems_xshooter.html

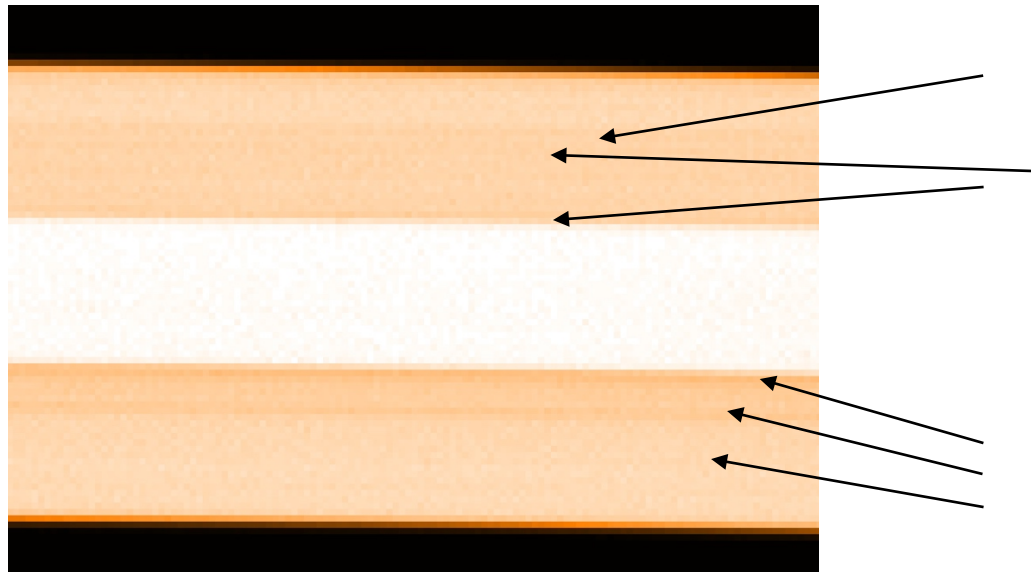

Figure 28: Example of small irregularities of the edges of the IFU mirrors in the NIR arm.

2.4.12 NIR IFU parasitic reflections

In IFU mode, some reflections of small irregularities of the edges of the IFU mirrors can be observed in the images (Figure 28). They are faint and should not affect the observations.

2.4.13 Drift of acquisition reference positions

Acquisitions with X-shooter are performed blindly (it not possible to see the slits directly). The reference positions for the acquisitions are defined for all filters. However, a function is slowly moving with temperature changes, which leads to a drift of these reference positions. This is now monitored and rectified when the drift reaches a significant amount. Unfortunately, a bad software update led to a bad centering of the targets on the slits and may have generated losses during the period between December 2013 and June 2014 for observations using narrow slits and the U-band and g_prime acquisition filters. There are small residuals in the radial velocity depending on the position in the slit (which still need to be fully characterized but they appear much smaller than the offsets that was due to the pipeline issue).

2.4.14 Wavelength shift between arms

A shift in wavelength between the arms, especially between the VIS and NIR arms, is related to two issues. The first one was the drift of the acquisition reference positions (Section 2.4.13). The second one was due to an error in the AFC recipe of the pipeline. Both problems were corrected (pipeline version 2.6.8 released on 2015-09-14) and the remaining errors are now consistent with the radial velocity accuracy:

https://www.eso.org/sci/facilities/paranal/instruments/xshooter/doc/XS_wlc_shift_150615.pdf

2.4.15 A&G TCCD features

The cooling system of the TCCD produces small oscillations of the temperature of the TCCD. Temperature variations affect the dark current level. In case of short exposure times, when the image sampling frequency happens to align with the frequency of the temperature oscillations, this leads to "beats" and background level variations from one image to the next. These variations in the background disappear for longer exposure times. They do not affect the acquisition performance. In June 2011, the noise was improved and the quality of images allow



Doc: VLT-MAN-ESO-14650-4942
Issue P102v2
Date 02.06.2018
Page 41 of 96

under good weather conditions to acquire objects as faint as magnitudes 25 in V band with a 3 min integration time.

Since an upgrade of the VLT software driving all acquisition CCDs in January 2014, the snapshots saved during the acquisition process were of sub-optimal quality until mid-2016.



3 Observing with X-shooter

X-shooter offers three observing modes: SLT spectroscopy, IFU spectroscopy, and IMAGING. The spectral format is fixed for both spectroscopic observing modes. The three arms (UVB, VIS, and NIR) operate in parallel. All X-shooter science observing blocks (OB) are composed of an acquisition template followed by one or several science templates.

In SLT mode, the user can select, for each arm independently, a slit width among those listed in Table 11. In IFU mode, the only important parameter the user can choose is the wavelength that is kept fixed at the center of the IFU during observations. Section 2.4.2 describes the effects of this wavelength choice on the spectral flux. In both spectroscopic observing modes, the detector readout can be selected for the UVB and the VIS arm independently. The readout is fixed for the NIR arm.

In IMAGING mode, the A&G camera is used with a set of Johnson and SDSS filters. In service mode, this mode has to be combined with SLT or IFU observations. The calibration plan is limited, because X-shooter remains foremost a set of spectrographs.

The offsets in all templates are offsets on sky. They are computed as follows: the 'offset RA' corresponds to $\Delta(\text{RA}) \cdot \cos(\text{DEC})$ and the 'offset DEC' is the difference $\Delta(\text{DEC})$.

3.1 Target acquisition

3.1.1 The acquisition loop

The target acquisition for SLT and IFU modes is almost identical. The main steps of a typical acquisition sequence are the following:

1. Warmup of the lamp for the flexure correction measurement.
2. Preset the telescope to the target coordinates and set the adaptor-rotator to the chosen position angle.
3. UVB and VIS ADCs start tracking to compensate for atmospheric dispersion in SLIT mode or set to their OFF position (i.e., at minimum deviation) in IFU mode.
4. Cross-correlating two frames of arc lamp spectra measures the backbone flexure. The first frame is an arc lamp spectrum taken with the A&G slide's 0.5" pinhole and with the 5" slit in each arm. The second frame is an arc spectrum taken with the 0.5" pinhole present in each slit slide/arm and the slot position in the A&G camera. Commands are sent to the three tip-tilt mirrors based on computed flexures. If necessary, this process is re-iterated.
5. The A&G slide is set to MIR position: the field is now visible in the acquisition camera and an acquisition image can be acquired.
6. The spectroscopic target is identified (or the reference object in case of blind offset) and its coordinates on the detector are determined by a centering algorithm.
7. The telescope is offset to the reference pixel on the detector corresponding to the position of the image the A&G slide's reference pinhole corrected in real time for effects of atmospheric refraction between the wavelength of the selected acquisition filter and the telescope tracking wavelength (470 nm for SLT mode, user selected for IFU mode).
8. Loop over steps 5 and 6.
9. When the observer is satisfied with the object centering, an acquisition image is saved and the A&G slide is either set to the spectroscopic observations position (10"x15" slot) in SLT mode or to the IFU position along with other mode specific instrument setup.



10. Alternative to step 8, in case of a blind offset, the offsets are applied before acquiring the final image and moving to the spectroscopic observation position.
11. At this point, the instrument is ready for science observations.

This acquisition sequence is performed by the two acquisition templates (XSHOOTER_slit_acq and XSHOOTER_ifu_acq). The instrument setup is done within the acquisition template so that for instance an IFU observation can never follow a SLT acquisition sequence and vice versa.

At the end of the acquisition sequence, an acquisition image is saved, and, in case of a blind offset, another image is saved after the offset. FITS header keywords HIERARCH ESO SEQ AG XCEN and YCEN record the location of the center of the SLT or IFU in the image.

3.1.2 Blind offset precision

For targets fainter than V~22 mag target acquisition needs to be performed with a blind offset from a reference star. For a blind offset acquisition, the coordinates of the reference target need to be given in the target field in the OB (and not the coordinates of the target itself). This reference target is then centered on the slit/IFU during the acquisition. The offset to the science target is specified in the acquisition template as 'Offset RA' and 'Offset DEC'. These offsets are given in arcsec, and denote offsets on sky. This means that, e.g., an offset of 'offset RA = 10.5' and 'offset DEC = -5.0' will move the slit to a target that is 10.5" east and 5.0" south of the reference target. The 'Offset RA' corresponds to $\Delta RA \cdot \cos(DEC)$, and the 'Offset DEC' is the difference ΔDEC . Both the reference target as well as the science target must be clearly indicated on the finding chart. It is important to take the proper motions of the objects into account.

The accuracy of the blind offset is better than a few mas. If the offset is very large (larger than the fov of the Cassegrain focus of a few arcmins), then the telescope operator may have to choose another VLT guide star which will introduce an offset in the coordinates and positioning (depending on the quality of the guide star coordinates). The VLT guide star in the acquisition template should not be confused with the reference star for the blind offset.

3.2 Observing modes

X-shooter science templates support different observing strategies: staring (commonly used for ultraviolet and visible observations), nodding along the slit (classical near-infrared observations), offsetting to a fixed sky position (for extended objects), or any sequence of offsets (mapping). Due to the small field of view of the IFU, we recommend to offset to a sky position in case good sky subtraction is needed. See the [Characterization of the X-shooter IFU mode](#) report for a characterization and some recommendations regarding X-shooter IFU observations and data analysis.

3.2.1 Staring (SLT and IFU)

With the XSHOOTER_slit_obs_Stare and XSHOOTER_ifu_obs_Stare templates, spectra are taken in each arm independently at a fixed position on sky. For each arm, the user chooses the exposure time and the number of exposures. Exposures are completely asynchronous, i.e., in each arm whenever an exposure is finished and read-out the next one starts immediately, independently of the other arms.

3.2.2 Staring synchronized (SLT and IFU)

Synchronized exposures can be obtained with the XSHOOTER_slit_obs_StareSynchro and XSHOOTER_ifu_obs_StareSynchro templates. In this case, the number of exposures is fixed to one per arm. Exposure times can be different for each arm, but are synchronized to their mid-time. In case the exposure times in all three arms are identical, exposures in the three arms will have the same start time within approximately one second. In the case of different exposure times, the mid-exposure time of the three will coincide within about one second.

3.2.3 Nodding along the slit (SLT)

Nodding is the standard way of observing in the near-IR, primarily aimed at a double pass sky subtraction. The template XSHOOTER_slit_obs_AutoNodOnSlit nods the telescope between two positions (A and B) along the slit. The user defines a *nod throw* and optionally a small *jitter box* (along the slit direction). The *nod throw* is defined as the distance between the two nodding position, i.e., the center of the two *jitter boxes* inside the slit (Figure 29). The jitter value corresponds to the size of the box. One cycle is a pair of AB or BA observations. Cycles are repeated in ABBA sequences. For each arm, the user chooses the number of exposures at each position and the exposure time (both identical for all A and B positions). Exposures are asynchronous. Nodding is not offered in IFU mode because the field of view (4"x1.8") is too small to nod within the IFU. It is not possible to move the target in one arm independently from the other arms.

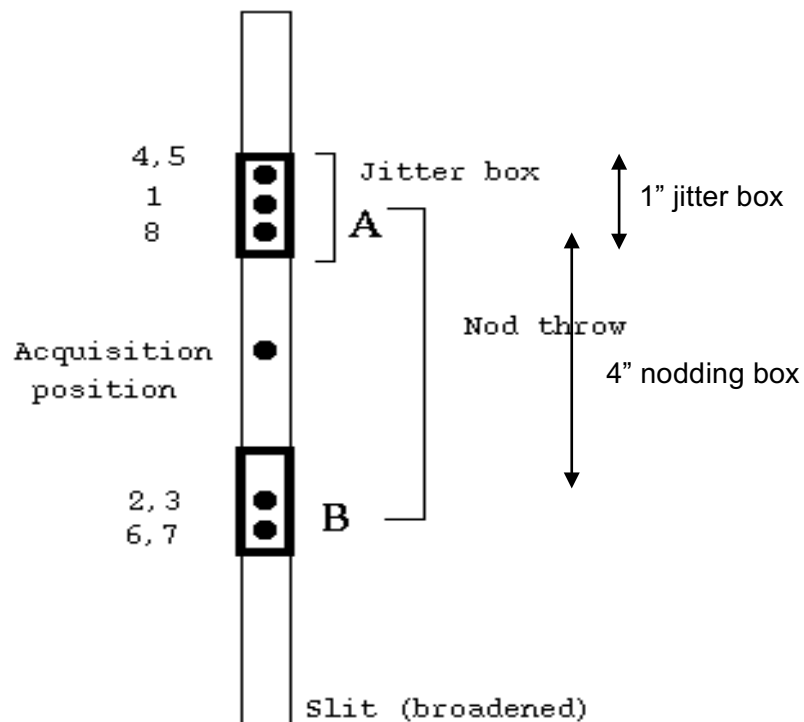

Figure 29: Conventions used for a nodding of 4" along the slit. The sequence illustrated here corresponds to 4 cycles (8 exposures, ABBAABBA) with a jitter box of 1".



3.2.4 Fixed offset to sky (SLT and IFU)

When observing extended objects for which there is no or not enough sky inside the 11" slit to perform a good sky subtraction, the templates XSHOOTER_slit_obs_FixedSkyOffset or XSHOOTER_ifu_obs_FixedSkyOffset can be used. They allow alternating between an object (O) and a sky position (S) with the possibility of adding a small jittering around the object and the sky position. One cycle is a pair of OS or SO observations. Cycles are repeated in OSSO sequences. For each arm, the user chooses the number of exposures taken at each position and the exposure time (both identical for all O and S positions). Exposures are asynchronous.

3.2.5 Generic offset (SLT and IFU)

These are the most flexible observing templates. XSHOOTER_slit_obs_GenericOffset and XSHOOTER_ifu_obs_GenericOffset allow the user to define any pattern by providing a list of (cumulative) telescope offsets. This is particularly useful in case one wants to map an object with several positions. The offsets in all templates are offsets on sky. The number of exposures taken at each position and the exposure time (both identical at all positions) have to be defined. Exposures are asynchronous. The number of sky and object positions must be the same. This is also the case for the exposure times.

3.2.6 Mapping (SLT and IFU)

Mapping templates in SLT and IFU modes allow the user to define any pattern by providing a list of (cumulative) telescope offsets. This is particularly useful for mapping an object with several positions. The number of exposures taken at each position and the exposure time has to be defined. Exposures are asynchronous. These templates allow for different numbers of sky and object positions.

3.2.7 Imaging

A simple imaging mode with limited functionalities is offered to the community. The imaging mode uses the A&G camera and its set of Johnson and SDSS filters. Acquisition images can be used to flux calibrate spectra in addition to the usual spectrophotometric observations. Other applications are the determination of magnitudes of transient objects such as GRB counterparts, supernovae, and variable objects. No pipeline support is provided for the imaging data, but for the detector linearity determination.

In order to ensure a proper background in the exposures (due to the Peltier cooling of the TCCD), the user is recommended to take at least three exposures per filter. By default, for direct target acquisition one snapshot in the acquisition filter will be saved once the acquisition process is finished. For blind offset acquisition, one snapshot will be saved at the end of the acquisition of the reference star and one after the blind offset.

3.2.7.1 Detector characteristics, filters, and zeropoints

The A&G unit consists of:

- A Pelletier cooled, 13 μm pixel, 512x512 E2V broad band coated Technical CCD57-10 onto which the focal plane is re-imaged at f/1.91 through a focal reducer. This setup provides a plate scale of 0.1766"/pix and a field of view of 1.47'x1.47'.
- A filter wheel equipped with a full UBVRI Johnson filter set and a full Sloan Digital Sky Survey (SDSS) filter set.

The A&G TCCD cooling system produces small oscillations of the detector temperature, which affect the dark current level. In the case of short exposure times, when the image sampling frequency corresponds to the frequency of the temperature oscillations, this leads to "beats"

and background level variations from one image to the next. These variations disappear for longer exposure times.

The detector is cooled by a Pelletier and it takes time to evacuate the heating towards the cooling pipes that cool down the Pelletier itself. As a consequence, every time the integration time is modified, the first exposures has a higher background and noise. It is therefore recommended to take a series of two to three images per position/filter/exposure time. Figure 31 illustrates the effect of the Pelletier cooling delay.

The A&G TCCD zeropoints were determined for the Johnson filters under photometric condition (Table 14). Their accuracy is about 0.05-0.1 mag, depending on the filter.

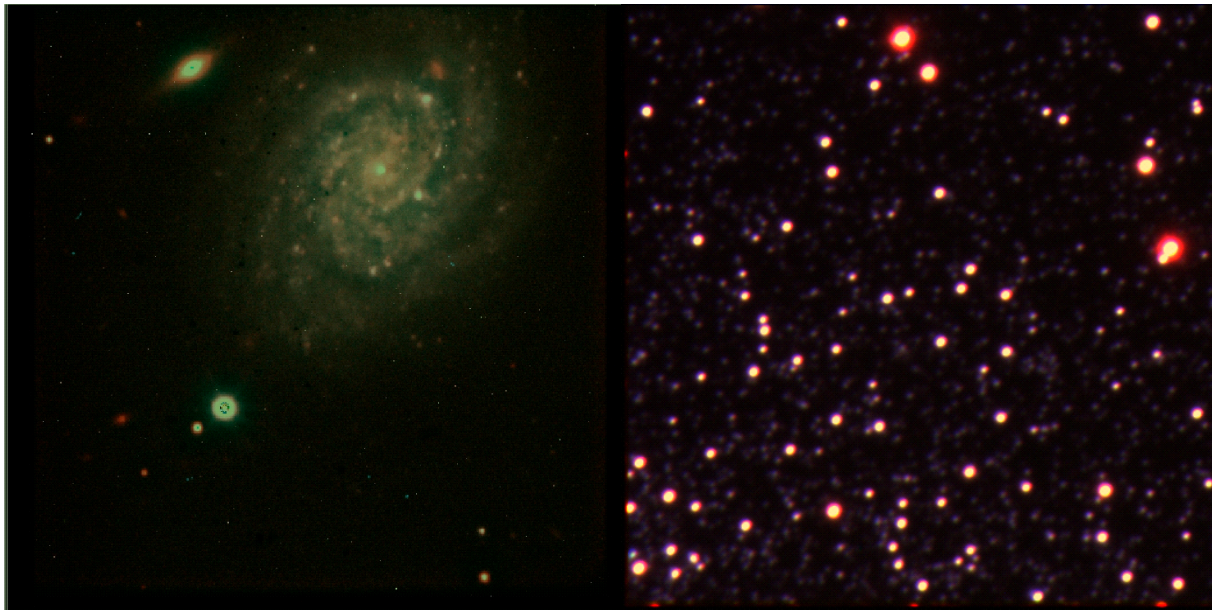

Figure 30: Three color (BVI) image of a galaxy with a supernova (left) and of a small field of 47Tuc (right).

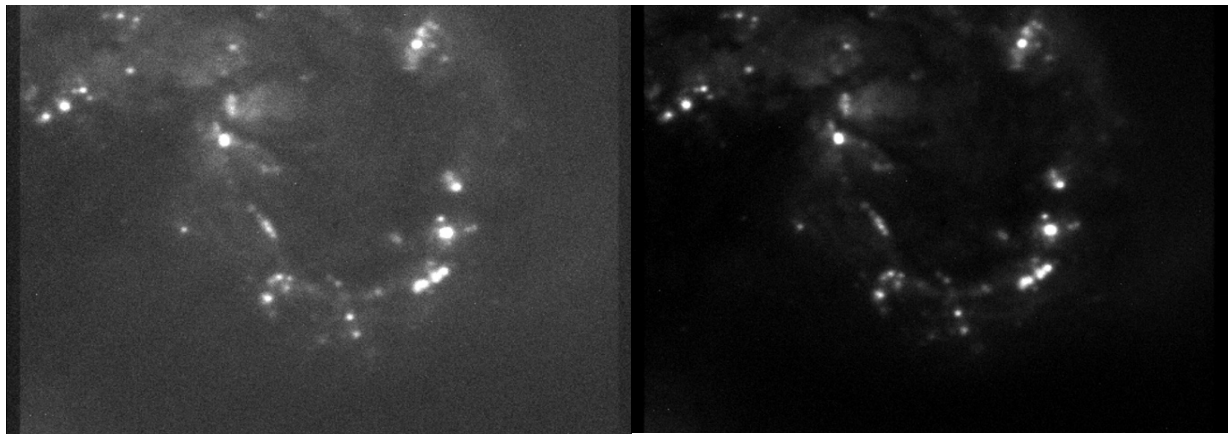

Figure 31: Antenna galaxy, B filter, 5 s exposure time. Left: First exposure of a series. The background is at 1800 ADUs and the RMS at 12 ADUs. Right: Second exposure of a series. The background is now at 1711 ADUs and the RMS at 6.5 ADUs.



Table 13: A&G TCCD characteristics.

Detector type	E2V CCD57-10IE
Cooling system	Pelletier
QE	82% at 580 nm, 50% at 380 nm and 820 nm
Number of pixels	562x528
Pixel size	13 μm x 13 μm
Pixel scale ("/pixel)	0.1766 +/- 0.0004
Field of view	1.5'x1.5' (but filters do not cover the corners)
Gain (e⁻/ADU)	1.29 \pm 0.02
Readout noise (e⁻ rms)	4.14 \pm 0.08
Saturation (ADU)	65535
Readout mode and overheads	Fast readout mode only. Wipe time: 0.01 s, readout time: 0.33 s, transfer time: 0.78 s, total time: 1.12 s.
Dark current level (ADU/pixel/h)	0.97 (exposure time of 10 s)
Fringing amplitude	Depends on the filters. 2% to 4% in l, z'
Non-linearity (ADU)	< 1% at 10000 ADUs and 50000 ADUs
Bias level (ADU)	1688 \pm 5.5
Prescan and overscan areas	X: 1-26 and 538-562 Y: 1-15 and 528

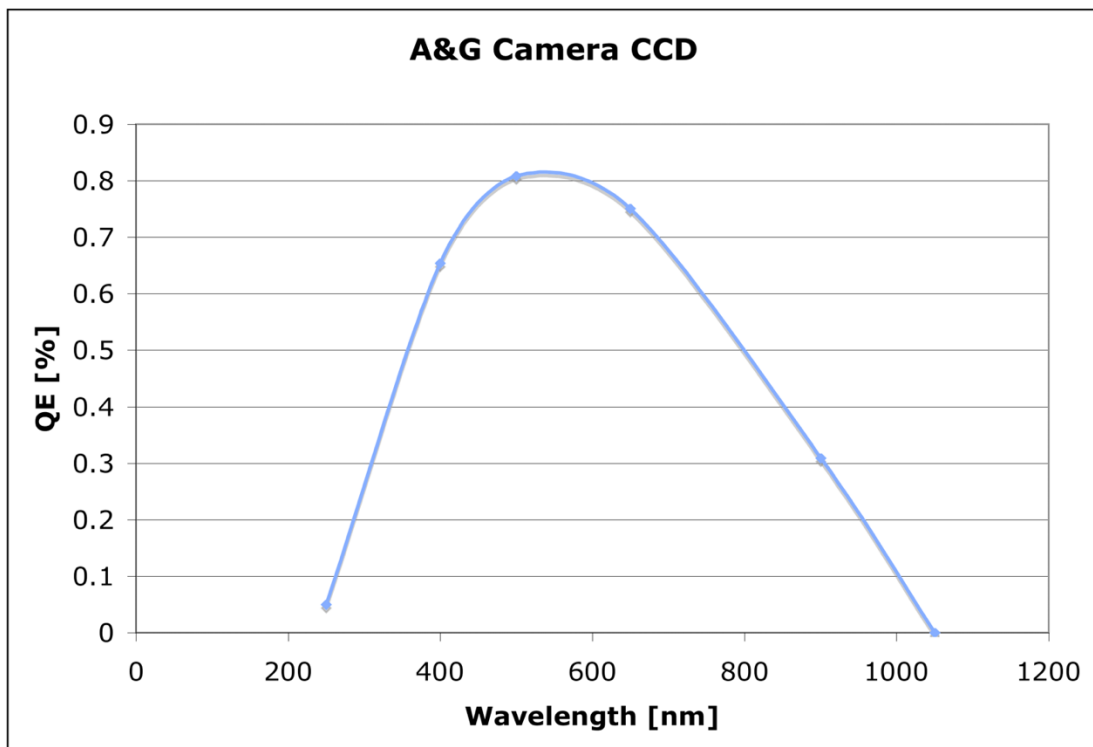

Figure 32: A&G TCCD quantum efficiency curve.

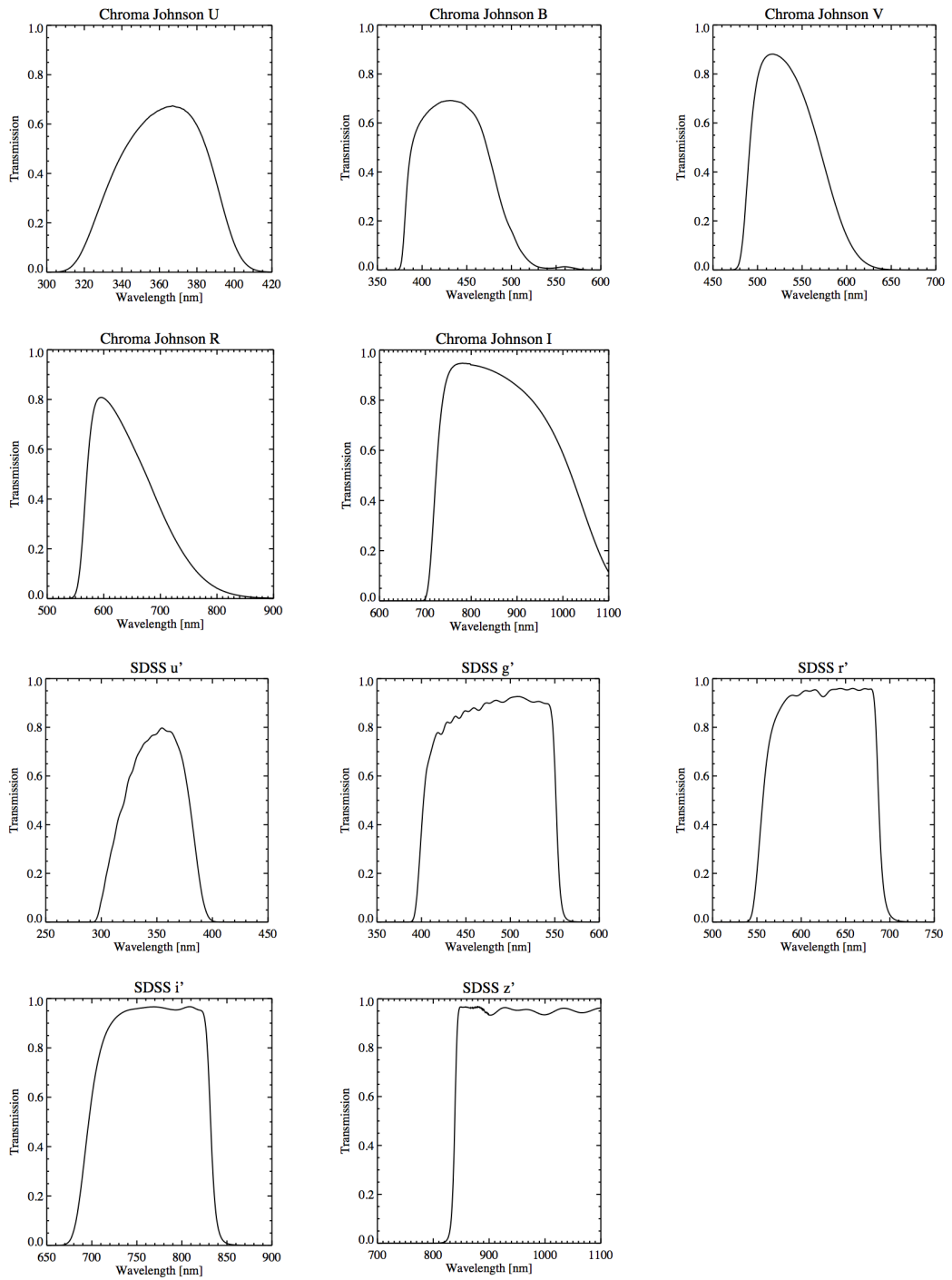

Figure 33: A&G camera filter curves.

Table 14: A&G TCCD zeropoints. FORS2 zeropoints are provided for reference.

	U (mag)	B (mag)	V (mag)	R (mag)	I (mag)
ZP X-shooter (10/2014) at UT2	24.94	27.27	27.20	27.13	26.73
ZP X-shooter (11/2013) at UT3	24.83	27.91	27.83	27.74	27.36
ZP X-shooter (07/2011) at UT2	24.95	27.74	27.63	27.83	27.49
ZP FORS2 (2011)	24.31	27.68	28.09	28.32	27.67

3.2.7.2 Stability of the A&G TCCD

To investigate the stability of the A&G TCCD for photometry, the spectrophotometric standard star GD71 was monitored over 1 hour with exposures every few seconds. The 1-sigma standard deviation in B and V bands are 0.006 mag for both bands, which represents a variation of 0.4%. The medium term stability was analysed based on the evolution of the bias and readout noise levels (Figure 34). Over a period of 52 days, the RMS of the bias level variability is 0.33% and for the RON 0.56%. The long term stability of the instrument was tested with the spectrophotometric standard star EG274 observed during a period of more than 500 days. The star was often observed under sub-optimal condition (e.g., twilight with fast variable sky background). Nevertheless, the RMS is of 0.42%. The noise structure/background follows the ambient temperature evolution. The Peltier that cools down the detector is cooled down with a coolant flow. Unfortunately, if there is an ambient temperature increase or if the temperature is high, the Peltier is not cooled down fast enough and the background/noise structure is higher. Despite this, the detector remains the best acquisition detector at Paranal.

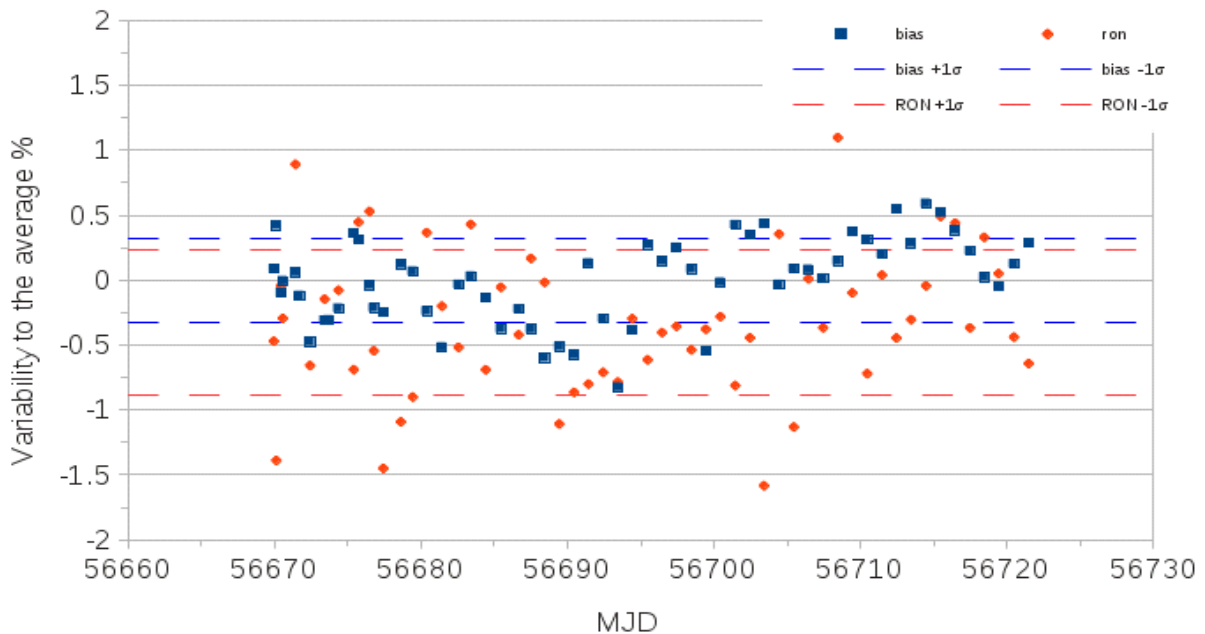

Figure 34: Stability of the A&G TCCD. Evolution of the bias and readout noise levels.

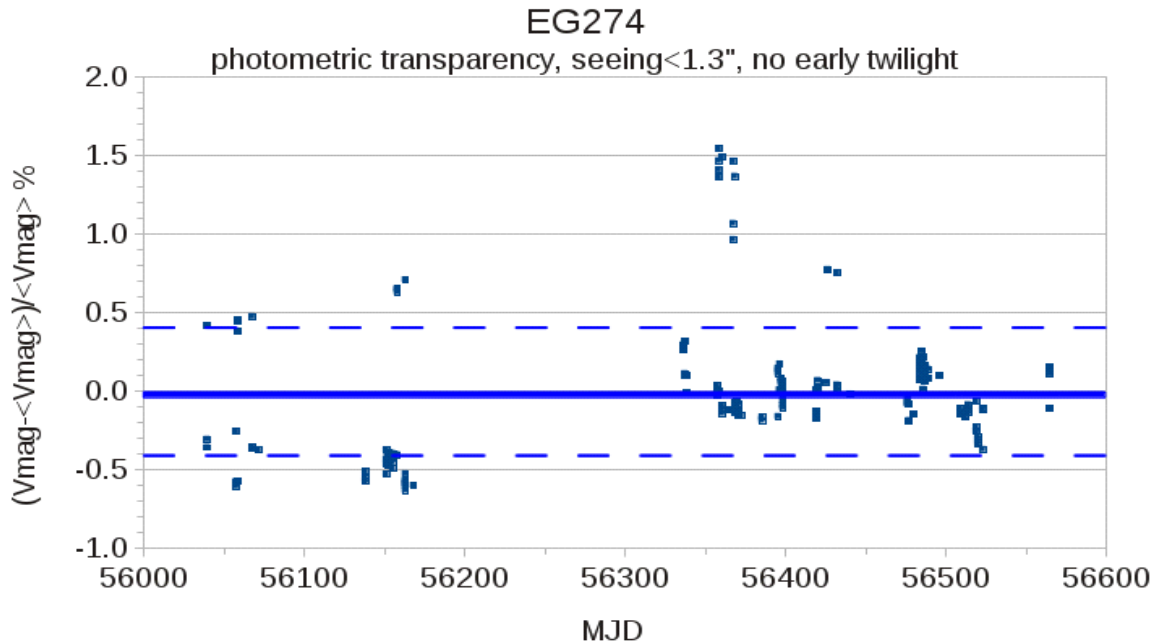

Figure 35: Photometric transparency.

3.2.7.3 Calibration plan and observing strategies

A basic imaging observing block (OB) consists of a SLT or IFU acquisition template, followed by science and/or calibration and IMAGING templates. Pure imaging OBs, i.e., without spectroscopic templates, are approved only in visitor mode. Exceptions in service mode are observations of standard fields for zeropoint determination or distortion maps. There is no ETC support for the imaging mode. We recommend to scale the exposures times using the limiting magnitudes listed in Table 15.

Table 15: Recommended exposure times for the A&G TCCD (S/N > 5).

V (mag)	6	7	16-20	23	≥24
Exposure time (s)	0.001	0.005	1-5	60-120	≥180

Two science imaging templates are offered:

XSHOOTER_img_obs: STARE observation (object stays on the same detector pixel)

XSHOOTER_img_obs_GenericOffset: GENERIC-OFFSET observations (mapping or jittering around the area of interest)

It is recommended to use the XSHOOTER_img_obs_GenericOffset template in order to better correct for the sky background and the dust spots on the detector. One can define a sequence of small offsets. The reference system can be chosen to be the sky (Alpha, Delta) or the X-shooter detector coordinate system (X, Y). Templates use cumulative offsets. For example, the series of offsets: 0, -10, 0, 10 brings the telescope back to the original position for the last exposure.

The calibration plan is defined in Table 16.

Table 16: Imaging mode calibration plan.

Type of calibration	Template	Frequency
Day: bias	XSHOOTER_img_cal_Dark	10, daily
Day: dark	XSHOOTER_img_cal_Dark	on request, 3x10s monthly
Day: linearity	XSHOOTER_img_cal_DetLin	monthly
Night: twilight flats	XSHOOTER_img_cal_Flat	10, monthly*
Night: zeropoints	XSHOOTER_img_obs_cal_phot	once per year or user provided
Night: distortion map	XSHOOTER_img_obs_cal_dist	once per year or user provided

*The count levels of the twilight flats should be between 10000 and 55000 ADUs.

Some health check plots of the A&G TCCD (bias level, readout noise, noise structure, dark current, linearity, gain) are available at:

http://www.eso.org/observing/dfq/quality/XSHOOTER/reports/HEALTH/trend_report_BIAS_A_GC_HC.html

3.2.7.4 Distortion map, fringes, and astrometric accuracy

Figure 36 shows the distortion maps of the A&G TCCD with respect to 2MASS astrometry.

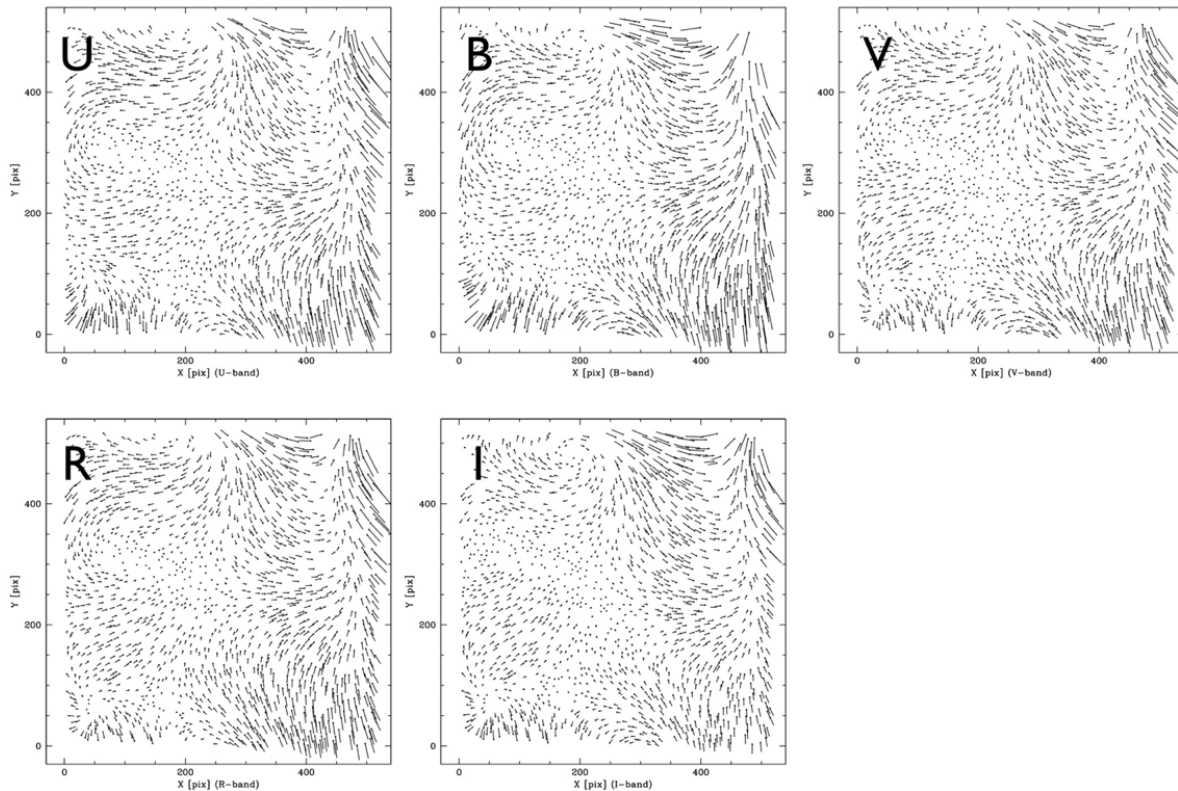

Figure 36: UBVRI distortion maps magnified x20.

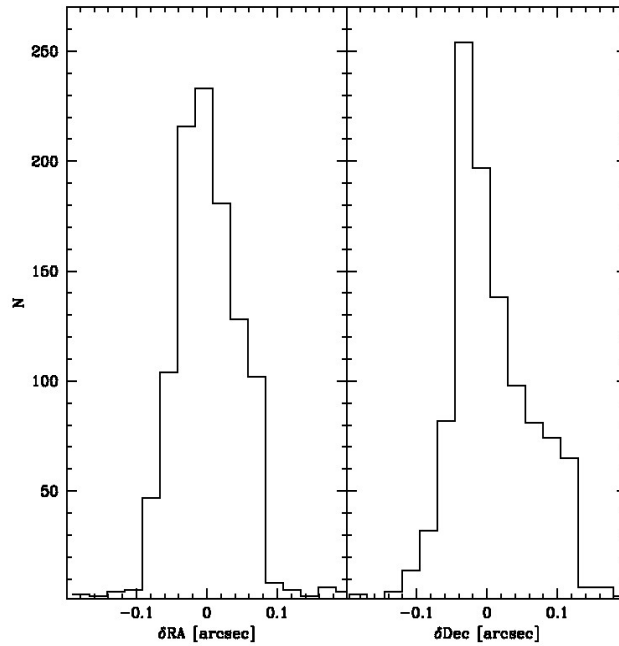

Figure 37: Distributions in RA and DEC of the difference between 2MASS and the AGCCD astrometry. The difference between 2MASS and the A&G TCCD astrometry is $\pm 0.1''$.

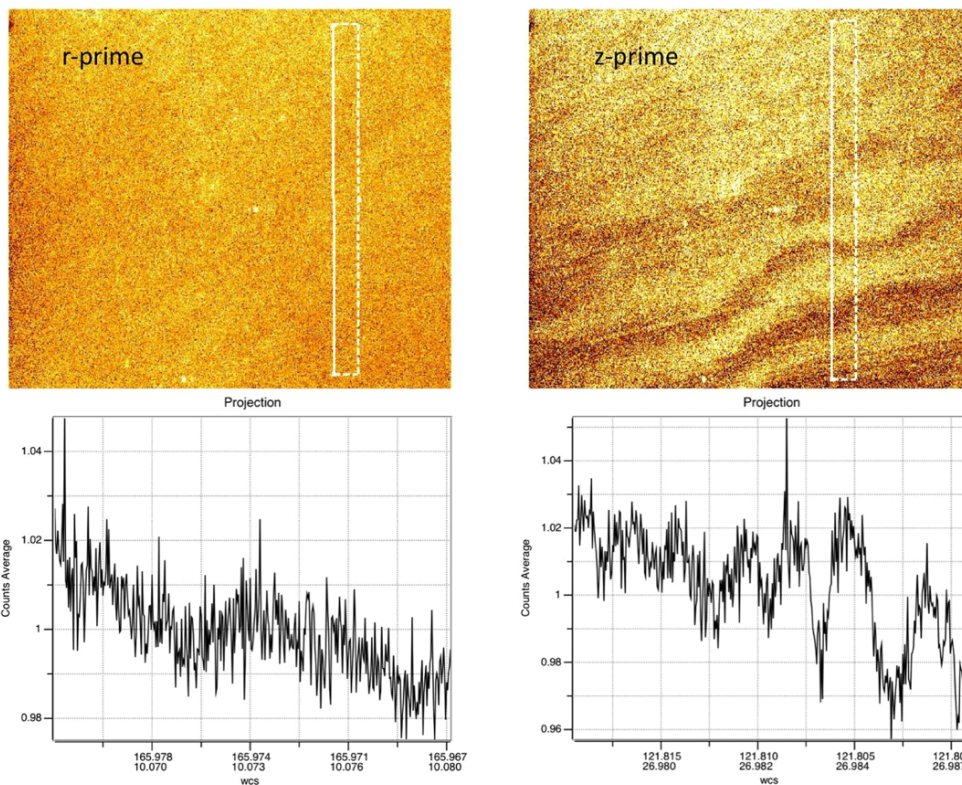

Figure 38: Fringing maps in r_prime and z_prime obtained from skyflats. The cuts in the bottom show the amplitude peak to peak of the fringes. The most affected filters are the r_prime , i_prime , z_prime , l . The peak-to-peak amplitudes range from 2% in the r_prime to 4% in the z_prime filter.



3.3 Observation strategies

3.3.1 Instrument setup

Table 17: Instrument setup summary.

Instrument mode	Observing mode	Readout/binning	Slits/filters	PA
SLT	STARE	UVB 100k,1x1 UVB 100k,1x2	UVB, 0.5",0.8",1.0",1.3",1.6",5" VIS 0.4",0.7",0.9",1.2",1.5",5" NIR 0.4",0.6",0.9",1.2",5", blind, 0.6"JH, 0.9"JH	9999=parallactic angle or choose another value
	NODDING	UVB 100k,2x2 UVB 400k,1x1		
	FIXED-OFFSET	UVB 400k,1x2 UVB 400k,2x2		
	GENERIC OFFSET	VIS 100k,1x1 VIS 100k,1x2		
	SYNCHRONIZED	VIS 100k,2x2 VIS 400k,1x1		
	ETC	VIS 400k,1x2 VIS 400k,2x2 NIR non-dest		
IFU	STARE	UVB 100k,1x1 UVB 100k,1x2	IFU 1.0"x12.6" fixed in each arm	9999=parallactic angle or choose another value
	FIXED-OFFSET	UVB 100k,2x2 UVB 400k,1x1		
	GENERIC OFFSET	UVB 400k,1x2 UVB 400k,2x2		
	SYNCHRONIZED	VIS 100k,1x1 VIS 100k,1x2		
	ETC	VIS 100k,2x2 VIS 400k,1x1 VIS 400k,1x2 VIS 400k,2x2 NIR non-dest		
IMAGING	STARE	Fast, 1x1	UVBRI u',g',r',i',z'	9999=parallactic angle or choose another value
	GENERIC OFFSET			

3.3.2 Observation strategy

This section provides some basic information for preparing the observations. For remaining questions, please contact usd-help@eso.org (SM and VM), or discuss the observing strategy with the Paranal day/night astronomers (in VM).

It is possible to mix different science templates and different slit widths on the different arms within one OB. For example: SLT acquisition - SLT STARE - SLT NODDING. SLT and IFU templates cannot be used together within a single OB.

a) Point-source objects

For point source objects SLT spectroscopic observation is usually the best choice. If the infrared part of the spectrum is critical, NODDING mode will allow for a better correction of the sky emission lines and the sky variations. In case the NIR arm is not critical, the use of the STARE mode is OK, i.e., the object will stay in the same position of the slit. This mode corresponds to the usual observing mode with other optical instrument such as UVES.



Select a slit width of 0.9"-1.0" if you want to match the slit width with the median seeing at Paranal (which is around 0.8"). For a higher resolving power, select narrower slits. For accurate flux calibration, select the 5" slits.

It is possible to combine in the same OB different templates/observing modes. One can use the STARE mode with 5" slits for the flux calibration and in the following template the NODDING mode with narrower slits.

b) Point-source object with bad seeing: IFU as image slicer

The SLT mode is commonly used for the observation of point-source objects. However, in case of faint objects or under bad seeing conditions, IFU mode could be more appropriate, because this is physically an image-slicer. Nodding is not possible with IFU and for better sky correction an offset to a sky position (FIXED-OFFSET) is required. The IFU resolving power is fixed. The user has to specify the tracking wavelength since the ADCs are in OFF position. See the [Characterization of the X-shooter IFU mode](#) report for a characterization and some recommendations regarding X-shooter IFU observations and data analysis.

c) Extended objects or crowded fields

In case of extended objects or crowded fields (e.g., galaxies or globular clusters), the sky correction is difficult. NODDING mode cannot be used in this case, because the offsets are too small to reach a sky position. The FIXED-OFFSET or GENERIC-OFFSET observing modes are suitable in the case of extended objects. With both templates the number of exposures on sky and object must be the same. This is also the case for the exposure times. The MAPPING templates are not restricted with respect to the number of sky or object positions and exposure times. For STARE mode observations a correction of the sky lines is performed by the pipeline. With the X-shooter pipeline, you can select the region of spectrum-extraction and thus one can extract the object spectrum and, e.g., the nebula spectrum.

e) Time series of variable objects

To follow, e.g., spectroscopic binaries or transits, the SYNCHRONIZED mode is suitable. It matches the observations in the three arms at the middle of their exposures. The readout time should be chosen as small as possible, i.e., the 400kHz mode is preferred to the 100kHz mode. However, this depends on the target (timescale of the variation, faintness).

f) Highly time-critical objects

In case of objects that are only visible for a few minutes or a few hours, or show fast flux variations (e.g., gamma ray bursts or supernovae) the Rapid Response Mode (RRM) is appropriate. The RRM acquisition template should be used.

g) Imaging mode

Imaging observations can be useful in case of variable objects, such as gamma ray bursts.

3.3.3 Telluric standard stars and telluric lines correction

Starting with Period 101, the calibration plan does not include observations of telluric standard stars for each observation. Instead, users are encouraged to use the Molecfit tool, available at <http://www.eso.org/sci/software/pipelines/skytools/>. Molecfit can provide accurate telluric line corrections in most cases, provided that a spectral region of about 10 to 40 nm is mostly free of intrinsic spectral features, but is instead affected by telluric absorption lines of low or moderate optical depths caused by water vapor. The signal-to-noise ratio per pixel in this spectral range should be larger than 5 per Observing Block. In the VIS, suggested spectral



regions are 810 to 830 nm or 940 to 951 nm. In the NIR, suggested regions are 1300 to 1321 nm, 1745 to 1785 nm, but other regions are possible.

The Observatory will obtain one telluric for each instrument setting observed during the night. No constraints on airmass and time constraints will be imposed. This applies also to visitor mode observations. Users are encouraged to use Molecfit. The temperature and water vapour profiles from LHATPRO (as measured by the radiometer) allow Molecfit to generate synthetic atmospheric emission and absorption spectra that can be used to efficiently remove telluric features. One limitation is the capability to measure the FWHM of the line spread function, which might be a challenge for low S/N spectra.

Observations of a telluric standard star is recommended in some cases, such as if

(a) the VIS or NIR spectrum shows low flux in all regions affected by telluric water vapor lines of low or moderate optical depths, so that the signal-to-noise ratio per resolution element is not expected to be larger than 10 per OB in any of these regions;

(b) the whole VIS or NIR spectrum is affected by strong intrinsic absorption lines.

The execution time for the observation(s) of the telluric standard star (1 per Observing Block of the science target) must be included in the phase 1 proposal.

Users that require a telluric standard star are required to submit the corresponding calibration in concatenation with the science. The [Telluric Standard Star Catalogue Search Tool](#) can be used to find appropriate stars (the "Hipparcos/2MASS B stars single" catalogue contains a list of single, B-type, main-sequence stars, verified in previous X-shooter observations). Telluric standard stars should have at least about 10000 ADUs in the middle of the brightest orders of each arm (S/N ~ 50-100). The time will be charged to the program. The telluric standard star observations can be performed in NODDING and with the fast readout mode in the UVB/VIS arms, irrespective of the readout speed used for the science. The binning should match the science OB.

3.3.4 Effects of atmospheric dispersion

In SLT mode, effects of atmospheric dispersion are automatically corrected in the UVB and VIS arms by two ADCs. They are fully working up to airmass of 2. For larger airmasses the compensation is not perfect and above airmass 2.5 the compensation is rather bad.

In IFU mode, there is no correction for the atmospheric dispersion (the two ADCs come after the IFU in the light path and are set to their OFF position where they do not disperse light). The user has to choose which wavelength will be kept fixed at the center of the IFU during observations using the SEQ.IFU.WLGT parameter in the XSHOOTER_ifu_acq template. It is set to the middle of the atmospheric dispersion range (470 nm) by default. It is recommended to orient the IFU parallel to the parallactic angle when possible. At high airmass, the amplitude of the dispersion is larger than the 4" of the IFU field. We thus recommend to specify low airmass for the observations (smaller than 1.5).

3.3.5 Exposure times in the NIR arm

A limited choice of DIT values is allowed for the NIR observations in service mode to avoid endless daytime calibrations. There are no constraints for short NIR exposure times (up to 300 s). Only the following longer DITs are available: DIT = 300 s, 480 s, 600 s, 900 s, and 1200 s. DITs \geq 1800 s are not offered, because they leave remnants. The minimum DIT is 0.66 s.

The use of an NDIT different than 1 will give one internally averaged exposure of the DIT integrations. The pre-processor of the system is averaging internally the NDIT individual DIT



integrations. The number of counts will only correspond to DIT but the noise will be reduced. NDIR=1 should be used in most cases. Examples:

NDIT=2, DIT=100 s, NINT=1 gives one averaged exposure of 200 s.

NDIT=1, DIT=100 s, NINT=2 gives two exposures of 100 s each.

NDIT=2, DIT=100 s, NINT=2 will give two averaged exposures of 200 s each.

3.3.6 Readout times in the UVB and VIS arms: minimization of overheads

Because the UVB and VIS detectors are sharing the same FIERA controller, both detectors cannot be read out at the same time. Therefore, it may happen that one arm, although its exposure is already finished, has to wait the end of the read-out of the other arm. To minimize the dead-time, one can increase the exposure time in one of the arms in such a way that while the first image is being transferred, the other arm is still integrating. For example, for slow read out mode, unbinned, and photon starved in the UVB, one should make the VIS integration at least 89 s shorter than the UVB one (Table 18). The readout time of the NIR is very short ~1 s and does not interfere with the UVB and VIS because it is using a different controller (IRACE).

3.3.7 Observations of bright targets

Objects with magnitudes brighter than 3 to 4 mag will saturate the NIR detector. The minimum DIT in the infrared is 0.66 s. This means that the IRACE controller will transform DITs shorter than 0.66 s to 0.66 s integration. The minimum exposure time in the UVB and VIS is 0.1 s. For bright targets, reduce the exposure time as much as possible and choose the narrowest slit widths. Usually, the observations are conducted within the sky specification requested in the OB, i.e., with better conditions than requested in the OB. We encourage the users to check that the NIR counts do not enter the extrapolated regime of readout.

For observations of targets with magnitudes brighter than 4 mag, the virtual image slicer mode can be used (in VM only). By introducing a controlled amount of astigmatism in the VLT mirror control loop, the target light can be distributed (up to 6") along the X-shooter slits.

A *diaphragm mode* allows to observe very bright targets (magnitude -4). It is not yet decided whether this mode will be offered to the community. A report is available at:

<http://www.eso.org/sci/facilities/paranal/instruments/xshooter/news.html>

3.4 Instrument and telescope overheads

Within p2 it is possible to optimize the exposure times since the algorithm takes into account the time spent on the science exposures, the readout, the acquisition, and the instrument setups. UVB and VIS arms share the same FIERA controller, i.e., the readout of CCD1 will only take place once the readout of CCD2 is finished and vice versa. The readout of the NIR arm is independent.



Table 18: Overheads.

Acquisition and setup	
Telescope pointing, guide star acquisition, start active optics. X-shooter backbone flexure measurement.	360 s
Interactive acquisition loop	<p>Direct acquisition loop = + (Tel offset + AG_EXPOSURE)*3 + AG_EXPOSURE (saved)</p> <p>Blind offset acquisition loop = + (Tel offset+ AG_EXPOSURE)*3 + Tel blind offset to target + AG_EXPOSURE for check + AG_EXPOSURE (saved)</p> <p>Tel offset = up to 15 s. The Tel blind offset = up to 30 sec.</p>
A&G camera	Readout < 1 s Change of filter < 20 s
Instrument setup at the end of acquisition	SLT: 30 s
	IFU: 60 s
Delay of start of exposures	VIS: 5 s NIR: 10 s
Observations	
Detector readout	UVB 1x1, slow / fast: 68 s / 16 s 1x2, slow / fast: 34 s / 8 s 2x2, slow / fast: 17 s / 4 s
	VIS 1x1, slow / fast: 89 s / 21 s 1x2, slow / fast: 45 s / 11 s 2x2, slow / fast: 22 s / 5 s
	NIR 1.46 s
Telescope offset	15 s



4 Calibrating and reducing X-shooter data

4.1 X-shooter calibration plan

Table 19: X-shooter calibration plan.

Calibration	UVB	VIS	NIR	Frequency	Purpose
Bias	5/read. mode	5/read. mode		daily	Master bias and check CCD bias properties
NIR darks ^a			3 per DIT	daily	Master dark, bad pix. map
IFU UVB/VIS/NIR flats	1 D ₂ , 1 halo lamp	1	1 ON-OFF	bi-daily	IFU FF for monitoring of the UVB/VIS ADCs and the IFU
SLT/IFU flats	5/setting D ₂ lamp 5/setting halo. lamp	5/setting	5 ON-OFF	daily	Pixel-to-pixel variations, blaze function correction when triggered by science
Arcs single pinhole (Th/Ar or Ar/Xe/Hg/Kr)	1	1	1 ON-OFF	every 2 days	Pipeline calibration: first guess disp. solution. FMCK
Flat single pinhole ^b	1 D ₂ lamp 1 Halo. lamp	1	1 ON-OFF	every 2 days	Pipeline calibration: order localization ORDERDEF 1x1 binning in UVB/VIS
Arcs multi-pinhole (Th/Ar or Ar/Xe/Hg/Kr)	1	1	1 ON-OFF	every 2 days	Wavelength and spatial scale determination/calibration WAVE
Arcs through slit/IFU (Th/Ar or Ar/Xe/Hg/Kr)	1/setting	1/setting	1 ON-OFF / setting	daily	Wavelength shift between multi-pinholes and slits, spectral resolution, ARC, none taken in 2x2 due to remnants.
Flat multi pinhole	1	1	1 ON-OFF	on request	Multi-order definition taken on request
IFU slitlet distances				6-monthly TBC	Pipeline calibration: cube reconstruction
Radial velocity standard ^c				on request	Accurate radial vel. calibration
Telluric standard				on request	Correct for telluric lines
Spectrophotometric standard	1	1	1	daily	Response curve, absolute flux calib.
Spectroscopic skyflats				on request	Twilight spectroscopic skyflats.
Imaging mode					See corresponding section.

a: Every day darks with DITxNDITxNEXP = 1sx3x3; 5sx3x3; 300sx1x3; 600sx1x3 are taken. In addition, darks for science observations are taken (Table 20).

b: Only the 1x1 binning is taken for ORDERDEF in the UVB/VIS. Other binnings need to be requested.

c: Users have to submit their own RV standard star OBs (using the telluric star templates).



Table 20: Darks for science or standard star observations.

Science or standard		Triggered dark calibration		
DIT	NDIT	DIT	NDIT	N exposures
≤300 s	≤2	DIT	1	3
≤300 s	≥3	DIT	3	1
300 s <	≤2	DIT	1	3
300 s <	≥3	DIT	3	1

Table 21: Longterm calibration plan to monitor the instrument health.

Calibration	UVB	VIS	NIR	Frequency	Purpose
DARK_UVB_100k	3x1hour			monthly	dark
DARK_UVB_400k	3x1hour			monthly	dark
DARK_VIS_100k		3x1hour		monthly	dark
DARK_VIS_400k		3x1hour		monthly	dark
DARK_UVB_100k_1x2	3x1hour			3 months	dark
DARK_UVB_400k_1x2	3x1hour			3 months	dark
DARK_VIS_100k_1x2		3x1hour		3 months	dark
DARK_VIS_400k_1x2		3x1hour		3 months	dark
DARK_UVB_100k_2x2	3x1hour			3 months	dark
DARK_UVB_400k_2x2	3x1hour			3 months	dark
DARK_VIS_100k_2x2		3x1hour		3 months	dark
DARK_VIS_400k_2x2		3x1hour		3 months	dark
Long darks NIR			3x1hour	on request	dark
LINEARITY_UVB_100k	Set of detector FF + biases			monthly	detector monitoring
LINEARITY_UVB_400k	Set of detector FF + biases			monthly	detector monitoring
LINEARITY_VIS_100k		Set of detector FF + biases		monthly	detector monitoring
LINEARITY_VIS_400k		Set of detector FF + biases		monthly	detector monitoring
LINEARITY_UVB_100k_1x2	Set of detector FF + biases			monthly	detector monitoring
LINEARITY_UVB_400k_1x2	Set of detector FF + biases			monthly	detector monitoring
LINEARITY_VIS_100k_1x2		Set of detector FF + biases		monthly	detector monitoring
LINEARITY_VIS_400k_1x2		Set of detector FF + biases		monthly	detector monitoring
LINEARITY_UVB_100k_2x2	Set of detector FF + biases			monthly	detector monitoring
LINEARITY_UVB_400k_2x2	Set of detector FF + biases			monthly	detector monitoring
LINEARITY_VIS_100k_2x2		Set of detector FF + biases		monthly	detector monitoring
LINEARITY_VIS_400k_2x2		Set of detector FF + biases		monthly	detector monitoring
LINEARITY_NIR			Set of detector FF	monthly	detector monitoring
Imaging mode	darks	Skyflats	linearity	monthly	

4.2 Wavelength and spatial scale calibrations

The spectral format of X-shooter is relatively complex with highly curved orders, variable line tilt, dispersion, and spatial scale along each order. Using long slit arc spectra is not sufficient for wavelength calibrations, because it is essential to calibrate the change of the spatial scale (measuring only the slit height is not accurate enough).

Wavelength and spatial scale are well calibrated simultaneously with a dedicated mask of 9 equidistant pinholes present in each slit unit in combination with the ThAr lamp (Table 4, Table 7, Table 8). Exposure times for each arm are given in Table 22. Figure 39 shows an example of such a frame. The templates used for this calibration are:

XSHOOTER_slit_cal_UvbVisArcsMultiplePinhole

XSHOOTER_slit_cal_NIRArcsMultiplePinhole

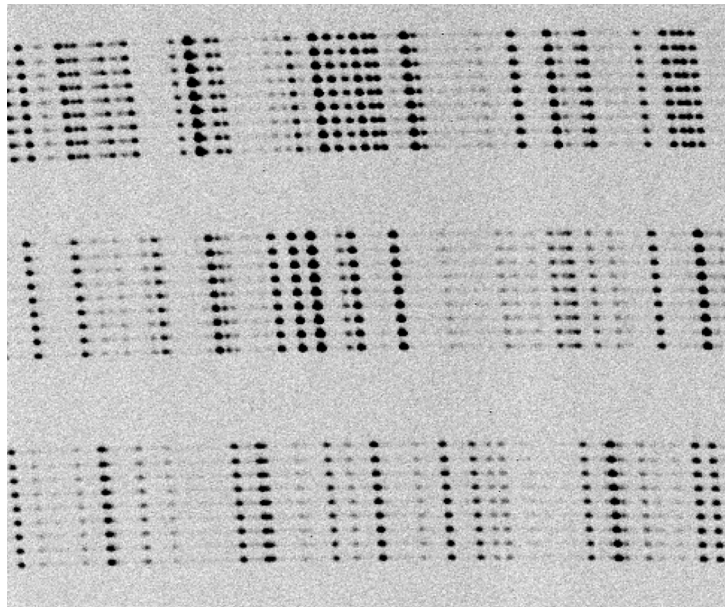

Figure 39: Part of a 9-pinhole ThAr VIS.

The accuracy of the wavelength calibration typically achieved with the ESO X-shooter Data Reduction Software is better than ~ 2 km/s over the whole wavelength range (Section 2.4.9). The quality of the list of lines used to perform the calibration is critical. In particular, they have to be carefully cleaned from blends. A ThAr line list is provided together with the X-shooter Data Reduction Software package.

The SLT ThAr spectra are useful to correct the small (fixed) displacement between the 9-pinhole masks and each slit. They are used to monitor the spectral resolution of the different spectrographs. Templates used for these calibrations are:

XSHOOTER_slit_cal_UVBVisArcs

XSHOOTER_slit_cal_NIRArcs

XSHOOTER_ifu_cal_UVBVisArcs

XSHOOTER_ifu_cal_UVBVisArcs



4.3 Flatfield calibrations

Flatfield spectra allow to correct for the pixel-to-pixel variations in the detector sensitivity as a function of impinging wavelength of the light and to correct for the structures introduced by imperfections of the slits. They also provide a good correction of the blaze function. Low frequency fringes with peak-to-peak amplitudes up to ~5% are present in the red part of the VIS spectra.

For each arm, a dedicated halogen lamp with appropriate balancing filters is available to give well-exposed, flat continuum spectra at all wavelengths within a reasonably short exposure time (Table 22). A deuterium lamp is used for the spectral region shortward of 350 nm. Flatfielding the whole spectral range requires five exposures (two in UVB, one in VIS, and ON/OFF in NIR). Flatfield templates are:

XSHOOTER_slit_cal_UVBLowLampFlat (UVB deuterium-D₂- lamp flat)
 XSHOOTER_slit_cal_UVBHighLampFlat (UVB halogen lamp flat)
 XSHOOTER_slit_cal_VISLampFlat
 XSHOOTER_slit_cal_NIRLampFlat
 and their equivalent for IFU flatfields named XSHOOTER_ifu_cal_...LampFlat.

Table 22: Exposure times for arc and flatfield frames. Values are given for the fast readout, low gain mode (in UVB and VIS) for 1.0" or 0.9" slits, and the IFU. These values can be adapted to other slit widths and readout modes applying a simple scaling and should be closed to those in this table.

UVB 1x1, low gain			VIS 1x1 low gain		NIR	
ThAr arc lamp						
Slit 1.0"	30 s		Slit 0.9"	5 s	Slit 0.9"	0.66 s
IFU	45 s		IFU	4 s	IFU	1.32 s
9-pin.	15 s		9-pin.	10 s	9-pin.	0.66 s
Flatfield						
Slit 1.0"	D ₂	7.3 s	Slit 0.9"	18.8 s	Slit 0.9"	20 s
	Halo	19.3 s				
IFU	D ₂	14 s	IFU	52 s	IFU	30 s
	Halo	32 s				

4.4 Spectroscopic skyflats

Spectroscopic skyflats (SLIT and IFU modes) can be requested and will be taken on best effort basis. Tests show that the slits are uniformly illuminated.

4.5 Attached calibrations

It is possible to attach arc and flatfield calibrations to an OB. We strongly discourage taking attached arcs in the VIS, because of remnants caused by strong ThAr lines. These remnants persist in the following exposures for up to one hour. Attached VIS arcs will be granted only in visitor mode and in service mode for observations that will be executed at the very end of the night. The user should refer to Table 22 for the exposure times. For the UVB arm, an arc exposure of 6 s in the 1x1 binning, 3 s in the 1x2 binning, and 1 s in the 2x2 binning with the normal readout speed does not produce remnants and should provide enough lines for an



accurate radial velocity calibration. The wavelength calibration in the pipeline is not performed with ARC frames, but with the 2dmap frames (9 pinholes + ARC lamp). It is possible to add these templates in the science OBs if a higher accuracy of wavelength calibration is required.

The attached calibration template must follow the corresponding science template, because it uses the setup of the instrument performed by the science template. If one executes the attached calibration immediately after the acquisition template, the system will use the setup corresponding to the AFC. Therefore, to bracket a science observation with attached flat fields, one needs to create an OB like this: acquisition template - dummy exposures with a science template with correct instrument setup - attached calibration flat fields - science template - attached calibration.

4.6 Spectrophotometric calibration

Spectrophotometric standard stars are used to obtain the absolute efficiency of the instrument and derive an absolute flux calibration of the science data. These observations are conducted by the Observatory with the wide 5" slits with dedicated templates in NODDING mode:

XSHOOTER_slit_cal_StandardStar
XSHOOTER_ifu_cal_StandardStar

The classical set of UV-optical standard stars from Oke (1990, AJ 99, 1621) and Hamuy et al. (1994, PASP 106, 566) do not cover the whole spectral range of X-shooter, thus making calibration of the full spectral range problematic. To remedy this situation a dedicated 2 years observing campaign has been undertaken as an ESO Observatory Programme (PID 278.D-5008) to extend to the near-IR a subset of 12 standard stars from the two references cited above to the near-infrared. Tabulated fluxes used by the pipeline for those 12 stars from 300 nm to 2500 nm allow an absolute flux calibration to 5-10%. Details of this programme can be found in Vernet et al. (Proc. SPIE 7016, 2008).

Currently 6 spectrophotometric standard stars are available and are fully flux calibrated, see http://www.eso.org/sci/facilities/paranal/instruments/xshooter/tools/specphot_list.html

If you use the fluxes available in the X-shooter pipeline, please cite:

[Vernet, Kerber, Mainieri et al. 2010, Highlights of Astronomy, Volume 15, p. 535-535](#)
and [Hamuy et al. 1994, PASP, 106, 566.](#)

4.7 Telluric lines correction

The visual-red and a near-infrared part of the spectrum are strongly affected by the absorption lines of the Earth's atmosphere. Many of these telluric lines do not scale linearly with airmass. For correction with a telluric standard star, the standard method is to observe a star with a well-known spectrum at the same airmass and with the same instrument setup as the science target. The strengths of the telluric lines vary with time, so it is also necessary to observe a telluric standard soon after or just before the science observation. Two templates are designed for this purpose:

XSHOOTER_slit_cal_TelluricStd
XSHOOTER_ifu_cal_TelluricStd

Usually, main sequence hot stars (B0 to B9) or solar analogs from the Hipparcos Catalog are selected. However, hot stars contain hydrogen and helium lines, which can be difficult to



remove. If the regions around the hydrogen and helium lines are of interest, a late type star should be chosen. Some hot stars also have emission lines or are in dusty regions. These stars should be avoided. The V-I color of the star can be used as an indicator of dust (for stars hotter than A0, V-I should be negative). And lastly, hot stars tend to lie near the galactic plane and it may be difficult to find nearby hot stars for some targets.

Solar analogs are stars with spectral type G0V to G3V. These standards have many absorption lines in the near-infrared, particularly in the J band. The features can be removed by dividing by the solar spectrum that has been degraded to the resolution of the observations. In addition to hot stars and solar analogs, F dwarfs are commonly used.

Observers should think carefully which stellar type is the best for their program. Users that require a telluric standard star are required to submit the corresponding calibration in concatenation with the science. The [Telluric Standard Star Catalogue Search Tool](#) can be used to find appropriate stars (the "Hipparcos/2MASS B stars single" catalogue contains a list of single, B-type, main-sequence stars, verified in previous X-shooter observations). Telluric standard stars should have at least about 10000 ADUs in the middle of the brightest orders of each arm (S/N ~ 50-100). The time will be charged to the program. The telluric standard star observations can be performed in NODDING and with the fast readout mode in the UVB/VIS arms, irrespective of the readout speed used for the science. The binning should match the science OB.

The standard calibration plan does not include telluric standard stars for each science observation. The Observatory will only obtain one telluric for each instrument setting observed during the night. No constraints on airmass and time constraints will be imposed. Users are encouraged to use Molecfit (<http://www.eso.org/sci/software/pipelines/skytools/>), which can provide accurate telluric line corrections in most cases, provided that a spectral region of about 10-40 nm is mostly free of intrinsic spectral features, but is instead affected by telluric absorption lines of low or moderate optical depths caused by water vapor. The signal-to-noise ratio per pixel in this spectral range should be larger than 5 per Observing Block. In the VIS, suggested spectral regions are 810-830 nm or 940-951 nm. In the NIR, suggested regions are 1300-1321 nm, 1745-1785 nm. Observation of a telluric standard star is recommended in other cases, such as if

- (a) the VIS or NIR spectrum shows low flux in all regions affected by telluric water vapor lines of low or moderate optical depths, so that the signal-to-noise ratio per resolution element is not expected to be larger than 10 per OB in any of these regions;
- (b) the whole VIS or NIR spectrum is affected by strong intrinsic absorption lines.

The execution time for the observation(s) of the telluric standard star (1 per Observing Block of the science target) must be included in the phase 1 proposal and be submitted in concatenation with the science during phase 2. The [Telluric Standard Star Catalogue Search Tool](#) can be used to find appropriate stars (the "Hipparcos/2MASS B stars single" catalogue contains a list of single, B-type, main-sequence stars, verified in previous X-shooter observations).

4.8 The ESO X-shooter pipeline

The ESO X-shooter pipeline is released with REFLEX support. With REFLEX, the data organization is done via a script. Several esorex recipes are user-interactive, allowing the re-running of recipes with modified parameter values. The pipeline supports both instrument modes (SLT and IFU) and is available at: <http://www.eso.org/sci/software/pipelines/>.



The pipeline delivers sky subtracted, cosmic ray cleaned, flux, and wavelength calibrated 2D spectra, rectified to a regular grid in wavelength and spatial directions. 1D extracted spectra are produced when a bright object is detected. It is also possible to specify a region where the spectrum is located. 3D reconstructed data cubes will be produced for IFU data. Additional products are delivered to verify the data quality and a set of Quality Control parameters, instrument health check, and trend analysis.

Some of the functionalities are still in development. More information is available in the pipeline user manual and in the pipeline website at:

<http://www.eso.org/observing/dfo/quality/pipeline-status.html#XSHOOTER>

Information on the current pipeline problems and limits is available at:

http://www.eso.org/observing/dfo/quality/XSHOOTER/pipeline/pipe_problems.html

If you use the X-shooter pipeline, please cite Modigliani et al. [2010SPIE.7737E..56M](#)

X-shooter reduced spectra are released via the ESO archive as part of the ESO Phase 3 Data Products. Phase 3 denotes the process of preparation, validation and ingestion of science data products (SDPs) for storage in the ESO science archive facility, and subsequent data publication to the scientific community. Reduced X-shooter spectra are available through the Phase 3 spectral query form: http://archive.eso.org/wdb/wdb/adp/phase3_spectral/form

4.9 Frequently Asked Questions

- *Can I check the instrument health?*

The instrument health is monitored daily and some Quality Control plots can be found at:

http://www.eso.org/observing/dfo/quality/XSHOOTER/reports/HEALTH/trend_report_BIAS_U_VB_med_master_HC.html

- *Is it possible to do pre-imaging with the A&G TCCD?*

Not, but it has been successfully used during VM runs to prepare OBs with blind offsets.

- *Is it possible to do nodding in 1 arm only, the NIR one for instance?*

No, this is not possible.

- *Can one skip the AFC?*

It is possible to occasionally skip the AFC for observations done near zenith, with a wide slit, and/or under bad seeing. However, this is not a recommended action since it may make spectra extraction difficult (the object is no longer at the expected position along the slit). It may also lead to slit losses. The AFC takes into account the spectrograph flexures with respect to the WAVE calibration at daytime and should be used for the data reduction.

- *What is the frequency of the AFC?*

It is recommended to do the AFC every hour to correct for the instrument flexures. Only the backbone flexures are measured, not the internal spectrograph flexures. It is possible to add AFC templates in long OBs between two science templates (useful in case of long OBs with a fixed slit position angle).

- *Does the slit follow the parallactic angle during an exposure?*



The parallactic angle is only computed during the acquisition/preset and the angle of the rotator is set at that time. During the integration, the slit position angle will then remain fixed on sky, i.e., it will not follow the parallactic angle.

- *How can I find the slit-object position in the acquisition image?*

FITS header keywords HIERARCH ESO SEQ AG XCEN and YCEN record the location of the center of the SLIT or IFU in the image.

- *Which airmass should I specify for IFU observations?*

The ADCs are not used in IFU mode and one should thus avoid large airmasses (choose airmass < 1.5, if possible). The tip/tilt mirrors are used to correct for some of the differential atmospheric refraction.

Further useful websites regarding instrument issues and OB preparation are:

http://www.eso.org/observing/dfo/quality/XSHOOTER/qc/problems/problems_xshooter.html

<http://www.eso.org/sci/observing/phase2/SMGuidelines/FAQP2.html>

<http://www.eso.org/sci/facilities/paranal/instruments/xshooter/index.html>

In case of instrumental question please contact xshooter@eso.org.

In case of questions regarding phase 1 and phase 2, please contact usd-help@eso.org.

5 Reference material

5.1 Templates

In the following sections the X-shooter templates are listed with their free and fixed parameters. When using the p2 tool, the user has to fill only the fields (keywords) shown on white background in the following tables. Keywords shown on gray background are fixed within the template itself and can only be modified by the astronomer operating the instrument.

5.1.1 Orientation and offset conventions

X-shooter follows the standard astronomical offset conventions and definitions. The positive position angle (PA) is defined from North to East. This value should be entered in the TEL.ROT.OFFANGLE in the acquisition templates and is used to set the slit position angle on the sky. The fits header keyword HIEARCH ESO ADA POSANG in all X-shooter data is minus the slit position angle on the sky. The ADA.POSANG keyword in the header indicates the opposite of the slit angle specified by the user and corresponds to the rotator angle. The value "9999" can be used to set the position angle to the parallactic angle. The parallactic angle is the one at the time of the preset/acquisition. The slit is not maintained at the parallactic angle during the science exposure.

Offsets are always given in arcseconds, but the reference system can be chosen to be the sky (Alpha,Delta) or the X-shooter slit coordinate system (X,Y). Offset conventions are illustrated in Figure 40. Templates use cumulative offsets: the position at a given time is derived from the sum of all offsets specified so far in the template. For example, the series of offsets: 0, -10, 0, 10 brings the telescope back to the original position for the last exposure.

TEL.ROT.OFFANGLE in the acquisition templates is the keyword to set the slit position angle on sky. A value of 9999 (default) means that the parallactic angle is used. The parallactic angle is not followed during the exposure, i.e., the slit position angle is fixed to the parallactic angle at the start of the OB. If another slit position angle is defined, the telescope will follow this angle on sky.

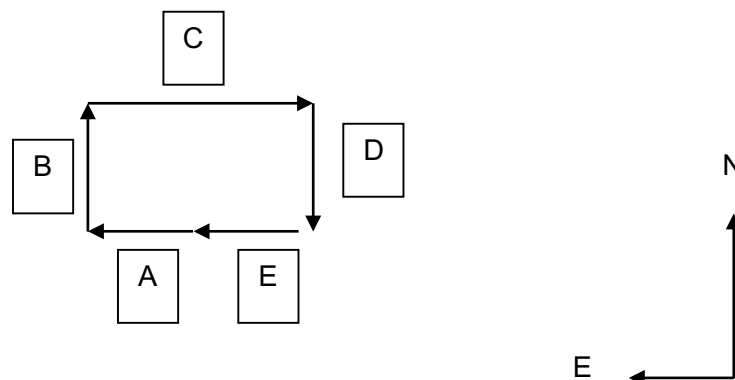

Figure 40: Example of an offset series: offset A = (RA = +10", DEC = 0"), offset B = (RA = 0", DEC = +10"), offset C = (RA = -20", DEC = 0"), offset D = (RA = 0", DEC = -10"), offset E = (RA = +10", DEC = 0") and the telescope is back to the original position.

The convention is to use angles from 0 to +180 degrees and from 0 to -180 degrees. For a slit position angle of +45 degrees, one needs to enter +45 degrees in the acquisition template. For

a slit position angle of 315 degrees, one needs to enter an angle of -45 degrees ($= 315-360$) in the acquisition template.

The offsets in all templates are offsets on sky. They are computed as follows: 'offset RA = $(\Delta RA) \cdot \cos(DEC)$ ' and 'offset DEC = ΔDEC '. It is important to specify the proper motions of the objects.

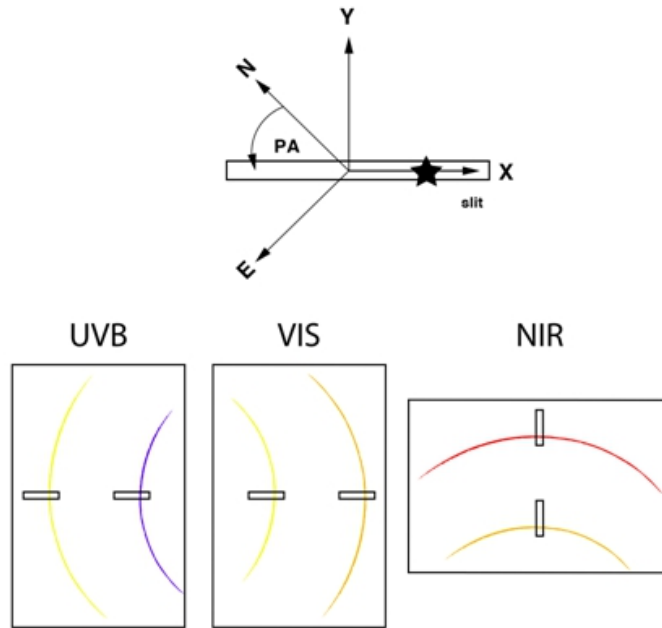

Figure 41: Slit coordinate system and relation between object position in the slit and position on the spectrum. An object at positive x (black star top panel) produces spectra placed as illustrated in the bottom panels. A positive offset in the x or y direction will move the object in direction of +x and +y axis.

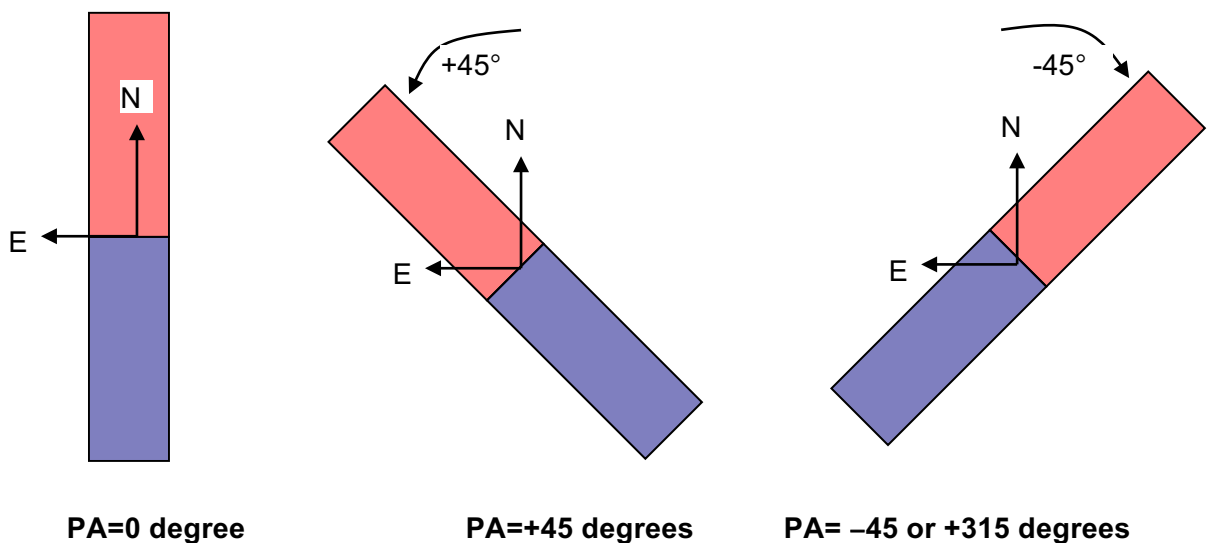

Figure 42: A positive offset in the x or y direction will move the object in direction of +x and +y axis.

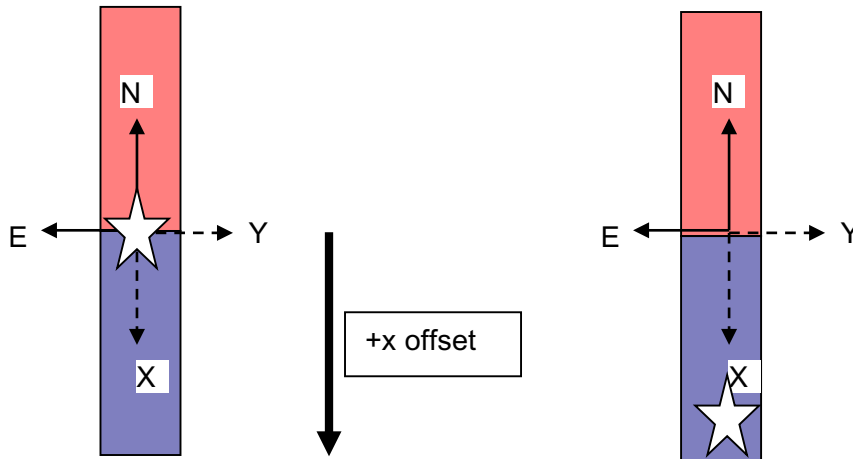

Figure 43: A positive offset in $+x$ moves the star in the direction of the $+x$ axis and the slit in the $-x$ axis.

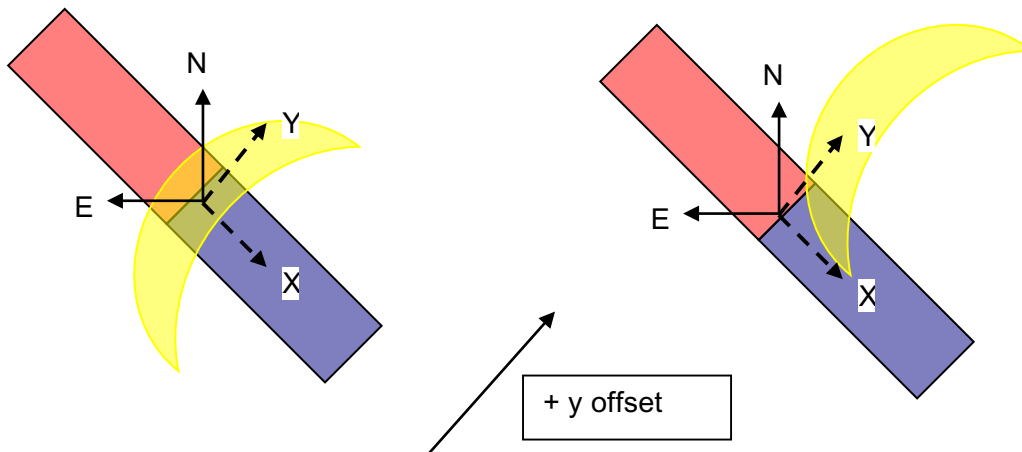

Figure 44: The offset with PA= $+45$ degrees shows a positive offset in y axis. The object moves in $+y$, while the slit moves in the $-y$ axis.



5.1.2 SLT and IFU acquisition templates

We encourage the users to select the filter in which the target is best visible and to use the shortest possible acquisition exposure time for a minimum acquisition overhead.

XSHOOTER_slit_acq			
<i>Keyword</i>	<i>Range</i>	<i>Default Value</i>	<i>Label</i>
<i>Free parameters</i>			
TEL.TARG.ALPHA		000000.000	Target RA
TEL.TARG.DELTA		000000.000	Target DEC
TEL.TARG.EQUINOX	-2000..3000	2000	Equinox
TEL.TARG.PMA	-10.0..10.0	0.0	RA proper motion ("/yr)
TEL.TARG.PMD	-10.0..10.0	0.0	DEC proper motion ("/yr)
TEL.TARG.EPOCH	1950, 2000	2000	Epoch
TEL.TARG.ADDVELALPHA		0.0	RA differential tracking velocity ("/s)
TEL.TARG.ADDVELDELTA		0.0	DEC differential tracking velocity ("/s)
TEL.TARG.OFFSETALPHA	-36000 .. 36000	0.0	RA blind offset (")
TEL.TARG.OFFSETDELTA	-36000 .. 36000	0.0	DEC blind offset (")
TEL.ROT.OFFANGLE	-179.99..179.99 9999.	9999.	Slit position angle on Sky 9999. for parallactic angle
INS.FILT1.NAME	u', g', r', i', z', U, B, V, R, I		A&G filter
DET4.WIN1.UIT1	0..36000		TCCD exposure time
TEL.AG.GUIDESTAR	CATALOGUE, SETUPFILE, NONE	CATALOGUE	Telescope guide star selection mode
TEL.GS1.ALPHA		0.0	Guide Star RA
TEL.GS1.DELTA		0.0	Guide Star DEC
<i>Fixed parameters</i>			
DET1.WIN1.UIT1		2	AFC UVB exposure time
DET2.WIN1.UIT1		0.5	AFC VIS exposure time
DET3.DIT		1	AFC NIR DIT
DET3.NDIT		1	number of AFC NIR DITs
SEQ.AFC.CORRECT	F, T	T	AFC correct flag
SEQ.AFC.WSIZE		64	Window size for AFC Cross Correlation
SEQ.AFC.MAXD		20	Maximum distance for AFC Cross Correlation
SEQ.PRESET	T, F	T	Preset flag
INS.MODE	SLITSPEC, IFUSPEC	SLITSPEC	Instrument mode



XSHOOTER_slit_acq_rrm			
<i>Keyword</i>	<i>Range</i>	<i>Default Value</i>	<i>Label</i>
<i>Free parameters</i>			
SEQ.RRM.REGISTER	T, F	T	Register OB in RRM system
SEQ. RRM.VISITOR	T, F	T	Allow RRM activation in visitor mode
TEL.TARG.DELTA		000000.000	Target DEC
TEL.TARG.EQUINOX	-2000..3000	2000	Equinox
TEL.TARG.PMA	-10.0..10.0	0.0	RA proper motion ("/year)
TEL.TARG.PMD	-10.0..10.0	0.0	DEC proper motion ("/year)
TEL.TARG.EPOCH	1950, 2000	2000	Epoch
TEL.TARG.ADDVELALPHA		0.0	RA differential tracking velocity ("/s)
TEL.TARG.ADDVELDELTA		0.0	DEC differential tracking velocity ("/s)
TEL.TARG.OFFSETALPHA	-36000..36000	0.0	RA blind offset (")
TEL.TARG.OFFSETDELTA	-36000..36000	0.0	DEC blind offset (")
TEL.ROT.OFFANGLE	-179.99 ... 179.99, 9999.	9999.	Slit position angle on Sky 9999. for parallactic angle
INS.FILT1.NAME	u', g', r', i', z', U, B, V, R, I		A&G filter
DET4.WIN1.UIT1	0..36000		TCCD exposure time
TEL.AG.GUIDESTAR	CATALOGUE, SETUPFILE, NONE	CATALOGUE	Telescope guide star selection mode
TEL.GS1.ALPHA		0.0	Guide Star RA
TEL.GS1.DELTA		0.0	Guide Star DEC
<i>Fixed parameters</i>			
DET1.WIN1.UIT1		2	AFC UVB exposure time
DET2.WIN1.UIT1		0.5	AFC VIS exposure time
DET3.DIT		1	AFC NIR DIT
DET3.NDIT		1	number of AFC NIR DITs
SEQ.AFC.CORRECT	F, T	T	AFC correct flag
SEQ.AFC.WSIZE		64	Window size for AFC Cross Correlation
SEQ.AFC.MAXD		20	Maximum distance for AFC Cross Correlation
SEQ.PRESET	T, F	T	Preset flag
INS.MODE	SLITSPEC, IFUSPEC	SLITSPEC	Instrument mode



XSHOOTER_ifu_acq			
<i>Keyword</i>	<i>Range</i>	<i>Default Value</i>	<i>Label</i>
<i>Free parameters</i>			
TEL.TARG.ALPHA		000000.000	Target RA
TEL.TARG.DELTA		000000.000	Target DEC
TEL.TARG.EQUINOX	-2000..3000	2000	Equinox
TEL.TARG.EPOCH	1950, 2000	2000	Epoch
TEL.TARG.PMA	-10.0..10.0	0.0	RA proper motion ("/year)
TEL.TARG.PMD	-10.0..10.0	0.0	DEC proper motion ("/year)
TEL.TARG.ADDVELALPHA		0.0	Additional velocity RA in "/s
TEL.TARG.ADDVELDELTA		0.0	Additional velocity DEC in "/s
TEL.TARG.OFFSETALPHA		0.0	RA blind offset (")
TEL.TARG.OFFSETDELTA		0.0	DEC blind offset (")
TEL.ROT.OFFANGLE	-179.99..179.99, 9999.	9999.	IFU position angle on Sky 9999. for parallactic angle
INS.FILT1.NAME	u', g', r', i', z', U, B, V, R, I		A&G filter
DET4.WIN1.UIT1	0..36000		TCCD exposure time
SEQ.IFU.WLGT	300..2000	470	Wavelength for target centring and tracking
TEL.AG.GUIDESTAR	CATALOGUE, SETUPFILE, NONE	CATALOGUE	Telescope guide star selection mode
TEL.GS1.ALPHA		0.0	Guide Star RA
TEL.GS1.DELTA		0.0	Guide Star DEC
<i>Fixed parameters</i>			
DET1.WIN1.UIT1		2	AFC UVB exposure time
DET2.WIN1.UIT1		0.5	AFC VIS exposure time
DET3.DIT		1	AFC NIR DIT
DET3.NDIT		1	Number of AFC NIR DITs
SEQ.AFC.CORRECT	F, T	T	AFC correct flag
SEQ.AFC.MAXD		20	Maximum distance for AFC cross correlation
SEQ.AFC.WSIZE		64	Window size for AFC cross correlation
SEQ.PRESET	T, F	T	Preset flag
INS.MODE	SLITSPEC, IFUSPEC	IFUSPEC	Instrument mode



XSHOOTER_ifu_acq_rrm			
<i>Keyword</i>	<i>Range</i>	<i>Default Value</i>	<i>Label</i>
<i>Free parameters</i>			
SEQ.RRM.REGISTER	T, F	T	Register OB in RRM system
SEQ. RRM.VISITOR	T, F	T	Allow RRM activation in visitor mode
TEL.TARG.ALPHA		000000.000	Target RA
TEL.TARG.DELTA		000000.000	Target DEC
TEL.TARG.EQUINOX	-2000..3000	2000	Equinox
TEL.TARG.EPOCH	1950, 2000	2000	Epoch
TEL.TARG.PMA	-10.0..10.0	0.0	RA proper motion ("/year)
TEL.TARG.PMD	-10.0..10.0	0.0	DEC proper motion ("/year)
TEL.TARG.ADDVELALPHA		0.0	Additional velocity RA in "/s
TEL.TARG.ADDVELDELTA		0.0	Additional velocity DEC in "/s
TEL.TARG.OFFSETALPHA		0.0	RA blind offset (")
TEL.TARG.OFFSETDELTA		0.0	DEC blind offset (")
TEL.ROT.OFFANGLE	-179.99..179.99, 9999.	9999.	IFU position angle on Sky 9999. for parallactic angle
INS.FILT1.NAME	u', g', r', i', z', U, B, V, R, I		A&G filter
DET4.WIN1.UIT1	0..36000		TCCD exposure time
SEQ.IFU.WLGT	300..2000	470	Wavelength for target centring and tracking
TEL.AG.GUIDESTAR	CATALOGUE, SETUPFILE, NONE	CATALOGUE	Telescope guide star selection mode
TEL.GS1.ALPHA		0.0	Guide Star RA
TEL.GS1.DELTA		0.0	Guide Star DEC
<i>Fixed parameters</i>			
DET1.WIN1.UIT1		2	AFC UVB exposure time
DET2.WIN1.UIT1		0.5	AFC VIS exposure time
DET3.DIT		1	AFC NIR DIT
DET3.NDIT		1	Number of AFC NIR sub-integrations (NDIT)
SEQ.AFC.CORRECT	F, T	T	AFC correct flag
SEQ.AFC.MAXD		20	Maximum distance for AFC cross correlation
SEQ.AFC.WSIZE		64	Window size for AFC cross correlation
SEQ.PRESET	T, F	T	Preset flag
INS.MODE	SLITSPEC, IFUSPEC	IFUSPEC	Instrument mode



5.1.3 Flexure compensation templates

The flexures compensation is always performed within the acquisition template. Two stand-alone AFC templates (XSHOOTER_slit_AFC, XSHOOTER_ifu_AFC) for additional flexure compensations in case of long OBs (> 1 h) can be inserted between two science templates.

5.1.4 Science templates

5.1.4.1 SLT observation templates

XSHOOTER_slit_obs_Stare			
<i>Keyword</i>	<i>Range</i>	<i>Default Value</i>	<i>Label</i>
<i>Free parameters</i>			
INS.OPTI3.NAME	see Table 4	1.0x11	UVB slit
INS.OPTI4.NAME	see Table 7	0.9x11	VIS slit
INS.OPTI5.NAME	see Table 8	0.9x11	NIR slit
DET1.WIN1.UIT1	0..36000		UVB Exposure Time (s)
DET1.READ.CLKDESCR	see Table 5	100k/1pt/hg	UVB readout mode
DET2.WIN1.UIT1	0..36000		VIS Exposure Time (s)
DET2.READ.CLKDESCR	see Table 5	100k/1pt/hg	VIS readout mode
DET3.DIT	0..36000		NIR Detector Integration Time (s)
DET3.NDIT	1..20	1	number of DITs
SEQ.NEXPO.UVB	0..100	1	UVB number of exposures
SEQ.NEXPO.VIS	0..100	1	VIS number of exposures
SEQ.NEXPO.NIR	0..100	1	NIR number of exposures
<i>Fixed Values</i>			
INS.MODE	SLITSPEC, IFUSPEC	SLITSPEC	Instrument Mode
SEQ.AGSNAPSHOT	T, F	F	Acquisition image before science exposures

XSHOOTER_slit_obs_StareSynchro			
<i>Keyword</i>	<i>Range</i>	<i>Default Value</i>	<i>Label</i>
<i>Free parameters</i>			
INS.OPTI3.NAME	see Table 4	1.0x11	UVB slit
INS.OPTI4.NAME	see Table 7	0.9x11	VIS slit
INS.OPTI5.NAME	see Table 8	0.9x11	NIR slit
DET1.WIN1.UIT1	0..36000		UVB exposure time (s)
DET1.READ.CLKDESCR	see Table 5	100k/1pt/hg	UVB readout mode
DET2.WIN1.UIT1	0..36000		VIS exposure time (s)
DET2.READ.CLKDESCR	see Table 5	100k/1pt/hg	VIS readout mode
DET3.DIT	0.66..36000		NIR Detector Integration Time (s)
DET3.NDIT	1..9999	1	number of DITs
<i>Fixed Values</i>			
INS.MODE	SLITSPEC, IFUSPEC	SLITSPEC	Instrument Mode
SEQ.AGSNAPSHOT	T, F	F	Acquisition image before science exposures?



XSHOOTER_slit_obs_AutoNodOnSlit			
<i>Keyword</i>	<i>Range</i>	<i>Default Value</i>	<i>Label</i>
<i>Free parameters</i>			
INS.OPTI3.NAME	see Table 4	1.0x11	UVB slit
INS.OPTI4.NAME	see Table 7	0.9x11	VIS slit
INS.OPTI5.NAME	see Table 8	0.9x11	NIR slit
DET1.WIN1.UIT1	0..36000		UVB exposure time (s)
DET1.READ.CLKDESCR	see Table 5	100k/1pt/hg	UVB readout mode
DET2.WIN1.UIT1	0..36000		VIS exposure time (s)
DET2.READ.CLKDESCR	see Table 5	100k/1pt/hg	VIS readout mode
DET3.DIT	0..36000		NIR Detector Integration Time (s)
DET3.NDIT	1..9999	1	Number of DITs
SEQ.NEXP.UVB	0..100	1	UVB number of exposures per offset position
SEQ.NEXP.VIS	0..100	1	VIS number of exposures per offset position
SEQ.NEXP.NIR	0..100	1	NIR number of exposures per offset position
SEQ.SKYTHROW	0..10	5	Nod Throw in “
SEQ.JITTER.WIDTH	0..2	0	Jitter box width in “
SEQ.NABCYCLES	0..100	1	Number AB or BA cycles
SEQ.OFFSET.ZERO	T, F	T	Return to Origin?
<i>Fixed Values</i>			
INS.MODE	SLITSPEC, IFUSPEC	SLITSPEC	Instrument Mode
SEQ.AGSNAPSHOT	T, F	F	Acquisition image before science exposures?

XSHOOTER_slit_obs_FixedSkyOffset			
<i>Keyword</i>	<i>Range</i>	<i>Default Value</i>	<i>Label</i>
<i>Free parameters</i>			
INS.OPTI3.NAME	see Table 4	1.0x11	UVB slit
INS.OPTI4.NAME	see Table 7	0.9x11	VIS slit
INS.OPTI5.NAME	see Table 8	0.9x11	NIR slit
DET1.WIN1.UIT1	0..36000		UVB Exposure Time (s)
DET1.READ.CLKDESCR	see Table 5	100k/1pt/hg	UVB read-out mode
DET2.WIN1.UIT1	0..36000		VIS Exposure Time (s)
DET2.READ.CLKDESCR	see Table 5	100k/1pt/hg	VIS read-out mode
DET3.DIT	0.66..36000		NIR Detector Integration Time (s)
DET3.NDIT	1..20	1	number of DITs
SEQ.NEXP.UVB	0..100	1	UVB number of exposures per offset position
SEQ.NEXP.VIS	0..100	1	VIS number of exposures per offset position
SEQ.NEXP.NIR	0..100	1	NIR number of exposures per offset position
SEQ.FIXOFF.RA	-100..100	0	RA fixed offset (“)



SEQ.FIXOFF.DEC	-100..100	0	DEC fixed offset (")
SEQ.JITTER.WIDTH	0..2	0	Jitter box width in "
SEQ.NABCYCLES	0..100	1	Number OS or SO cycles
SEQ.OFFSET.ZERO	T, F	T	Return to Origin?
<i>Fixed Values</i>			
INS.MODE	SLITSPEC, IFUSPEC	SLITSPEC	Instrument Mode
SEQ.AGSNAPSHOT	T, F	F	Acquisition image before science exposures?

XSHOOTER_slit_obs_GenericOffset			
<i>Keyword</i>	<i>Range</i>	<i>Default Value</i>	<i>Label</i>
<i>Free parameters</i>			
INS.OPTI3.NAME	see Table 4	1.0x11	UVB slit
INS.OPTI4.NAME	see Table 7	0.9x11	VIS slit
INS.OPTI5.NAME	see Table 8	0.9x11	NIR slit
DET1.WIN1.UIT1	0..36000		UVB exposure time (s)
DET1.READ.CLKDESCR	see Table 5	100k/1pt/hg	UVB readout mode
DET2.WIN1.UIT1	0..36000		VIS exposure time (s)
DET2.READ.CLKDESCR	see Table 5	100k/1pt/hg	VIS readout mode
DET3.DIT	0..36000		NIR Detector Integration Time (s)
DET3.NDIT	1..20	1	number of DITs
SEQ.NEXP.UVB	0..100	1	UVB number of exposures per offset position
SEQ.NEXP.VIS	0..100	1	VIS number of exposures per offset position
SEQ.NEXP.NIR	0..100	1	NIR number of exposures per offset position
SEQ.OFFSET.COORDS	SKY,SLIT	SKY	Offset coordinate type (RA/DEC or X/Y) in "
SEQ.RELOFF1	-1000..1000	0	List of RA/X offsets (")
SEQ.RELOFF2	-1000..1000	0	List of DEC/Y offsets (")
SEQ.OBS.TYPE	O,S	O S	List of observation type (object or sky)
SEQ.NOFFSET	0..100	2	Number of offsets
SEQ.OFFSET.ZERO	T, F	T	Return to Origin
<i>Fixed Values</i>			
INS.MODE	SLITSPEC, IFUSPEC	SLITSPEC	Instrument Mode
SEQ.AGSNAPSHOT	T, F	F	Acquisition image before science exposures?

5.1.4.2 IFU observation templates

XSHOOTER_ifu_obs_Stare			
<i>Keyword</i>	<i>Range</i>	<i>Default Value</i>	<i>Label</i>



<i>Free parameters</i>			
DET1.WIN1.UIT1	0..36000		UVB exposure time (s)
DET1.READ.CLKDESCR	see Table 5	100k/1pt/hg	UVB readout mode
DET2.WIN1.UIT1	0..36000		VIS exposure time (s)
DET2.READ.CLKDESCR	see Table 5	100k/1pt/hg	VIS readout mode
DET3.DIT	0..36000		NIR Detector Integration Time (s)
DET3.NDIT	1..20	1	number of DITs
SEQ.NEXP.UVB	0..100	1	UVB number of exposures
SEQ.NEXP.VIS	0..100	1	VIS number of exposures
SEQ.NEXP.NIR	0..100	1	NIR number of exposures
<i>Fixed Values</i>			
INS.MODE	SLITSPEC, IFUSPEC	IFUSPEC	Instrument Mode
INS.OPTI3.NAME	see Table 4	1x12.6	UVB slit
INS.OPTI4.NAME	see Table 7	1x12.6	VIS slit
INS.OPTI5.NAME	see Table 8	1x12.6	NIR slit
SEQ.AGSNAPSHOT	T, F	F	Acquisition image before science exposures?

XSHOOTER_slit_ifu_StareSynchro			
<i>Keyword</i>	<i>Range</i>	<i>Default Value</i>	<i>Label</i>
<i>Free parameters</i>			
DET1.WIN1.UIT1	0..36000		UVB exposure time (s)
DET1.READ.CLKDESCR	see Table 5	100k/1pt/hg	UVB readout mode
DET2.WIN1.UIT1	0..36000		VIS exposure time (s)
DET2.READ.CLKDESCR	see Table 5	100k/1pt/hg	VIS readout mode
DET3.DIT	0..36000		NIR Detector Integration Time (s)
DET3.NDIT	1..20	1	number of DITs
<i>Fixed Values</i>			
INS.MODE	SLITSPEC, IFUSPEC	IFUSPEC	Instrument Mode
INS.OPTI3.NAME	see Table 4	1x12.6	UVB Slit slide
INS.OPTI4.NAME	see Table 7	1x12.6	VIS Slit slide
INS.OPTI5.NAME	see Table 8	1x12.6	NIR Slit slide
SEQ.AGSNAPSHOT	T, F	F	Acquisition image before science exposures?

XSHOOTER_slit_ifu_FixedSkyOffset			
<i>Keyword</i>	<i>Range</i>	<i>Default Value</i>	<i>Label</i>
<i>Free parameters</i>			
DET1.WIN1.UIT1	0..36000		UVB exposure time (s)
DET1.READ.CLKDESCR	see Table 5	100k/1pt/hg	UVB readout mode
DET2.WIN1.UIT1	0..36000		VIS exposure time (s)
DET2.READ.CLKDESCR	see Table 5	100k/1pt/hg	VIS readout mode
DET3.DIT	0..36000		NIR Detector Integration Time (s)
DET3.NDIT	1..20	1	number of DITs



SEQ.NEXP.UVB	0..100	1	UVB number of exposures per offset position
SEQ.NEXP.VIS	0..100	1	VIS number of exposures per offset position
SEQ.NEXP.NIR	0..100	1	NIR number of exposures per offset position
SEQ.FIXOFF.RA	-100..100	0	RA fixed offset (")
SEQ.FIXOFF.DEC	-100..100	0	DEC fixed offset (")
SEQ.JITTER.WIDTH	0..2	0	Jitter box width in "
SEQ.NABCYCLES	0..100	1	Number OS or SO cycles
SEQ.OFFSET.ZERO	T, F	T	Return to Origin?
<i>Fixed Values</i>			
INS.MODE	SLITSPEC, IFUSPEC	IFUSPEC	Instrument Mode
INS.OPTI3.NAME	see Table 4	1x12.6	UVB slit
INS.OPTI4.NAME	see Table 7	1x12.6	VIS slit
INS.OPTI5.NAME	see Table 8	1x12.6	NIR slit
SEQ.AGSNAPSHOT	T, F	F	Acquisition image before science exposures?

XSHOOTER_ifu_obs_GenericOffset			
<i>Keyword</i>	<i>Range</i>	<i>Default Value</i>	<i>Label</i>
<i>Free parameters</i>			
DET1.WIN1.UIT1	0..36000		UVB exposure time (s)
DET1.READ.CLKDESCR	see Table 5	100k/1pt/hg	UVB readout mode
DET2.WIN1.UIT1	0..36000		VIS exposure time (s)
DET2.READ.CLKDESCR	see Table 5	100k/1pt/hg	VIS readout mode
DET3.DIT	0..36000		NIR Detector Integration Time (s)
DET3.NDIT	1..20	1	number of DITs
SEQ.NEXP.UVB	0..100	1	UVB number of exposures per offset position
SEQ.NEXP.VIS	0..100	1	VIS number of exposures per offset position
SEQ.NEXP.NIR	0..100	1	NIR number of exposures per offset position
SEQ.OFFSET.COORDS	SKY, SLIT	SKY	Offset coordinate type RA/DEC or X/Y
SEQ.RELOFF1	-1000..1000	0	List of RA/X offsets (")
SEQ.RELOFF2	-1000..1000	0	List of DEC/Y offsets (")
SEQ.OBS.TYPE	O,S	O S	List of observation type (object or sky)
SEQ.NOFFSET	0..100	2	Number of offsets
SEQ.OFFSET.ZERO	T, F	T	Return to Origin?
<i>Fixed Values</i>			
INS.MODE	SLITSPEC, IFUSPEC	IFUSPEC	Instrument Mode
INS.OPTI3.NAME	see Table 4	1x12.6	UVB Slit slide



INS.OPTI4.NAME	see Table 7	1x12.6	VIS Slit slide
INS.OPTI5.NAME	see Table 8	1x12.6	NIR Slit slide
SEQ.AGSNAPSHOT	T,F	F	Acquisition image before science exposures?

5.1.5 Night-time calibration templates

5.1.5.1 Spectrophotometric standard stars

XSHOOTER_slit_cal_SpecphotStdStare			
<i>Keyword</i>	<i>Range</i>	<i>Default Value</i>	<i>Label</i>
<i>Free parameters</i>			
INS.OPTI3.NAME	see Table 4	5.0x11	UVB slit
INS.OPTI4.NAME	see Table 7	5.0x11	VIS slit
INS.OPTI5.NAME	see Table 8	5.0x11	NIR slit
DET1.WIN1.UIT1	0..36000		UVB exposure time (s)
DET1.READ.CLKDESCR	see Table 5	100k/1pt/hg	UVB readout mode
DET2.WIN1.UIT1	0..36000		VIS exposure time (s)
DET2.READ.CLKDESCR	see Table 5	100k/1pt/hg	VIS readout mode
DET3.DIT	0..36000		NIR Detector Integration Time (s)
DET3.NDIT	1..20	1	number of DITs
SEQ.NEXPO.UVB	0..100	1	UVB number of exposures
SEQ.NEXPO.VIS	0..100	1	VIS number of exposures
SEQ.NEXPO.NIR	0..100	1	NIR number of exposures
<i>Fixed Values</i>			
INS.MODE	SLITSPEC, IFUSPEC	SLITSPEC	Instrument Mode
SEQ.AGSNAPSHOT	T, F	F	Acquisition image before science exposures?

XSHOOTER_slit_cal_SpecphotStdOffset			
<i>Keyword</i>	<i>Range</i>	<i>Default Value</i>	<i>Label</i>
<i>Free parameters</i>			
INS.OPTI3.NAME	see Table 4	5.0x11	UVB slit
INS.OPTI4.NAME	see Table 7	5.0x11	VIS slit
INS.OPTI5.NAME	see Table 8	5.0x11	NIR slit
DET1.WIN1.UIT1	0..36000		UVB exposure time (s)
DET1.READ.CLKDESCR	see Table 5	100k/1pt/hg	UVB readout mode
DET2.WIN1.UIT1	0..36000		VIS exposure time (s)
DET2.READ.CLKDESCR	see Table 5	100k/1pt/hg	VIS readout mode
DET3.DIT	0..36000		NIR Detector Integration Time (s)
DET3.NDIT	1..20	1	number of DITs
SEQ.NEXP.UVB	0..100	1	UVB number of exposures per offset position



SEQ.NEXP.VIS	0..100	1	VIS number of exposures per offset position
SEQ.NEXP.NIR	0..100	1	NIR number of exposures per offset position
SEQ.FIXOFF.RA	-100..100	0	RA fixed offset (")
SEQ.FIXOFF.DEC	-100..100	0	DEC fixed offset (")
SEQ.JITTER.WIDTH	0..2	0	Jitter box width in "
SEQ.NABCYCLES	0..100	1	Number OS or SO cycles
SEQ.OFFSET.ZERO	T, F	T	Return to Origin?
<i>Fixed Values</i>			
INS.MODE	SLITSPEC, IFUSPEC	SLITSPEC	Instrument Mode
SEQ.AGSNAPSHOT	T, F	F	Acquisition image before science exposures?

XSHOOTER_slit_cal_SpecphotNodding			
<i>Keyword</i>	<i>Range</i>	<i>Default Value</i>	<i>Label</i>
<i>Free parameters</i>			
INS.OPTI3.NAME	see Table 4	5.0"x11"	UVB slit
INS.OPTI4.NAME	see Table 7	5.0"x11"	VIS slit
INS.OPTI5.NAME	see Table 8	5.0"x11"	NIR slit
DET1.WIN1.UIT1	0..36000		UVB exposure time (s)
DET1.READ.CLKDESCR	see Table 5	100k/1pt/hg	UVB readout mode
DET2.WIN1.UIT1	0..36000		VIS exposure time (s)
DET2.READ.CLKDESCR	see Table 5	100k/1pt/hg	VIS readout mode
DET3.DIT	0..36000		NIR Detector Integration Time (s)
DET3.NDIT	1..20	1	number of DITs
SEQ.NEXP.UVB	0..100	1	UVB number of exposures per offset position
SEQ.NEXP.VIS	0..100	1	VIS number of exposures per offset position
SEQ.NEXP.NIR	0..100	1	NIR number of exposures per offset position
SEQ.SKYTHROW	0..10	5	Nod Throw in "
SEQ.JITTER.WIDTH	0..2	0	Jitter box width in "
SEQ.NABCYCLES	0..100	1	Number AB or BA cycles
SEQ.OFFSET.ZERO	T, F	T	Return to Origin?
<i>Fixed Values</i>			
INS.MODE	SLITSPEC, IFUSPEC	SLITSPEC	Instrument Mode
SEQ.AGSNAPSHOT	T, F	F	Acquisition image before science exposures?

XSHOOTER_ifu_cal_SpecphotStdStare			
<i>Keyword</i>	<i>Range</i>	<i>Default Value</i>	<i>Label</i>



<i>Free parameters</i>			
DET1.WIN1.UIT1	0..36000		UVB exposure time (s)
DET1.READ.CLKDESCR	see Table 5	100k/1pt/hg	UVB readout mode
DET2.WIN1.UIT1	0..36000		VIS exposure time (s)
DET2.READ.CLKDESCR	see Table 5	100k/1pt/hg	VIS readout mode
DET3.DIT	0..36000		NIR Detector Integration Time (s)
DET3.NDIT	1..20	1	number of DITs
SEQ.NEXP.UVB	0..100	1	UVB number of exposures
SEQ.NEXP.VIS	0..100	1	VIS number of exposures
SEQ.NEXP.NIR	0..100	1	NIR number of exposures
<i>Fixed Values</i>			
INS.MODE	SLITSPEC,IFUSPEC	IFUSPEC	Instrument Mode
INS.OPTI3.NAME	see Table 4	1x12.6	UVB slit
INS.OPTI4.NAME	See Table 7	1x12.6	VIS slit
INS.OPTI5.NAME	see Table 8	1x12.6	NIR slit
SEQ.AGSNAPSHOT	T, F	F	Acquisition image before science exposures?

XSHOOTER_ifu_cal_SpecphotStdOffset			
<i>Keyword</i>	<i>Range</i>	<i>Default Value</i>	<i>Label</i>
<i>Free parameters</i>			
DET1.WIN1.UIT1	0..36000		UVB exposure time (s)
DET1.READ.CLKDESCR	see Table 5	100k/1pt/hg	UVB read-out mode
DET2.WIN1.UIT1	0..36000		VIS exposure time (s)
DET2.READ.CLKDESCR	see Table 5	100k/1pt/hg	VIS read-out mode
DET3.DIT	0..36000		NIR Detector Integration Time (s)
DET3.NDIT	1..20	1	number of DITs
SEQ.NEXP.UVB	0..100	1	UVB number of exposures per offset position
SEQ.NEXP.VIS	0..100	1	VIS number of exposures per offset position
SEQ.NEXP.NIR	0..100	1	NIR number of exposures per offset position
SEQ.FIXOFF.RA	-100..100	0	RA fixed offset (")
SEQ.FIXOFF.DEC	-100..100	0	DEC fixed offset (")
SEQ.JITTER.WIDTH	0..2	0	Jitter box width in "
SEQ.NABCYCLES	0..100	1	Number OS or SO cycles
SEQ.OFFSET.ZERO	T, F	T	Return to Origin?
<i>Fixed Values</i>			
INS.MODE	SLITSPEC,IFUSPEC	IFUSPEC	Instrument Mode
INS.OPTI3.NAME	see Table 4	1x12.6	UVB slit
INS.OPTI4.NAME	see Table 7	1x12.6	VIS slit
INS.OPTI5.NAME	see Table 8	1x12.6	NIR slit
SEQ.AGSNAPSHOT	T, F	F	Acquisition image before science exposures?



5.1.5.2 Telluric standard stars

XSHOOTER_slit_cal_TelluricStdStare			
<i>Keyword</i>	<i>Range</i>	<i>Default Value</i>	<i>Label</i>
<i>Free parameters</i>			
INS.OPTI3.NAME	see Table 4	1.0x11	UVB slit
INS.OPTI4.NAME	see Table 7	0.9x11	VIS slit
INS.OPTI5.NAME	see Table 8	0.9x11	NIR slit
DET1.WIN1.UIT1	0..36000		UVB exposure time (s)
DET1.READ.CLKDESCR	see Table 5	100k/1pt/hg	UVB readout mode
DET2.WIN1.UIT1	0..36000		VIS exposure time (s)
DET2.READ.CLKDESCR	see Table 5	100k/1pt/hg	VIS readout mode
DET3.DIT	0..36000		NIR Detector Integration Time (s)
DET3.NDIT	1..20	1	number of DITs
SEQ.NEXPO.UVB	0..100	1	UVB number of exposures
SEQ.NEXPO.VIS	0..100	1	VIS number of exposures
SEQ.NEXPO.NIR	0..100	1	NIR number of exposures
<i>Fixed Values</i>			
INS.MODE	IFUSPEC,SLITSPEC	SLITSPEC	Instrument Mode
SEQ.AGSNAPSHOT	T, F	F	Acquisition image before science exposures?

XSHOOTER_slit_cal_TelluricStdNod			
<i>Keyword</i>	<i>Range</i>	<i>Default Value</i>	<i>Label</i>
<i>Free parameters</i>			
INS.OPTI3.NAME	see Table 4	1.0x11	UVB slit
INS.OPTI4.NAME	see Table 7	0.9x11	VIS slit
INS.OPTI5.NAME	see Table 8	0.9x11	NIR slit
DET1.WIN1.UIT1	0..36000		UVB exposure time (s)
DET1.READ.CLKDESCR	see Table 5	100k/1pt/hg	UVB readout mode
DET2.WIN1.UIT1	0..36000		VIS exposure time (s)
DET2.READ.CLKDESCR	see Table 5	100k/1pt/hg	VIS readout mode
DET3.DIT	0..36000		NIR Detector Integration Time (s)
DET3.NDIT	1..9999	1	Number of DITs
SEQ.NEXP.UVB	0..100	1	UVB number of exposures per offset position
SEQ.NEXP.VIS	0..100	1	VIS number of exposures per offset position
SEQ.NEXP.NIR	0..100	1	NIR number of exposures per offset position
SEQ.SKYTHROW	0..10	5	Nod Throw in “
SEQ.JITTER.WIDTH	0..2	0	Jitter box width in “
SEQ.NABCYCLES	0..100	1	Number AB or BA cycles
SEQ.OFFSET.ZERO	T, F	T	Return to Origin?
<i>Fixed Values</i>			



INS.MODE	IFUSPEC,SLITSPEC	SLITSPEC	Instrument Mode
SEQ.AGSNAPSHOT	T, F	F	Acquisition image before science exposures?

XSHOOTER_ifu_cal_TelluricStdStare			
<i>Keyword</i>	<i>Range</i>	<i>Default Value</i>	<i>Label</i>
<i>Free parameters</i>			
DET1.WIN1.UIT1	0..36000		UVB exposure time (s)
DET1.READ.CLKDESCR	see Table 5	100k/1pt/hg	UVB readout mode
DET2.WIN1.UIT1	0..36000		VIS exposure time (s)
DET2.READ.CLKDESCR	see Table 5	100k/1pt/hg	VIS readout mode
DET3.DIT	0..36000		NIR Detector Integration Time (s)
DET3.NDIT	1..20	1	number of DITs
SEQ.NEXP.UVB	0..100	1	UVB number of exposures
SEQ.NEXP.VIS	0..100	1	VIS number of exposures
SEQ.NEXP.NIR	0..100	1	NIR number of exposures
<i>Fixed Values</i>			
INS.MODE	IFUSPEC,SLITSPEC	IFUSPEC	Instrument Mode
INS.OPTI3.NAME	see Table 4	1x12.6	UVB slit
INS.OPTI4.NAME	see Table 7	1x12.6	VIS slit
INS.OPTI5.NAME	see Table 8	1x12.6	NIR slit
SEQ.AGSNAPSHOT	T, F	F	Acquisition image before science exposures?

XSHOOTER_ifu_cal_TelluricStdOffset			
<i>Keyword</i>	<i>Range</i>	<i>Default Value</i>	<i>Label</i>
<i>Free parameters</i>			
DET1.WIN1.UIT1	0..36000		UVB Exposure Time (s)
DET1.READ.CLKDESCR	see Table 5	100k/1pt/hg	UVB read-out mode
DET2.WIN1.UIT1	0..36000		VIS Exposure Time (s)
DET2.READ.CLKDESCR	see Table 5	100k/1pt/hg	VIS read-out mode
DET3.DIT	0..36000		NIR Detector Integration Time (s)
DET3.NDIT	1..20	1	number of DITs
SEQ.NEXP.UVB	0..100	1	UVB number of exposures per offset position
SEQ.NEXP.VIS	0..100	1	VIS number of exposure per offset position
SEQ.NEXP.NIR	0..100	1	NIR number of exposure per offset position
SEQ.FIXOFF.RA	-100..100	0	RA fixed offset (arcsec)
SEQ.FIXOFF.DEC	-100..100	0	DEC fixed offset (arcsec)
SEQ.JITTER.WIDTH	0..2	0	Jitter box width in arcsec
SEQ.NABCYCLES	0..100	1	Number OS or SO cycles
SEQ.OFFSET.ZERO	T, F	T	Return to Origin?



<i>Fixed Values</i>			
INS.MODE	IFUSPEC,SLITSPEC	IFUSPEC	Instrument Mode
INS.OPTI3.NAME	see Table 4	1x12.6	UVB slit
INS.OPTI4.NAME	see Table 7	1x12.6	VIS slit
INS.OPTI5.NAME	see Table 8	1x12.6	NIR slit
SEQ.AGSNAPSHOT	T, F	F	Acquisition image before science exposures?

5.1.5.3 Attached night-time calibrations

These must be taken after the science template in order to have the correct instrument setup.

XSHOOTER_slit_cal_UVBVisArcsAtt			
<i>Keyword</i>	<i>Range</i>	<i>Default Value</i>	<i>Label</i>
<i>Free Parameters</i>			
DET1.WIN1.UIT1	0..36000		UVB exposure time
DET1.READ.CLKDESCR	see Table 5	400/1pt/lg	UVB readout mode
DET2.WIN1.UIT1	0..36000		VIS exposure time
DET2.READ.CLKDESCR	see Table 5	400/1pt/lg	VIS readout mode
SEQ.NEXPO.UVB	0..100	1	No. of UVB exposures
SEQ.NEXPO.VIS	0..100	1	No. of VIS exposures
<i>Fixed Value</i>			
INS.MODE	IFUSPEC,SLITSPEC	SLITSPEC	Instrument Mode

XSHOOTER_slit_cal_UVBLampFlatAtt			
<i>Keyword</i>	<i>Range</i>	<i>Default Value</i>	<i>Label</i>
<i>Free Parameters</i>			
DET1.WIN1.UIT1.HIGHF	0..36000		UVB exposure time (High Flat)
DET1.WIN1.UIT1.LOWF	0..36000		UVB exposure time (Low Flat)
DET2.READ.CLKDESCR	see Table 5		VIS readout mode
SEQ.NEXPO.HIGHF	0..100		No. of exposures (High Flat)
SEQ.NEXPO.LOWF	0..100		No. of exposures (Low Flat)
<i>Fixed Value</i>			
INS.MODE	IFUSPEC,SLITSPEC	SLITSPEC	Instrument Mode

XSHOOTER_slit_cal_VISLampFlatAtt			
<i>Keyword</i>	<i>Range</i>	<i>Default Value</i>	<i>Label</i>
<i>Free Parameters</i>			
DET2.WIN1.UIT1	0..36000		VIS exposure time
DET2.READ.CLKDESCR	see Table 5		VIS readout mode
SEQ.NEXPO	0..100		No. of exposures
<i>Fixed Value</i>			
INS.MODE	IFUSPEC,SLITSPEC	SLITSPEC	Instrument Mode

XSHOOTER_slit_cal_NIRLampFlatAtt			
<i>Keyword</i>	<i>Range</i>	<i>Default Value</i>	<i>Label</i>



<i>Free Parameters</i>			
DET3.DIT	0..36000		NIR exposure time (DIT)
DET3.NDIT	0..20		No. of NIR sub-integrations
SEQ.NEXPO	0..100		No. of exposures
<i>Fixed Value</i>			
INS.MODE	IFUSPEC,SLITSPEC	SLITSPEC	Instrument Mode

XSHOOTER_ifu_cal_UVBVisArcsAtt			
<i>Keyword</i>	<i>Range</i>	<i>Default Value</i>	<i>Label</i>
<i>Free Parameters</i>			
DET1.WIN1.UIT1	0..36000		UVB exposure time
DET1.READ.CLKDESCR	see Table 5		UVB readout mode
DET2.WIN1.UIT1	0..36000		VIS exposure time
DET2.READ.CLKDESCR	see Table 5		VIS readout mode
SEQ.NEXPO.UVB	0..100	1	No. of UVB exposures
SEQ.NEXPO.VIS	0..100	1	No. of VIS exposures
<i>Fixed Value</i>			
INS.MODE	IFUSPEC,SLITSPEC	IFUSPEC	Instrument Mode

XSHOOTER_ifu_cal_UVBLampFlatAtt			
<i>Keyword</i>	<i>Range</i>	<i>Default Value</i>	<i>Label</i>
<i>Free Parameters</i>			
DET1.WIN1.UIT1.HIGHF	0..36000		UVB exposure time (High Flat)
DET1.WIN1.UIT1.LOWF	0..36000		UVB exposure time (Low Flat)
DET2.READ.CLKDESCR	see Table 5		VIS readout mode
SEQ.NEXPO.HIGHF	0..100		No. of exposures (High Flat)
SEQ.NEXPO.LOWF	0..100		No. of exposures (Low Flat)
<i>Fixed Value</i>			
INS.MODE	IFUSPEC,SLITSPEC	IFUSPEC	Instrument Mode

XSHOOTER_ifu_cal_VISLampFlatAtt			
<i>Keyword</i>	<i>Range</i>	<i>Default Value</i>	<i>Label</i>
<i>Free Parameters</i>			
DET2.WIN1.UIT1	0..36000		VIS exposure time
DET2.READ.CLKDESCR	see Table 5		VIS readout mode
SEQ.NEXPO	0..100		No. of exposures
<i>Fixed Value</i>			
INS.MODE	IFUSPEC,SLITSPEC	IFUSPEC	Instrument Mode

XSHOOTER_ifu_cal_NIRLampFlatAtt			
<i>Keyword</i>	<i>Range</i>	<i>Default Value</i>	<i>Label</i>
<i>Free Parameters</i>			
DET3.DIT	0..36000	60	NIR exposure time (DIT)



DET3.NDIT	0..20	1	No. of NIR sub-integrations
SEQ.NEXPO	0..100		No. of exposures
<i>Fixed Value</i>			
INS.MODE	IFUSPEC,SLITSPEC	IFUSPEC	Instrument Mode

To insure a better wavelength calibration, one can attach ARC+multipinhole templates. They do not need to be executed after a science template, because they configure the instrument. These are used for the 2d wave maps (wavelength calibration).

XSHOOTER_slit_cal_UVBVisArcsMultiplePinhole			
<i>Keyword</i>	<i>Range</i>	<i>Default Value</i>	<i>Label</i>
<i>Free parameters</i>			
DET1.WIN1.UIT1	0..36000	15	UVB Exposure Time (s)
DET1.READ.CLKDESCR	see Table 5	400k/1pt/lg	UVB read-out mode
DET2.WIN1.UIT1	0..36000	10	VIS Exposure Time (s)
DET2.READ.CLKDESCR	see Table 5	400k/1pt/lg	VIS read-out mode
SEQ.NEXP.UVB	0..100	1	UVB number of exposures per offset position
SEQ.NEXP.VIS	0..100	1	VIS number of exposure per offset position
<i>Fixed Values</i>			
INS.MODE	IFUSPEC,SLITSPEC	SLITSPEC	Instrument Mode
INS.OPTI3.NAME	see Table 4	Pin_row	UVB slit
INS.OPTI4.NAME	see Table 7	Pin_row	VIS slit

XSHOOTER_slit_cal_NIRArcsMultiplePinhole			
<i>Keyword</i>	<i>Range</i>	<i>Default Value</i>	<i>Label</i>
<i>Free parameters</i>			
DET3.DIT	0..36000	5	NIR Detector Integration Time (s)
DET3.NDIT	1..20	10	number of DITs
SEQ.NEXP.NIR	0..100	1	NIR number of exposure per offset position
<i>Fixed Values</i>			
INS.MODE	IFUSPEC,SLITSPEC	SLITSPEC	Instrument Mode
INS.OPTI5.NAME	see Table 8	Pin_row	NIR slit

5.1.6 Daytime calibration templates

5.1.6.1 SLT and IFU arcs (resolution, tilt)

XSHOOTER_slit_cal_UVBVisArcs			
<i>Free Parameters</i>			
<i>Keyword</i>	<i>Range</i>	<i>Default Value</i>	<i>Label</i>
<i>Free Parameters</i>			
INS.OPTI3.NAME	see Table 4	1.0x11	UVB slit
INS.OPTI4.NAME	see Table 7	0.9x11	VIS slit
DET1.WIN1.UIT1	0..36000	30	UVB exposure time
DET1.READ.CLKDESCR	see Table 5	400/1pt/lg	UVB readout mode



DET2.WIN1.UIT1	0..36000	5	VIS exposure time
DET2.READ.CLKDESCR	see Table 5	400/1pt/lg	VIS readout mode
SEQ.NEXPO.UVB	0..100	1	No. of UVB exposures
SEQ.NEXPO.VIS	0..100	1	No. of VIS exposures
<i>Fixed Values</i>			
INS.MODE	SLITSPEC,IFUSPEC	SLITSPEC	Instrument Mode

XSHOOTER_slit_cal_NIRArcs			
<i>Free Parameters</i>			
<i>Keyword</i>	<i>Range</i>	<i>Default Value</i>	<i>Label</i>
INS.OPTI5.NAME	see Table 8	0.9x11	NIR Slit slide
DET3.DIT	0..36000	0.66	NIR Exposure Time
DET3.NDIT	1..20	1	Number of DITs
SEQ.NEXPO	0..100	1	No. of NIR exposures
<i>Fixed Values</i>			
INS.MODE	SLITSPEC,IFUSPEC	SLITSPEC	Instrument Mode

XSHOOTER_ifu_cal_UVBVisArcs			
<i>Free Parameters</i>			
<i>Keyword</i>	<i>Range</i>	<i>Default Value</i>	<i>Label</i>
DET1.WIN1.UIT1	0..36000	45	UVB Exposure Time
DET1.READ.CLKDESCR	see Table 5	400k/1pt/lg	UVB readout mode
DET2.WIN1.UIT1	0..36000	4	VIS Exposure Time
DET2.READ.CLKDESCR	see Table 5	400k/1pt/lg	VIS readout mode
SEQ.NEXPO.UVB	0..100	1	No. of UVB exposures
SEQ.NEXPO.VIS	0..100	1	No. of VIS exposures
<i>Fixed Values</i>			
INS.MODE	IFUSPEC,SLITSPEC	IFUSPEC	Instrument Mode
INS.OPTI3.NAME	see Table 4	1.0x12.6	UVB slit
INS.OPTI4.NAME	see Table 7	1.0x12.6	VIS slit

XSHOOTER_ifu_cal_NIRArcs			
<i>Free Parameters</i>			
<i>Keyword</i>	<i>Range</i>	<i>Default Value</i>	<i>Label</i>
DET3.DIT	0..36000	1.32	NIR Exposure Time
DET3.NDIT	1..20	1	Number of DITs
SEQ.NEXPO	0..100	1	No. of NIR exposures
<i>Fixed Values</i>			
INS.MODE	IFUSPEC,SLITSPEC	IFUSPEC	Instrument Mode
INS.OPTI5.NAME	see Table 8	1.0x12.6	NIR slit

5.1.6.2 Flatfield (pixel response, orders localization)

XSHOOTER_slit_cal_UVBLampFlat			
<i>Free Parameters</i>			
<i>Keyword</i>	<i>Range</i>	<i>Default Value</i>	<i>Label</i>
INS.OPTI3.NAME	see Table 4	1.0x11	UVB slit
DET1.READ.CLKDESCR	see Table 5	100k/1pt/hg	UVB readout mode



DET1.WIN1.UIT1.HIGHF	0..36000	7.4	Halogen lamp exposure time
DET1.WIN1.UIT1.LOWF	0..36000	2.8	D ₂ lamp exposure time
SEQ.NEXPO.HIGHF	0..100	5	Number of Halogen lamp exp
SEQ.NEXPO.LOWF	0..100	5	Number of D ₂ lamp exp.
<i>Fixed Values</i>			
INS.MODE	SLITSPEC,IFUSPEC	SLITSPEC	Instrument Mode

XSHOOTER_slit_cal_VISLampFlat			
<i>Free Parameters</i>			
<i>Keyword</i>	<i>Range</i>	<i>Default Value</i>	<i>Label</i>
INS.OPTI4.NAME	see Table 4	0.9x11	VIS slit
DET2.WIN1.UIT1	0..36000	8	VIS Exposure Time
DET2.READ.CLKDESCR	see Table 5	100k/1pt/hg	VIS readout mode
SEQ.NEXPO	0..100	5	VIS # of exposure
<i>Fixed Values</i>			
INS.MODE	SLITSPEC,IFUSPEC	SLITSPEC	Instrument Mode

XSHOOTER_slit_cal_NIRLampFlat			
<i>Free Parameters</i>			
<i>Keyword</i>	<i>Range</i>	<i>Default Value</i>	<i>Label</i>
INS.OPTI5.NAME	see Table 8	0.9x11	NIR slit
DET3.DIT	0..36000	40	NIR exposure time
DET3.NDIT	1..20	1	Number of DITs
SEQ.NEXPO	0..100	5	NIR No. of exposure
<i>Fixed Values</i>			
INS.MODE	SLITSPEC,IFUSPEC	SLITSPEC	Instrument Mode

XSHOOTER_ifu_cal_UVBLampFlat			
<i>Free Parameters</i>			
<i>Keyword</i>	<i>Range</i>	<i>Default Value</i>	<i>Label</i>
DET1.READ.CLKDESCR	see Table 5	100k/1pt/hg	UVB readout mode
DET1.WIN1.UIT1.HIGHF	0..36000	12.3	Halo. lamp exposure time
DET1.WIN1.UIT1.LOWF	0..36000	4.7	D ₂ lamp exposure time
SEQ.NEXPO.HIGHF	0..100	5	Number of Halo. lamp exp
SEQ.NEXPO.LOWF	0..100	5	Number of D ₂ lamp exp.
<i>Fixed Values</i>			
INS.MODE	IFUSPEC,SLITSPEC	IFUSPEC	Instrument Mode
INS.OPTI3.NAME	see Table 4	1.0x12.6	UVB slit

XSHOOTER_ifu_cal_VISLampFlat			
<i>Free Parameters</i>			
<i>Keyword</i>	<i>Range</i>	<i>Default Value</i>	<i>Label</i>



DET2.WIN1.UIT1	0..36000	12.2	VIS Exposure Time
DET2.READ.CLKDESCR	see Table 5	100k/1pt/hg	VIS readout mode
SEQ.NEXPO	0..100	5	VIS No. of exposure
<i>Fixed Values</i>			
INS.MODE	IFUSPEC,SLITSPEC	IFUSPEC	Instrument Mode
INS.OPTI4.NAME	see Table 7	1.0x12.6	VIS slit

XSHOOTER_ifu_cal_NIRLampFlat			
<i>Free Parameters</i>			
<i>Keyword</i>	<i>Range</i>	<i>Default Value</i>	<i>Label</i>
DET3.DIT	0..36000	60	NIR exposure time
DET3.NDIT	1..20	1	Number of DITs
SEQ.NEXPO	0..100	5	NIR No. of exposures
<i>Fixed Values</i>			
INS.MODE	IFUSPEC,SLITSPEC	IFUSPEC	Instrument Mode
INS.OPTI5.NAME	see Table 8	1.0x12.6	NIR slit

5.1.6.3 Format check (1st guess of wavelength solution)

XSHOOTER_slit_cal_UVBVisArcsSinglePinhole			
<i>Free Parameters</i>			
<i>Keyword</i>	<i>Range</i>	<i>Default Value</i>	<i>Label</i>
DET1.WIN1.UIT1	0..36000	40	UVB Exposure Time
DET1.READ.CLKDESCR	see Table 5	400k/1pt/lg	UVB readout mode
DET2.WIN1.UIT1	0..36000	15	VIS Exposure Time
DET2.READ.CLKDESCR	see Table 5	400k/1pt/lg	VIS readout mode
SEQ.NEXPO.UVB	0..100	1	No. of UVB exposures
SEQ.NEXPO.VIS	0..100	1	No. of VIS exposures
<i>Fixed Values</i>			
INS.MODE	SLITSPEC,IFUSPEC	SLITSPEC	Instrument Mode
INS.OPTI3.NAME	see Table 4	Pin_0.5	UVB slit
INS.OPTI4.NAME	see Table 7	Pin_0.5	VIS slit

XSHOOTER_slit_cal_NIRArcsSinglePinhole			
<i>Free Parameters</i>			
<i>Keyword</i>	<i>Range</i>	<i>Default Value</i>	<i>Label</i>
DET3.DIT	0..36000	10	NIR Exposure Time
DET3.NDIT	1..20	5	Number of DITs
SEQ.NEXPO	0..100	1	NIR # of exposure
<i>Fixed Values</i>			
INS.MODE	SLITSPEC,IFUSPEC	SLITSPEC	Instrument Mode
INS.OPTI5.NAME	see Table 8	Pin_0.5	NIR slit

5.1.6.4 Order definition (1st guess of order localization)

XSHOOTER_slit_cal_UVBLampFlatSinglePinhole			
<i>Free Parameters</i>			
<i>Keyword</i>	<i>Range</i>	<i>Default Value</i>	<i>Label</i>



DET1.WIN1.UIT1.HIGHF	0..36000	30	UVB exposure time (High Flat)
DET1.WIN1.UIT1.LOWF	0..36000	20	UVB exposure time (Low Flat)
DET1.READ.CLKDESCR	see Table 5	400k/1pt/lg	UVB readout mode
SEQ.NEXPO.HIGHF	0..30	1	No. of exposures (High Flat)
SEQ.NEXPO.LOWF	0..30	1	No. of exposures (Low Flat)
<i>Fixed Values</i>			
INS.MODE	SLITSPEC,IFUSPEC	SLITSPEC	Instrument Mode
INS.OPTI3.NAME	see Table 8	Pin_0.5	UVB Slit slide

XSHOOTER_slit_cal_VISLampFlatSinglePinhole			
<i>Free Parameters</i>			
<i>Keyword</i>	<i>Range</i>	<i>Default Value</i>	<i>Label</i>
DET2.WIN1.UIT1	0..36000	60	VIS exposure time
DET2.READ.CLKDESCR	see Table 5	400k/1pt/lg	VIS readout mode
SEQ.NEXPO	0..100	1	No. of exposures
<i>Fixed Values</i>			
INS.MODE	SLITSPEC,IFUSPEC	SLITSPEC	Instrument Mode
INS.OPTI4.NAME	see Table 7	Pin_0.5	VIS slit

XSHOOTER_slit_cal_NIRLampFlatSinglePinhole.			
<i>Free Parameters</i>			
<i>Keyword</i>	<i>Range</i>	<i>Default Value</i>	<i>Label</i>
DET3.DIT	0..36000	1	NIR exposure time
DET3.NDIT	1..20	1	Number of DITs
SEQ.NEXPO	0..100	1	NIR No. of exposures
<i>Fixed Values</i>			
INS.MODE	SLITSPEC,IFUSPEC	SLITSPEC	Instrument Mode
INS.OPTI5.NAME	see Table 8	Pin_0.5	NIR Slit slide

5.1.6.5 Multi-pinhole arcs

XSHOOTER_slit_cal_UVBVisArcsMultiplePinhole			
<i>Free Parameters</i>			
<i>Keyword</i>	<i>Range</i>	<i>Default Value</i>	<i>Label</i>
DET1.WIN1.UIT1	0..36000	15	UVB exposure time
DET1.READ.CLKDESCR	see Table 5	400k/1pt/lg	UVB readout mode
DET2.WIN1.UIT1	0..36000	10	VIS exposure time
DET2.READ.CLKDESCR	see Table 5	400k/1pt/lg	VIS readout mode
SEQ.NEXPO.UVB	0..100	1	UVB No. of exposure
SEQ.NEXPO.VIS	0..100	1	VIS No. of exposure
<i>Fixed Values</i>			
INS.MODE	SLITSPEC,IFUSPEC	SLITSPEC	Instrument Mode
INS.OPTI3.NAME	see Table 4	Pin_row	UVB Slit slide
INS.OPTI4.NAME	see Table 7	Pin_row	VIS Slit slide



XSHOOTER_slit_cal_NIRArcsMultiplePinhole			
<i>Free Parameters</i>			
<i>Keyword</i>	<i>Range</i>	<i>Default Value</i>	<i>Label</i>
DET3.DIT	0..36000	5	NIR exposure time
DET3.NDIT	1..20	10	Number of DITs
SEQ.NEXPO	0..100	1	NIR No. of exposures
<i>Fixed Values</i>			
INS.MODE	SLITSPEC,IFUSPEC	SLITSPEC	Instrument Mode
INS.OPTI5.NAME	see Table 8	Pin_row	NIR Slit wheel

5.1.6.6 Detector calibrations

XSHOOTER_gen_cal_Bias			
<i>Free Parameters</i>			
<i>Keyword</i>	<i>Range</i>	<i>Default Value</i>	<i>Label</i>
DET1.READ.CLKDESCR	see Table 5	100k/1pt/hg	UVB read-out mode
DET2.READ.CLKDESCR	see Table 5	100k/1pt/hg	VIS read-out mode
SEQ.NEXPO.UVB	0..100	1	UVB No. of exposures
SEQ.NEXPO.VIS	0..100	1	VIS No. of exposure
<i>Fixed Values</i>			
DET1.WIN1.UIT1		0	UVB exposure time
DET2.WIN1.UIT1		0	VIS exposure time

XSHOOTER_gen_cal_DarkUVBVis			
<i>Free Parameters</i>			
<i>Keyword</i>	<i>Range</i>	<i>Default Value</i>	<i>Label</i>
DET1.WIN1.UIT1	0..36000	3600	UVB Exposure Time
DET1.READ.CLKDESCR	see Table 5	100k/1pt/hg	UVB read-out mode
DET2.WIN1.UIT1	0..36000	3600	VIS Exposure Time
DET2.READ.CLKDESCR	see Table 5	100k/1pt/hg	VIS read-out mode
SEQ.NEXPO.UVB	0..100	1	UVB No. of exposures
SEQ.NEXPO.VIS	0..100	1	VIS No. of exposures
<i>Fixed Values</i>			

XSHOOTER_gen_cal_DarkNIR			
<i>Free Parameters</i>			
<i>Keyword</i>	<i>Range</i>	<i>Default Value</i>	<i>Label</i>
DET3.DIT	0..36000		NIR Exposure Time
DET3.NDIT	1..20	1	Number of DITs
SEQ.NEXPO	0..100	3	No. of NIR exposures
<i>Fixed Values</i>			

XSHOOTER_gen_cal_DarkUVBVis			
<i>Keyword</i>	<i>Range</i>	<i>Default Value</i>	<i>Label</i>
<i>Free parameters</i>			
DET1.WIN1.UIT1	0..36000	3600	UVB exposure time (s)
DET1.READ.CLKDESCR	see Table 5	100k/1pt/hg	UVB readout mode



DET2.WIN1.UIT1	0..36000	3600	VIS exposure time (s)
DET2.READ.CLKDESCR	see Table 5	100k/1pt/hg	VIS readout mode
SEQ.NEXPO.UVB	0..100	1	UVB number of exposures
SEQ.NEXPO.VIS	0..100	1	VIS number of exposures
<i>Fixed Values</i>			

XSHOOTER_slit_cal MultipleOrderDef			
<i>Keyword</i>	<i>Range</i>	<i>Default Value</i>	<i>Label</i>
<i>Free parameters</i>			
DET1.WIN1.UIT1.HIGHF	0..36000	30	UVB exposure time (s)
DET1.WIN1.UIT1.LOWF	0..36000	20	UVB exposure time (s)
DET1.READ.CLKDESCR	see Table 5	400k/1pt/lg	UVB read-out mode
DET2.WIN1.UIT1	0..36000	60	VIS exposure time (s)
DET2.READ.CLKDESCR	see Table 5	400k/1pt/lg	VIS read-out mode
DET3.DIT	0..36000	20	NIR Detector Integration Time (s)
DET3.NDIT	1..20	1	number of DITs
SEQ.NEXP.UVB.HIGHF	0..100	1	UVB number of exposures
SEQ.NEXP.UVB.LOWF	0..100	1	UVB number of exposures
SEQ.NEXP.VIS	0..100	1	VIS number of exposures
SEQ.NEXP.NIR	0..100	1	NIR number of exposures
<i>Fixed Values</i>			
INS.MODE	SLITSPEC,IFUSPEC	SLITSPEC	Instrument Mode
INS.OPTI3.NAME	see Table 4	Pin_row	UVB slit
INS.OPTI4.NAME	see Table 7	Pin_row	VIS slit
INS.OPTI5.NAME	see Table 8	Pin_row	NIR slit

XSHOOTER_gen_cal CCDFlat			
<i>Keyword</i>	<i>Range</i>	<i>Default Value</i>	<i>Label</i>
<i>Free parameters</i>			
DET1.WIN1.UIT1	0..36000	1	UVB exposure time (s)
DET1.READ.CLKDESCR	see Table 5	100k/1pt/hg	UVB readout mode
DET2.WIN1.UIT1	0..36000	1	VIS exposure time (s)
DET2.READ.CLKDESCR	see Table 5	100k/1pt/hg	VIS readout mode
SEQ.NEXPO.UVB	0..100	1	UVB number of exposures
SEQ.NEXPO.VIS	0..100	1	VIS number of exposures
<i>Fixed Values</i>			

5.1.6.7 Imaging templates

VM	XSHOOTER_img_acq +
-----------	--------------------



	XSHOOTER_img_obs, XSHOOTER_img_obs_GenericOffset
SM	XSHOOTER_img_acq + XSHOOTER_img_cal_phot, XSHOOTER_img_cal_dist
	XSHOOTER_slit_acq + SLT science or standard star templates Possibility to add: XSHOOTER_img_obs, XSHOOTER_img_obs_GenericOffset, XSHOOTER_img_cal_phot, XSHOOTER_img_cal_dist
	XSHOOTER_ifu_acq + IFU science or standard star templates Possibility to add: XSHOOTER_img_obs, XSHOOTER_img_obs_GenericOffset, XSHOOTER_img_cal_phot, XSHOOTER_img_cal_dist
	XSHOOTER_img_acq_FlatSky + imaging skyflats templates Possibility to add: XSHOOTER_img_cal_Flat

XSHOOTER_img_acq			
<i>Keyword</i>	<i>Range</i>	<i>Default Value</i>	<i>Label</i>
<i>Free parameters</i>			
TEL.TARG.ALPHA		000000.000	Target RA
TEL.TARG.DELTA		000000.000	Target DEC
TEL.TARG.EQUINOX	-2000..3000	2000	Equinox
TEL.TARG.PMA	-10.0..10.0	0.0	RA proper motion ("/yr)
TEL.TARG.PMD	-10.0..10.0	0.0	DEC proper motion ("/yr)
TEL.TARG.EPOCH	1950, 2000	2000	Epoch
TEL.TARG.ADDVELALPHA		0.0	RA differential tracking velocity ("/s)
TEL.TARG.ADDVELDELTA		0.0	DEC differential tracking velocity ("/s)
TEL.TARG.OFFSETALPHA	-36000 .. 36000	0.0	RA blind offset (")
TEL.TARG.OFFSETDELTA	-36000 .. 36000	0.0	DEC blind offset (")
TEL.ROT.OFFANGLE	-179.99..179.99 9999.	9999.	Slit position angle on Sky 9999. for parallactic angle
INS.FILT1.NAME	u', g', r', i', z', U, B, V, R, I	V	A&G filter
DET4.WIN1.UIT1	0..36000	1	TCCD exposure time
TEL.AG.GUIDESTAR	CATALOGUE, SETUPFILE, NONE	CATALOGUE	Telescope guide star selection mode



TEL.GS1.ALPHA		0.0	Guide Star RA
TEL.GS1.DELTA		0.0	Guide Star DEC
<i>Fixed parameters</i>			
SEQ.PRESET	T, F	T	Preset flag
INS.MODE	IMAG	IMAG	Instrument mode

XSHOOTER_img_acq_FlatSky			
<i>Keyword</i>	<i>Range</i>	<i>Default Value</i>	<i>Label</i>
<i>Free parameters</i>			
TEL.TARG.ALPHA		000000.000	Target RA
TEL.TARG.DELTA		000000.000	Target DEC
TEL.TARG.EQUINOX	-2000..3000	2000	Equinox
TEL.TARG.PMA	-10.0..10.0	0.0	RA proper motion ("/yr)
TEL.TARG.PMD	-10.0..10.0	0.0	DEC proper motion ("/yr)
TEL.TARG.EPOCH	1950, 2000	2000	Epoch
TEL.TARG.ADDVELALPHA		0.0	RA differential tracking velocity ("/s)
TEL.TARG.ADDVELDELTA		0.0	DEC differential tracking velocity ("/s)
TEL.TARG.OFFSETALPHA	-36000 .. 36000	0.0	RA blind offset (")
TEL.TARG.OFFSETDELTA	-36000 .. 36000	0.0	DEC blind offset (")
TEL.ROT.OFFANGLE	-179.99..179.99 9999.	9999.	Slit position angle on Sky 9999. for parallactic angle
INS.FILT1.NAME	u', g', r', i', z', U, B, V, R, I	V	A&G filter
DET4.WIN1.UIT1	0..36000	1	TCCD exposure time
TEL.AG.GUIDESTAR	CATALOGUE, SETUPFILE, NONE	CATALOGUE	Telescope guide star selection mode
TEL.GS1.ALPHA		0.0	Guide Star RA
TEL.GS1.DELTA		0.0	Guide Star DEC
<i>Fixed parameters</i>			
SEQ.PRESET	T, F	T	Preset flag
INS.MODE	IMAG	IMAG	Instrument mode

XSHOOTER_img_obs			
<i>Keyword</i>	<i>Range</i>	<i>Default Value</i>	<i>Label</i>
<i>Free parameters</i>			
INS.FILT1.NAME	u', g', r', i', z', U, B, V, R, I	V	A&G filter
DET4.WIN1.UIT1	0..36000	1	TCCD exposure time
SEQ.NEXPO	0..100	1	Number of exposures
<i>Fixed parameters</i>			
SEQ.PRESET	T, F	T	Preset flag
INS.MODE	IMAG	IMAG	Instrument mode

XSHOOTER_img_obs_GenericOffset			
<i>Keyword</i>	<i>Range</i>	<i>Default Value</i>	<i>Label</i>
<i>Free parameters</i>			



INS.FILT1.NAME	u', g', r', i', z', U, B, V, R, I	V	A&G filter
DET4.WIN1.UIT1	0..36000	1	TCCD exposure time
SEQ.NEXPO	0..100	1	Number of exposures
SEQ.NOFFSET	0..100	2	Number of offsets
SEQ.OBS.TYPE	O,S	O S	List of observation type (object or sky)
SEQ.OFFSET.COORDS	SKY, SLIT	SKY	Offset coordinate type RA/DEC or X/Y
SEQ.OFFSET.ZERO	T, F	T	Return to Origin?
SEQ.RELOFF1	-1000..1000	0	List of RA/X offsets ("
SEQ.RELOFF2	-1000..1000	0	List of DEC/Y offsets ("
<i>Fixed parameters</i>			
SEQ.PRESET	T, F	T	Preset flag
INS.MODE	IMAG	IMAG	Instrument mode

XSHOOTER_img_obs_cal_dist			
<i>Keyword</i>	<i>Range</i>	<i>Default Value</i>	<i>Label</i>
<i>Free parameters</i>			
INS.FILT1.NAME	u', g', r', i', z', U, B, V, R, I	V	A&G filter
DET4.WIN1.UIT1	0..36000	1	TCCD exposure time
SEQ.NEXPO	0..100	1	Number of exposures
SEQ.NOFFSET	0..100	2	Number of offsets
SEQ.OBS.TYPE	O,S	O S	List of observation type (object or sky)
SEQ.OFFSET.COORDS	SKY, SLIT	SKY	Offset coordinate type RA/DEC or X/Y
SEQ.OFFSET.ZERO	T, F	T	Return to Origin?
SEQ.RELOFF1	-1000..1000	0	List of RA/X offsets ("
SEQ.RELOFF2	-1000..1000	0	List of DEC/Y offsets ("
<i>Fixed parameters</i>			
SEQ.PRESET	T, F	T	Preset flag
INS.MODE	IMAGE	IMAG	Instrument mode

XSHOOTER_img_obs_cal_phot			
<i>Keyword</i>	<i>Range</i>	<i>Default Value</i>	<i>Label</i>
<i>Free parameters</i>			
INS.FILT1.NAME	u', g', r', i', z', U, B, V, R, I	V	A&G filter
DET4.WIN1.UIT1	0..36000	1	TCCD exposure time
SEQ.NEXPO	0..100	1	Number of exposures
SEQ.NOFFSET	0..100	2	Number of offsets
SEQ.OBS.TYPE	O,S	O S	List of observation type (object or sky)
SEQ.OFFSET.COORDS	SKY, SLIT	SKY	Offset coordinate type RA/DEC or X/Y
SEQ.OFFSET.ZERO	T, F	T	Return to Origin?
SEQ.RELOFF1	-1000..1000	0	List of RA/X offsets ("
SEQ.RELOFF2	-1000..1000	0	List of DEC/Y offsets ("



<i>Fixed parameters</i>			
SEQ.PRESET	T, F	T	Preset flag
INS.MODE	IMAGE	IMAG	Instrument mode

XSHOOTER_img_cal_Dark			
<i>Keyword</i>	<i>Range</i>	<i>Default Value</i>	<i>Label</i>
<i>Free parameters</i>			
INS.FILT1.NAME	u', g', r', i', z', U, B, V, R, I	U	A&G filter
DET4.WIN1.UIT1	0..36000	0	TCCD exposure time
SEQ.NEXPO	0..100	10	Number of exposures
<i>Fixed parameters</i>			
SEQ.PRESET	T, F	T	Preset flag
INS.MODE	IMAGE	IMAG	Instrument mode

XSHOOTER_img_cal_Flat			
<i>Keyword</i>	<i>Range</i>	<i>Default Value</i>	<i>Label</i>
<i>Free parameters</i>			
INS.FILT1.NAME	u', g', r', i', z', U, B, V, R, I	U	A&G filter
DET4.WIN1.UIT1	0..36000	0	TCCD exposure time
SEQ.NEXPO	0..100	10	Number of exposures
<i>Fixed parameters</i>			
SEQ.PRESET	T, F	T	Preset flag
INS.MODE	IMAG	IMAG	Instrument mode

XSHOOTER_img_cal_DetLin			
<i>Keyword</i>	<i>Range</i>	<i>Default Value</i>	<i>Label</i>
<i>Free parameters</i>			
INS.FILT1.NAME	u', g', r', i', z', U, B, V, R, I	U	A&G filter
DET4.WIN1.UIT1	0..36000	0	TCCD exposure time
SEQ.NEXPO	0..100	2	Number of exposures
SEQ.EXPO.STEP	0..36000	0	Exposure time step
SEQ.NLOOP	0..100	2	Number of loops (pairs)
<i>Fixed parameters</i>			
SEQ.PRESET	T, F	T	Preset flag
INS.MODE	IMAG	IMAG	Instrument mode

5.2 Slit masks

Table 23: Full description of the UVB slit mask.

Position	Size	Physical size (µm)	Purpose
1	0.5" Ø pinhole	126 Ø hole	CAL
2	5"×11" slit	1256 × 2763	CAL
3	1.6"×11" slit	402 × 2763	SCI / CAL
4	1.3"×11" slit	327 × 2763	SCI / CAL



5	0.8"×11" slit	201 × 2763	SCI / CAL
6	1"×12.6" slit	251 × 3165	With IFU only
7	Raw of 9 pinholes of 0.5" ∅ spaced at 1.4"	126 ∅ holes spaced by 352	CAL
8	0.5"×11" slit	126 × 2763	SCI / CAL
9	1.0"×11" slit	251 × 2763	SCI / CAL

Table 24: Full description of the VIS slit mask.

Position	Size	Physcal size (µm)	Purpose
1	0.5" ∅ pinhole	131 ∅ hole	CAL
2	5"×11" slit	1307 × 2875	CAL
3	1.5"×11" slit	392 × 2875	SCI / CAL
4	1.2"×11" slit	314 × 2875	SCI / CAL
5	0.7"×11" slit	183 × 2875	SCI / CAL
6	1.0"×12.6" slit	261 × 3294	With IFU only
7	Raw of 9 pinholes of 0.5" ∅ spaced at 1.4"	131 ∅ holes spaced by 352	CAL
8	0.4"×11" slit	105 × 2875	SCI / CAL
9	0.9" ×11" slit	235 × 2875	SCI / CAL

Table 25: Full description of the new NIR slit mask.

Position	Size	Physcal size (")	Purpose
1	0.5" ∅ pinhole	0.490	CAL
2	5"×11" slit	5.004	SCI / CAL
3	0.9"×11" slit	0.917	SCI / CAL
4	1.0"×12.6" slit	0.991	With IFU only
5	1.2"×11" slit	1.191	SCI / CAL
6	tilted slit		TECH (focus)
7	0.6"×11" JH	0.623	SCI / CAL
8	Blind		
9	0.9"×11" JH	0.904	SCI / CAL
10	0.4"×11" slit	0.386	SCI/CAL
11	Raw of 9 pinholes of 0.5" ∅ spaced at 1.4"	0.501	CAL
12	0.6"×11" slit	0.612	SCI/CAL

Table 26: Full description of the old NIR slit mask.

Position	Size	Physcal size (µm)	Purpose
1	0.5" ∅ pinhole	270 ∅ hole	CAL
2	5"×11" slit	2695×5683	CAL



Doc: VLT-MAN-ESO-14650-4942
Issue: P102v2
Date: 02.06.2018
Page: 97 of 97

3	0.9"×11" slit	485×5683	SCI / CAL
4	1.0"×12.6" slit	544×6510	With IFU only
5	1.2"×11" slit	647×5683	SCI / CAL
6	tilted slit		TECH (focus)
7	1.5"×11" slit		
8	Blind		
9	0.4" ∅ pinhole	216 ∅ hole	TECH
10	0.4"×11" slit	216×5683	SCI/CAL
11	Raw of 9 pinholes of 0.5" ∅ spaced at 1.4"	270 ∅ holes spaced by 723	CAL
12	0.6"×11" slit	323×5683	SCI/CAL