



The Danish 1.5 m Telescope in Operation!

J. Andersen, R. Florentin and K. Gyldenkerne, Copenhagen University Observatory

On November 20, 1978, Danish astronomy passed a milestone: The Danish 1.5 m telescope on La Silla made its first astronomical observations. This marks the beginning of an era we have long looked forward to, when this powerful new tool will vastly increase the scope as well as the extent of our possibilities for research in the southern hemisphere.

The early history of the Danish telescope project and its progress are described in the ESO Annual Reports from 1970 and onwards, and will not be repeated here. We believe readers of the *Messenger* will take more interest in the pos-

sibilities offered in the future, when after a test period the telescope will become available to ESO staff and visitors half of the time.

The Telescope

The telescope mounting, built by the company of Grubb Parsons, Newcastle, England, is of the asymmetrical type, closely resembling the 1.5 m telescope on Cerro Tololo. The drive employs large worm gears on both axes, with torque motors mounted directly on the worm shaft. A 500-kg mechanical preload applied through steel wires eliminates gear backlash. The tube is a classical open Serrurier structure. Primary mirror support is by astatic levers, radial support by levers acting in push-pull on brackets cemented to the edge of the mirror. There is no provision for changing secondary mirrors, as the Ritchey-Chrétien focal station is the only one used. This allows a simpler and more rigid mechanical design and greatly assists in maintaining accurate optical alignment. The telescope is capable of carrying auxiliary instruments weighing up to about 250 kg.

The Optics

The optical system is a classical Ritchey-Chrétien configuration, with a primary mirror of 154 cm diameter, primary focal ratio $f/3.5$, and final focal ratio $f/8.6$. The focal length is thus close to 13 m, and the plate scale $16''/\text{mm}$. The usable uncorrected field is about 80 mm in diameter ($20'$), with a



This is one of the first photographs obtained with the new Danish 1.5 m telescope on La Silla. It shows the nebula NGC 2081 in the Large Magellanic Cloud and was made with the 9 cm McMullan electronographic camera at the Cassegrain focus, on Ilford G5 emulsion behind a sky limiting filter (DSB = "Dark Sky Blue", central wavelength 4900 Å and width 800 Å). The exposure time was 30 min, and the picture shows fainter details than a similar 15 min direct photograph of the same object from the 3.6 m telescope.

Further observing programmes for the 25 m VLT on page 17.



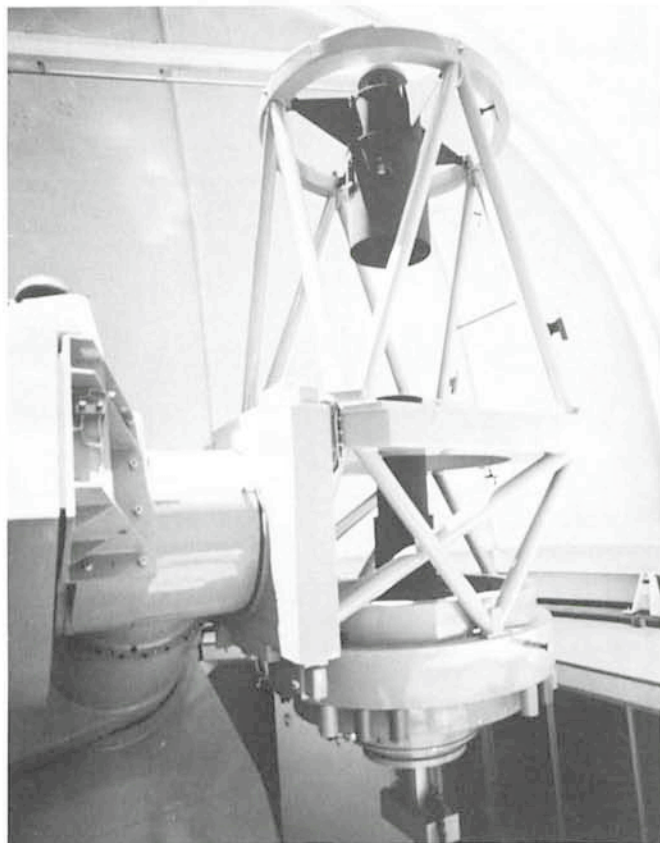

The new Danish 1.5 m telescope on La Silla.

two-element corrector up to about 200 mm (50'). The optical figuring was also done by Grubb Parsons. The contract specifications as well as the very comprehensive acceptance tests were drawn up in close collaboration with the Optics Group at ESO TP Division, based on their extensive experience from the testing of the ESO 3.6 m telescope. Laboratory tests of the mirrors, both separately and in combination, show a concentration of geometrical energy of 80 % in $0''.45$, an excellent result. The stellar images obtained during the test observations are quite satisfactory, but entirely limited by seeing which up to now has not been brilliant. Hartmann tests of the optics in the telescope will be made for a final assessment of the optical quality.

Small collimation mirrors cemented to the telescope mirrors enable us to rapidly and accurately check the alignment of the mirrors at any time. Utilizing these and other special accessories in a systematic alignment procedure also worked out together with Optics Group, the mirrors were aligned in the telescope so as to produce an E-W collimation error of less than $15''$ and a decentering coma of only $0''.1$. Tests with the telescope at 45° zenith distance N,S,E and W show that the combined effects of flexure in tube and mirror support produce a total of less than $0''.25$ of coma. We have every reason to believe that the telescope is able to take full advantage of even the nights of very best seeing.

Control and Guiding System

The computer control system for the telescope, complete with its torque motors and encoders, was built by the Controls Group at ESO TP Division. It is of the same general type as that for the ESO 3.6 m, and closely similar to those long in use at the ESO 50 cm, 1 m, and Schmidt telescopes, which simplifies its use and maintenance. Its general features (pre-setting, files of programme stars, observer control of tele-

scope speeds, etc.) will therefore also be familiar to most readers. Pointing corrections for mechanical and optical misalignment or for flexure are not yet included, but the pointing accuracy is already of the order of $10\text{--}15''$. All control and acquisition electronics and their terminals are located partly in a room on the floor below, partly in a small control room on the observing floor with a large window overlooking the observing area.

The optical characteristics of the telescope make it especially suitable for direct observations with photographic as well as more advanced detectors. For sufficiently accurate guiding of long exposures an automatic guiding system is essential, particularly because the asymmetric mounting of our telescope makes access to the focus inconvenient—to say the least—in many positions of the telescope. Since we had a common interest in the development of automatic guiders, ESO and we entered a collaboration whereby the Copenhagen University Observatory supplied the mechanical, optical and electronic hardware, and ESO, in the person of ESO programmer Alain Perrigouard, the software.

In the autoguider actually built into the Cassegrain adaptor, a movable probe picks up the light from a guide star near the edge of the field and sends it to an image dissector tube, which performs a cross-scan in the α and δ directions. If the star is not centered, the photon counts are combined to form an error signal, which after suitable checks for statistical significance is fed into the control system to correct the position of the telescope. Our laboratory measurements indicated that the device should be able to guide to an accuracy of $0''.1$ on stars as faint as 14^m and practical operation to now seems to confirm this figure.

Auxiliary Instruments

The agreement signed with ESO, and approved by the ESO Council, specifies that the telescope, complete with optics and control system, and the dome are supplied by the University of Copenhagen, and the building by ESO. It is further laid down that after an initial period of testing, ESO and Danish observers will each have half of the observing time, ESO being responsible for maintenance of the telescope, and that each side will provide its own auxiliary instruments.

Discussions are pending with the ESO Directorate concerning arrangements under which some or all the Danish auxiliary instruments might become available also to future ESO observers. At the moment, we shall therefore just briefly list those existing or under design and construction:



Spiral galaxy NGC 1637, photographed with the 4 cm McMullan electronographic camera. Ilford G5 emulsion, DSB filter. This 45 min exposure provides more detailed information about the central region than the $200''$ reproduction in the Hubble Atlas of Galaxies.



Omega Centauri, the brightest globular cluster in the sky. 10 min exposure in (Johnson) V colour. The plate was taken by S. Frandsen and B. Thomsen for the purpose of checking the electron optics, in particular the acceleration potential. There is therefore a slight elongation of the images at the edges.

An instrument adaptor with field and slit viewing optics, focusing, and autoguider; a Quantex integrating ISEC TV camera acquisition and guiding system; a small-field (80 mm) photographic camera (ESO is planning a large-field camera); 4 and 9 cm McMullan electronographic cameras with filter and shutter unit; multichannel *uvby* and $H\beta$ photometers similar to those already in use at the Danish 50 cm telescope on La Silla; a two-channel (star + sky) general filter photometer; the existing Echelle Line Intensity Spectrometer (ELIS); and a fully computerized instrument-control/photon-counting/data-acquisition system for all these.

We are collaborating with the Geneva and Marseille observatories and with ESO to use a copy of the radial-velocity scanner CORAVEL on our telescope, and the spare Boller and Chivens spectrograph for the 3.6 m should also occasionally become available. Finally, ESO has provided an

Reappointment of Director-General

The ESO Council, at its 33rd meeting on December 7, 1978, reappointed Professor L. Woltjer as Director-General of ESO for another five-year term (1980—1984).

HP-1000 computer system with disk and magnetic tape for data acquisition.

Future Programmes

At the moment, the telescope is in the testing phase where it is used by Danish observers, partly to obtain useful observations, but primarily to gain experience and find as many of its weak points as possible. Unavoidably, with a complex telescope system like this, in a dome with quite limited space, there have already been and will be many unforeseen problems which must be solved before we reach the level of stability and safety required for operation by visitors. And, as always, it is difficult to predict the time needed to solve unknown problems!

Nevertheless, the excellent quality of the long electronographic exposures already obtained, of which three are shown here, is a proof that a powerful tool is now at our hands. It will be used to continue and expand our various research programmes on Galactic structure, but the new opportunities for extragalactic work now at our disposal will not be neglected, as witnessed by the many programmes presently in preparation.

Acknowledgements

The project was kept alive through long years of technical and financial adversities by the enthusiasm and perseverance of Professors B. Strömberg and A. Reiz. We express our appreciation to the firm of Grubb Parsons for their excellent craftsmanship and cooperation, and to all parts of ESO for much help during the project—in particular to F. Franza, M. Le Luyer, A. Perrigouard, and R. Wilson of TP Division, whose expertise and enjoyable collaboration has been a constant source of pleasure.

Naming Minor Planets

According to old tradition, the discoverer of a minor planet has the right to give it a name. Nowadays, a minor planet is considered as "discovered" and worthy of receiving a number and a name, when it has been observed in at least three oppositions.

Discoveries of minor planets with the ESO Schmidt telescope started in 1975, when plates were taken near Ecliptica. Some of these planets have in the meantime been reobserved at ESO and other observatories and recently, some were observed in the third opposition. More will be coming during the next months.

The first ESO-discovered planet to be named was found on a plate that was obtained in February 1976, by Hans-Emil Schuster, in charge of the ESO Schmidt telescope. Its preliminary designation was 1976 DA. It received the number (2105) and has been named GUDY by the discoverer. The Minor Planet Circulars contain the following dedication: "Named by the discoverer for Mrs.

Gudrun Werner of Hamburg in sentimental reminiscence of college days. This Phocaea-type minor planet was found on the same blue survey plate as the large-perihelion comet Schuster 1975 II".

Minor planet 1978 AC was discovered in January 1978 by ESO astronomer Richard West. It was observed at various occasions in 1978 and on the basis of a preliminary orbit calculation, Dr. Conrad Bardwell of the Minor Planet Bureau in Cambridge, Mass., USA, was able to prove that it was identical to 1936 VJ, 1951 YJ1 and 1975 VW8. These observations were made in Nice, France (1936), Fort Davis, Texas, USA (1951), and Crimea, USSR (1975), but were too few to establish the orbit. The ESO observations therefore count as the discovery, and since 1978 AC has already been observed in four oppositions, it has now received number (2117). Although a sample of two cases may not be statistically significant, sentimental reasons seem to prevail; this planet is now called DANMARK and the dedication reads: "Named in honour of the country of origin of the discoverer."

Astronomical Broadsheets, Forerunners of the IAU Circulars

P. Véron and G.A. Tammann

Astronomical news stories have always sold well, but the way of presenting celestial phenomena to the public has changed somewhat during the centuries, from broadsheets to present-day popular journals. Drs. Philippe Véron and Gustav Tammann, at the ESO Scientific Group in Geneva, and both well known for their important work on extragalactic objects, have recently studied a large number of old texts in order to see whether they contain astronomically valuable information. It appears that although most of them emphasize the sensational rather than the strictly scientific point of view (not quite unlike many newspapers of our days!), some still give us new insight into old astronomical observations.

More than a century ago, astronomers felt the need of exchanging fast information concerning transient objects like comets, novae and supernovae. A Central Bureau was created to receive and dispatch all relevant information. During its first meeting in Rome, in May 1922, the International Astronomical Union organized, among many other commissions, a Commission for Astronomical Telegrams, which took over the responsibility of the Central Bureau. Since 1965, this commission is headed by Dr. B. Marsden at the Smithsonian Astrophysical Observatory in Cambridge, Massachusetts, USA.

However, the need for information was not new; at all times, when a spectacular event appeared in the sky, people wanted to know what it was and what it meant. This need for news covered indeed a much broader range than celestial events, and after the invention of typography in the middle of the 15th century and the diffusion of the printing press throughout Europe in the following decades, a vast number of information *broadsheets* and *tractati* were published to describe and explain every single possible event: battles, robberies, miracles, abnormal births, death of princes and kings, floods and earthquakes, fires and lightnings, crimes and accidents and, what is more interesting for us, celestial phenomena, including aurorae borealis, bolids, eclipses, conjunctions, galactic supernovae (fig. 1), comets, and even the variable star Mira Ceti. The tractati were small booklets containing up to 16 pages; the broadsheets were single sheets printed on one side, their upper half being normally covered by a dramatic title followed by an illustration, their lower half by a text. Until the beginning of the 17th century, the illustration was a xylography, most often coloured by hand or by means of stencils; then it was replaced by a copper-plate engraving or an etching.

These publications were hastily prepared, not only because the public was anxious for news but also because the competition was strong between the publishers of the same city. No evidence is available of the prices at which broadsheets were sold, or of the number produced in one printing; prices are never marked on broadsheets. The broadsheet

was manifestly intended for popular consumption and no doubt retailed at appropriately popular prices.

The size of individual editions was certainly not constant, but five hundred copies is probably the right order of magnitude; however, these sheets, like our modern newspapers, were usually not kept; they were thrown away after reading, and this is why they are now extremely rare; for most of them we know only one copy and a large number are probably definitively lost.

We know more than 220 astronomical broadsheets, most of them describing comets. The earliest broadsheet describes the meteorite which fell on November 7, 1492, in Ensisheim, a village in Alsace (now in France); the latest is a French one showing comet Donati in 1858; thus more than three and a half centuries of spectacular astronomical events are covered by these publications.

Most of the broadsheets were printed in Germany, however a few are known to have been printed in Austria, Czechoslovakia, Denmark, England, France (fig. 2), Italy, the Netherlands, Sweden and Switzerland.

The Tycho Brahe supernova of 1572 was shown on 6 broadsheets, but described as a comet on 3 of them; the Kepler supernova of 1604 has produced only one sheet. A very interesting broadsheet was printed in Stettin in 1677 to describe "the new wonderful star which appeared on the neck of the Whale at the end of this year 1677 and is still visible now as a star of third magnitude".

The variability of Mira Ceti had been discovered in 1639 by a Dutch astronomer, Phocylides Holwarda.

The earliest cometary broadsheets are dated 1531, the year of Halley's comet; since that date, each bright comet was the subject of one or several sheets. In total 28 comets have produced 208 presently known broadsheets, of which 62 refer to the exceptionally large comet of 1680.

Have these publications any scientific importance? In some cases they contain useful information on the position and the path, on early sightings and the visibility of the phenomena, but generally these data were compounded already by contemporary authors. Unfortunately the answer is therefore no, except in a few cases. One of these exceptions, where a broadsheet contributed to clarify a puzzling comet orbit, should be mentioned here.

In 975 A.D. a comet was visible for three months. Then a very bright comet with a tail length of 100° appeared in 1264 and lasted for four months. Again a "terrible" comet was observed from February to May, 1556; at peak brightness it rivaled Jupiter, and it is said to have motivated the Emperor Charles V to his abdication. For this reason it is sometimes referred to as the comet of Charles V.

The story of these three comets obtained a new dimension when their data were combined: the Canon Pingré, who is remembered for his excellent "Cométographie", computed the orbit of the comet of 1264 and noticed that its elements were similar to those of the comet of 1556. The elements of the latter had been computed before by Halley, who used the observations of Paul Fabricius, a physician and mathematician of Charles V in Vienna. Pingré concluded that the observations of 1264 and 1556 referred to the same periodic comet having a period of about 292 years; in that case also the observation of 975 would fit reasonably well, and Pingré predicted the comet's return in about 1848.

Von dem wunderbaren neuen/vnnd vor nicht mehr
gesehenen Scernen/welcher sich noch auff heutigen tag erzeiget vnd sehen lasse/in diesem
1573. Jar den zwentzigsten Januarius/ wirt hie auff das aller kürzest an-
gezeigt vnnd beschriben.



S Et zwey Monaten hat sich ein neuer
Stern von der natur Jouis vnd Martis so
hievor zu keinen Zeiten ersehen/ des himels
herfür gerhon/ welcher seines obrts vnd
gröfse halb sehr wunderbar ist. Dann erst-
lich haben des himels kündige Astronomi vñ Mathemati-
ci/ welche aller Sternen/ dhyter/ gröfse vnd natur eigen-
liche beschriben vnd eingeregistrirt an disem end des him-
mels keinen disem gleich gesehen/ noch erlebet/ weil er an
S. Jacobs straf auß dem gestirn Cassiopeia genant/ sei-
ne stralen herab wirfft/ gar nahe dreissig grad von vnser
sichrigen Polo oder Weltwürbel/ gegen dem Hauptpunc-
ten gerechnet so doch diese Constellation von ihre Zeiten her
dermassen keinen gebebt. Derhalb er auch bey vns nim-
mer vndergehe sonder abends vñ morgens daher leuchtet.
Seiner gröfse halben vbertreffe er alle anderen angebeif-
ten Firmaments stern/ also das er dem lieblichen Jupit-
er (welcher abends stracks von dem selbigen gegen Mit-
tag steht) vast züergleichen/ blinget aber vñnd zwoigert
sehr/ das es sich ansehen lezt/ er vberhöhe der Comeren
vnd Planeten weitstand von der erden/ beuorab weil er
sein obrt nicht enderet.

Auf diesem vñnd anderen dergleichen vornehmend-
en Wunderzeichen/ vñnd dem darauff folgenden trübsal/ vn-
glück vñnd allerley straffen/ so wir in Historien hin vñnd wi-
der allenthalben vberflüssig befinden/ hat jederman leicht
zuerachten/ Das sijnemlich in erscheinung der vnzuwou-

lichen/ vbernatürlichen Wunderzeichen/ wol warzunem-
en vñnd zübetrachten ist/ Denn es bezüget die tägliche
Erfahrung/ sampt vnzähligen ergangenen Geschichten/
der vorigen zeit diser Welt/ mit der that vñnd warheit/
Das auff vorgehende vñnatürliche Wunderzeich/ jeder
zeit grosse mercklich verenderung der Regiment vñnd Vn-
derthonen/ sampt allerley schrecklichen Vnsfällen/ elend/
jamet vñnd allerley straffen/ innder Welt eruolget seind/
Denn sie nicht lár abgehen/ ohne bedeutung schrecklicher
vñnsfälle/ wie dann solches im sahl der not/ auff heiliger
Göttlicher Schrifft/ vñnd allerley anderer Vöcker Histori-
en/ gnügfam zü beweisen ist. Nach dem aber bey vns/
gleiches gestalt/ diser jetzt beschribene Stern vñnd Wun-
derzeichen/ neben vielen andern auff Land vñnd Wasser/ ge-
sehenen vñnatürlichen Zeichen vñnd Wundern/ so disem
jetzt erscheinenden Sternen vorgangen/ das solche/ ohne
nachfolgende straffen/ nicht lár abgangen seind. Vñnd ist
aller dingen zübesorgen/ das Gott der Allmechtige/ als
ein gerechter Richter/ eine scharpffe Rürhen/ oder strüb-
häsem/ vber das vñnbüßfertige Teutschland/ allbereit ge-
bunden/ vñnd aufgerectt habe/ Damit er die grosse sicher-
heit vñnd vñdanckbarkeit desselbigen/ dermassen dabem
suchen vñnd straffen werde/ das wir herracher ein güte
zeit darüber zü klagen haben/ Es seye denn/ das wir inn
der zeit/ diese vñnd andere Warnungen/ zü Herzen führen/
vñnd ernstliche Büße thün/ ehe den die straffe ins werck
gebracht vñnd gesetzt werde.

Gott verleyhe vns sein gnad./ Amen.

Fig. 1: Broadsheet with Tycho's supernova by an anonymous author (January 1573). This "News sheet about the miraculous new . . . star" describes the puzzling appearance of a new star of the "nature of Jupiter and Mars" in Cassiopeia. It has been visible for two months, it is almost as bright as Jupiter, its distance appears to be larger than that of comets because it scintillates and no parallax can be detected. The author considers the star to be a sign of the wrath of Almighty God threatening changes of the government, accidents, poverty and other punishments; these dangers can be turned aside only by immediate penance. "God grant us mercy, Amen." (By permission of the Zentralbibliothek Zürich, Graphische Sammlung.)

NOUVELLE COMETE DE 1843.

Apparition d'une Comète d'une longueur qui a plusieurs millions de lieues, et qui en parcourt plus de soixante-quinze mille à la minute. — Détails remarquables donnés par M. Arago à l'Académie des Sciences. — Lettre adressée par le célèbre astronome Herschel sur cet astre extraordinaire. — Vive émotion à Paris et dans les Départements causé par ce phénomène prodigieux.



Fig. 2: A late French broadsheet about the big comet of 1843. The contrast is strong between the rather dramatic title written to attract the reader and the sober and scientific text citing Arago and Herschel. However, a ballad printed at the end shows that the public still needed some superstition in addition to the dry scientific facts: the comet is a rather good sign, the wine will be good next autumn. (Phot. Bibl. nat. Paris.)

A few years before, a Cambridge astronomer, Richard Dunthorpe, had reached the same conclusion. When the time of the expected return approached, the British astronomer Hind repeated the orbit determination of the 1556 comet and convinced himself that it was identical with the comet of 1264; however, he remarked that the orbit could have been strongly perturbed by Saturn and Neptune and its return delayed by one or two years. When in 1849 the comet had still not appeared, B. Bomme in the Netherlands attempted an accurate perturbation calculation; he found the observations wanting in quality, but by assuming that the comets of 1264 and 1556 were identical he predicted its return for the period 1858 to 1861. Then a German astrologer choose for still not known reasons—if for any at all—the arbitrary date of 1857 for the return of the comet and speculated that it would cause the end of the world on June 13. This expectation stirred quickly a mass hysteria, which bore particularly in Paris the most incredible fruits. A little novel could be written about these events, but it suffices to note that the comet of 1857 never came.

What had happened? Where was the error? The answer was provided by Martin Hoek, an astronomer at the Utrecht observatory; he proved conclusively that the comets of 1264 and 1556 were *not* identical. Hoek's decisive advantage was that K. L. v. Littrow had not only found a pamphlet by Joachim Heller, which contained additional observations of the 1556 comet, but also the original source with Fabricius' observations: it was a broadsheet with a map of the comet's course! Littrow's discovery in the State Archives of Vienna occurred already in 1856, but its implications remained unnoticed until Hoek. Pingré and Hind had searched in vain for this original source, yet once it had been found it could be shown that Halley had not used this original source, but only a much deteriorated version of Fabricius' map, published by Lycosthenes in Basel in 1557.

The Vienna broadsheet seems to be lost again. But fortunately a Latin translation of the same sheet was discovered a few years ago. It has survived to our days because it had

served as an end-leave of a folio volume, and it is now in the Houghton Library in Cambridge, Mass. (fig. 3).

While the scientific yield of astronomical broadsheets is generally meagre they still contain a wealth of other information. They are interesting for the historian of astronomy, because they give insight into the contemporary interpretation of celestial events; some of the broadsheets are even signed by well-known astronomers, such as Johannes Schöner, Peter Apian, D. Herlicius, W. Schickard, and A. Kircher. Thus they contribute to the bibliography of quite a few astronomers and, of course, they also give a more complete picture of the production of many printers, some of which, as it turns out, were specialized in the printing of broadsheets. Other sheets are, with their illustrations, of interest for the historian of art and, surprisingly, for historians of literature and church songs, because during the baroque they frequently contained poems or songs on the "frightful" sightings. But above all the broadsheets demonstrate in a very impressive way the fascination in celestial events and particularly comets, which people felt in former times. It is a matter of course that this fascination revolved around many superstitious and astrological views, and for the knowledge of these views and their gradual change the broadsheets are a very important source.

COMETA VISVS MENSE MARTIO. LVI. ANNO.

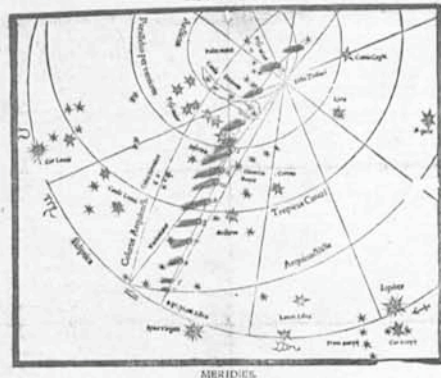

REVERENDO IN CHRISTO PATRI AC DOMINO DO.

MINO GEORGIO RICARDO ABBATI IN CAMPO LILIDRYM. VISO FIG. DOMINO PATRONO SVO. S. D.

PAVLVS FABRICIVS LAVENSIENSIS SEQVVS ROMANORVM MATHVMATICVS

Fig. 3: Broadsheet of 1556 showing the course of the comet of that year. Its author is Paul Fabricius, Imperial Mathematician in Vienna. Only the upper part of the broadsheet is shown here. The Latin text, consisting of 50 lines, describes briefly the observations and speculates on the comet's effects from an astrological and Christian point of view. (By permission of the Houghton Library, Harvard University.)

Tentative Meeting Schedule

The following dates and locations have been reserved for meetings of the ESO Council and Committees:

May 15	Scientific Technical Committee, Geneva
May 16	Committee of Council, Geneva
May 17	Users Committee, Geneva
May 29–31	Observing Programmes Committee, Liège
June 12	Finance Committee, Munich
June 13	Council, Munich

Astro-Archaeology: Observations at La Silla of Some Old Halo Stars

F. Spite and M. Spite

When, where and how were the heavy elements produced in the young Universe? Present theories say that it mainly happened in supernova explosions, but only accurate observations of very old stars can show whether this is true or not. Drs. Monique and François Spite from the Paris Observatory in Meudon recently started a study of very metal-deficient stars in the Galaxy to see if there are minor differences in the abundances of the individual metals, as predicted by theory. Here they inform us about the reasons for their observations and give some of the first results.

Like an archaeologist, who traces the history of mankind by analysis of fossils from different, more or less remote epochs, the astronomer can try to learn the evolution of the Universe by analysing old stars which were born when the Galaxy was young.

Element Synthesis in the Universe

It is generally believed that the observable Universe began in a cosmic explosion (the Big-Bang) of which a characteristic fossil is the 3°K radiation.

During the first few minutes of this Big-Bang was formed all the Hydrogen and the larger part of the Helium now present in the Universe. This gas condensed afterwards in huge clouds which in turn condensed into protogalaxies. In these protogalaxies, some material condensed into stars. The chemical composition of their atmospheres should be the same as the composition of the material formed in the Big-Bang: essentially Hydrogen, Helium and possibly a small amount of Lithium. In the core of these first-generation stars, the metals began to be synthesized through successive nucleosynthesis processes: helium burning, carbon burning, silicon burning (this last process, in particular, builds all the elements of the iron peak). When, at the end of their life, the stars exploded as supernovae, the produced metals were dispersed and mixed into the interstellar medium, ready to be included in the second-generation stars. These metals are called *primary metals*, i.e. metals built by first-generation stars.

It is an important fact that these stars apparently were unable to build all kind of metals. For instance, Barium is built through irradiation of iron seed nuclei by slow neutrons (the "s" process). Present theories show that during the evolution of a first-generation star, the slow neutron flux arises before the iron nuclei are formed. For this reason, Barium (as well as all other elements formed by the "s" process) is called a *secondary* element. If the mass of the first-generation stars were large, they must have been rapidly transformed into supernovae, and it is generally assumed that the young galaxy was quickly enriched in metals.

If some first-generation stars still exist at the present epoch, then they must be of small mass, in which case the

evolution is indeed very slow. But small-mass, unevolved stars are statistically faint, and hard to detect: moreover, cool stars displaying only hydrogen lines in their spectra could be easily confused with reddened, hot stars. For all these reasons, it is not surprising that, up to now, no stars without metals are known. They are the "missing link" of astro-archaeology.

Second-generation stars are expected to contain a small amount of primary metals, such as Iron, and absolutely no secondary elements such as Barium. But these stars are now able to build small amounts of secondary elements in their core, while at the same time building primary metals. In the supernova phase, they inject all these elements into the interstellar material, which will later form the third-generation stars.

The third-generation stars are expected to display a large deficiency of all the metals and particularly of the secondary metals. Indeed the well-known star HD 122563 analysed by Wallerstein and his collaborators in 1963 is very metal-poor (300 times less metals than in the Sun) and it is still poorer in secondary metals such as Barium.

Observations of Halo Stars

This overdeficiency of Barium, sometimes called the ageing effect, was not always found in other metal-poor stars, so the situation was rather confused. We therefore decided to select and analyse a few very metal-poor stars, in order to get a better understanding of the chemical evolution of the Galaxy, and to corroborate the above outlined theory of nucleosynthesis.

When we began this work in Chile, we had on our side the clear sky and the good seeing of the La Silla observatory, as well as the advantage of a luminous and efficient spectrograph at the coudé focus of the 1.52 m telescope. At a dispersion of 12 Å/mm, its resolution is excellent. Against us were the relatively low efficiency of the photographic plates and the relative faintness of the stars. Later, the observations were continued with the échelle spectrograph and the Lallemand-Duchesne electronic camera: for a similar resolution, the accuracy is higher, and the necessary exposure times are much smaller. However these observations have so far been restricted to the blue spectral range.

We analysed three stars similar to HD 122563. This increased by a factor of two the number of stars which had been analysed in detail and which were metal-deficient by a factor of more than 200 relative to the Sun. Furthermore, B. Barbuy analysed a moderately metal-poor star (10 times less metals than in the Sun). Let us note here that the metal deficiency of HD 122563 is sometimes quoted in the literature with more extreme values (for instance 1/1000 of the solar metal content), but this is often due to the adoption of a different temperature scale. In order to compare on a sound basis the abundance of two stars, it is necessary to use the *same* temperature scale, and this is not always easy.

With the increase of the sample of very metal-poor stars that have been analysed in detail, the situation has become clearer. The main results of our study, which have some im-

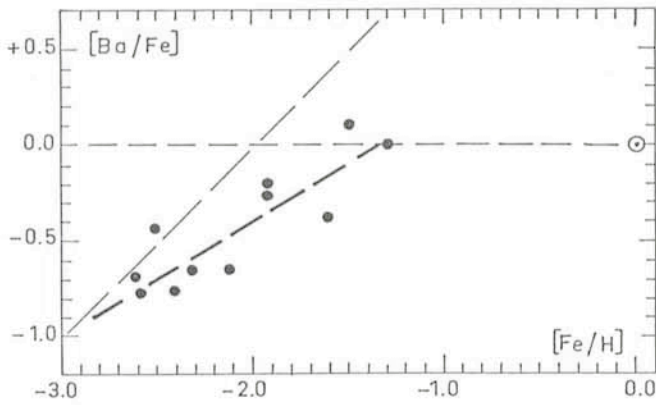

Fig. 1: The $[Ba/Fe]$ logarithmic ratio versus $[Fe/H]$ (thin line: 45° line, thick line: mean relation).

plications on current nucleosynthesis theories, are presented below.

1. Elements Built During the Carbon Burning Phase

Among the elements which are built during the carbon burning phase, it is possible to observe Aluminium, Sodium (Na) and Magnesium. The "pure explosive carbon burning theory" predicts that the elements with an odd number of neutrons are secondary elements. Accordingly, ^{27}Al and ^{23}Na should be more deficient in very old metal-poor stars than ^{24}Mg . But we were never able to find such an "overdeficiency".

On this point, our observations lead to a result that is different from the one obtained by R. Peterson. He undertook a similar study, at about the same time, with the échelle spectrograph at Mount Hopkins (Massachusetts, USA) and analysed metal-poor stars in the northern hemisphere. We first thought that this discrepancy was a result of differences in interpretation and not of the measurements. However, we undertook new observations and measurements of aluminium lines in our stars, also using échelle spectra. It seems that the new spectra confirm our first conclusion, that Aluminium is *not* overdeficient relative to Magnesium. We are at present working on this point.

Anyhow this result is not completely unexpected: Arnett and Wefel recently concluded that the explosive carbon burning is preceded by an hydrostatic burning of carbon. Following their theory, if carbon burning is even partially hydrostatic, odd elements like ^{27}Al and ^{23}Na can be built in first-generation stars (as primary elements) and no overdeficiency of these elements is then expected in metal-poor stars.

2. The "s" Process Elements

Figure 1 shows the behaviour of the logarithmic ratio $[Ba/Fe]$ relatively to $[Fe/H]$. Let us recall the meaning of the classical notation:

$$[X] = \log (X^*/X_\odot)$$

The stars which have a mean metal-deficiency of a factor 300 (relative to the Sun), i.e. $[Fe/H] = -2.5$, have a Barium deficiency 5 times more extreme (1500 times less Barium than the Sun). This Barium overdeficiency disappears when the iron deficiency is more moderate than $[Fe/H] = -1.3$, i.e. 1/20 of the solar iron content. The graph explains why some authors were talking about a Barium overdeficiency and others were not. It all depends on the level of iron deficiency.

Another element, mainly built by the "s" process, is also observable: Yttrium. We could establish (fig. 2) an overdefi-

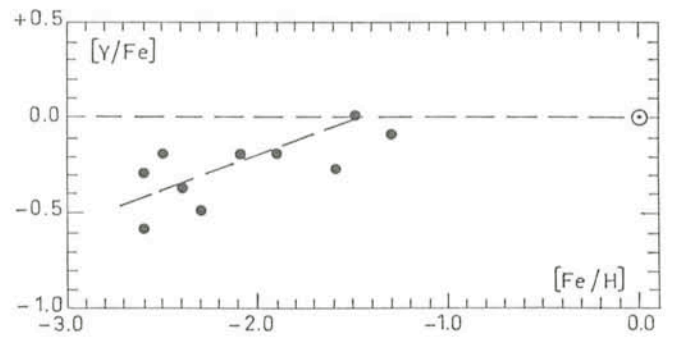

Fig. 2: The $[Y/Fe]$ logarithmic ratio versus $[Fe/H]$.

ciency of Yttrium, quantitatively smaller than the overdeficiency of Barium. This is in agreement with theory and gives some support to the present theories of the formation of the "s" elements.

3. The "r" Process Elements

Europium is one of the very few "r" process elements which are observable in cool stars. The "r" process elements are formed by rapid addition of neutrons to iron peak elements. In contrast to the "s" process, a very high flux of neutrons is required. Europium belongs to the "rare earth" group, like Barium or Yttrium, but its behaviour seems very different. The deficiency of Europium is, within the measurement errors, the same as the deficiency of Iron. Europium is therefore a primary element; this induces us to think that it is built at the same time as Iron, during the silicon burning, when the star explodes as a supernova.

Future Work

This work does not yet give a complete picture of the chemical evolution of the Galaxy due to element building in stellar cores. We have begun with B. Barbuy an analysis of the abundances of Carbon, Nitrogen und Oxygen in these stars. It would be desirable to extend the sample, to find and to analyse other very metal-poor stars. An échelle spectrograph mounted at the Cassegrain focus of the 3.6 m telescope would provide us with the opportunity to analyse the chemical composition of the very old stars of the globular clusters. It would be possible to reach very distant stars which may possibly be even more extreme and represent a sample of the material of the remote past. Will it be possible to find stars of first or second generation? Will it be possible to observe differential abundances of metals in the stars of nearby galaxies? It is worth trying, since such observations would be a significant contribution to our understanding of the birth of the elements in the Universe.

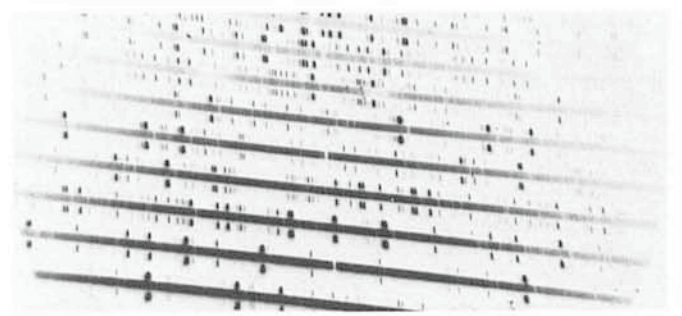

Fig. 3: A spectrum of the metal-deficient star HD 184711, obtained with the Echelle spectrograph at the 1.52 m telescope.

Infrared Observations of Stellar Birth-places

N. Epchtein and P. Turon

A few months ago, Drs. Nicolas Epchtein and Pierre Turon went to La Silla and mounted their specially-designed infrared photometer at the Cassegrain focus of the ESO 3.6 m telescope. Although the weather was unusually unpleasant, they succeeded in measuring a number of H II regions. In this article, they review observations of star birth-places in various spectral regions.

neutral clouds, discovery of large molecular clouds associated with cool dust and detection of OH and H₂O masers associated with infrared objects are the most conspicuous advances in the observational field. From these observations, astronomers have been able to set up a phenomenological picture of a typical star birth-place (fig.1).

Observations of Stellar Birth-places in Different Spectral Regions

The only presently available technique to discover directly star-like objects in young complex regions is the near-infrared mapping and photometry with middle- and large-size ground-based telescopes. Far-infrared and millimetric observations are indeed of limited spatial resolution (~ 1 arcmin). As for H₂O masers mapped with aperture synthesis (radio) techniques, it is still unclear whether they are actual protostars or regions of peculiar physical conditions located at the edge of cocoons formed by newly-born, massive stars.

The earlier stages of star formation are still badly understood, theoretically as well as observationally, although a large amount of new relevant observations have been provided during the last decade thanks to the new spectral ranges opened to astronomical research: infrared and microwaves. Detection of optically invisible infrared point sources associated with compact H II regions or dense

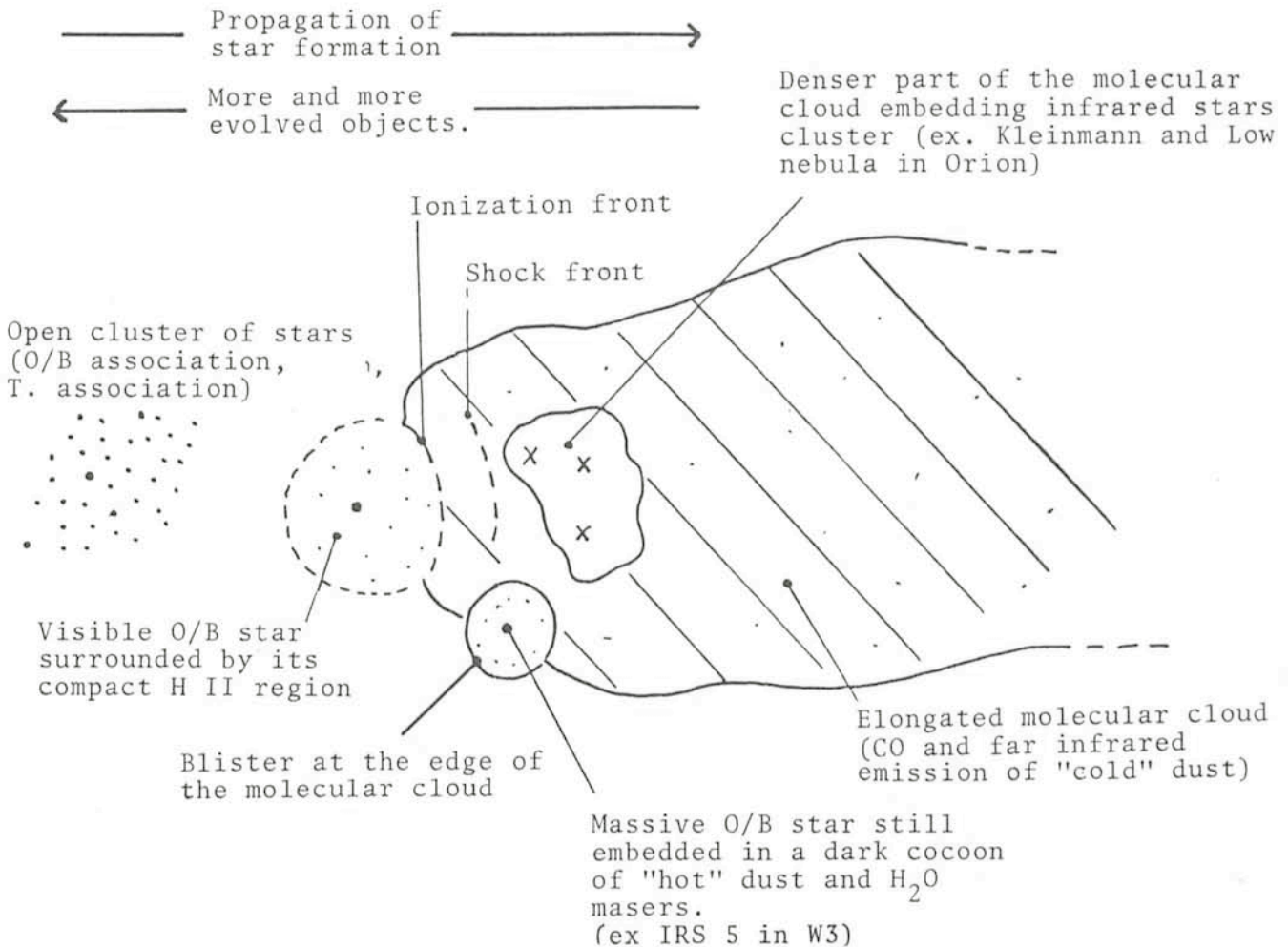

Fig. 1: A tentative scheme of a typical stellar birth-place as deduced from recent radio molecular and infrared observations. The massive O/B stars are first formed at the edge of a molecular cloud. The ionization front goes forward inside the cloud leading to pressure instabilities (H₂ dissociation and temperature rise). The densest parts of the cloud are associated with infrared star clusters which are likely newly-born stars.

Scanning of compact H II regions and of the densest parts of molecular clouds is an efficient way of detection of newborn stars. The study of the infrared colours can then provide a determination of the nature of the objects. Large colour indices mean a cool object or a highly-reddened star; in both cases an interesting object, related to the H II region or the molecular cloud: either a cool dust shell, a cocoon, surrounding a hot object still unable to ionize an H II region large enough to be detected in radio continuum, or an intrinsically cool object like a protostar in the free-fall phase or an early O-type star dimmed by several magnitudes in the visible and often associated with a very compact H II region.

Until now the criteria of determination are still unclear since the number of newly-discovered sources remains small except in a few well-studied regions like Orion or the molecular cloud ρ Oph. If the object is assumed to be a reddened star, the infrared colours and a standard law of extinction can lead to a rough estimation of the spectral type and of the visual extinction. Moreover, if the distance is known, the absolute visual magnitude and hence the accurate spectral type may be derived. The evaluation of the integrated radio continuum emission over the whole H II region can confirm the presence of an optically unseen O-type star. Mapping at longer wavelengths (10 and 20 microns) is also of great value in order to detect colder objects or even more reddened stars and to determine total luminosities of H II regions, dust temperature and dust-to-gas densities ratios in the ionized medium.

In the southern sky, only a few objects have been mapped, either at 2 or 10 microns, and even fewer with high spatial resolution, obviously because of lack of large telescopes. This situation recently changed when three large optical telescopes became operational in the southern hemisphere. Resolutions of 1 or 2 arcsec at 10 microns can be obtained with telescopes of the 3.6 m class and without sophisticated techniques. The immediate result has been the discovery of complex structures in objects that looked simple at lower resolution.

Southern Compact H II Regions

A programme of mapping and photometry of the most compact southern H II regions was started in 1977 at the 1 m telescope with the standard ESO photometers. More recently, a

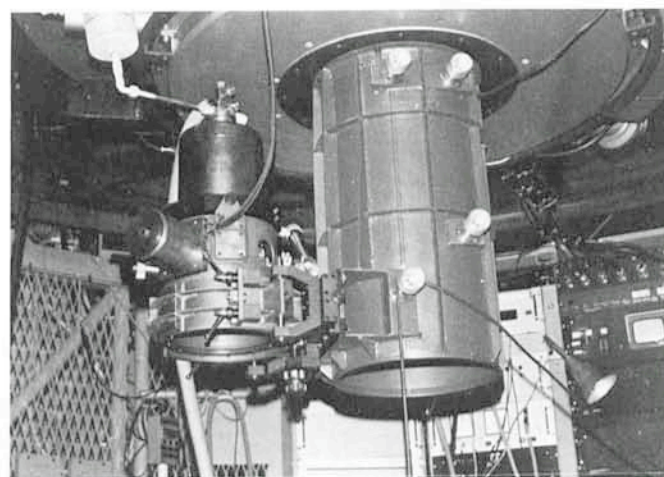

Fig. 2: The infrared photometer fixed at the Cassegrain focus of the 3.6 m telescope. The dewar is seen on the left side of a tube which holds the "hot" optics and the modulator. The preamp. box and the filter driving handle can be seen on the left side of the dewar.

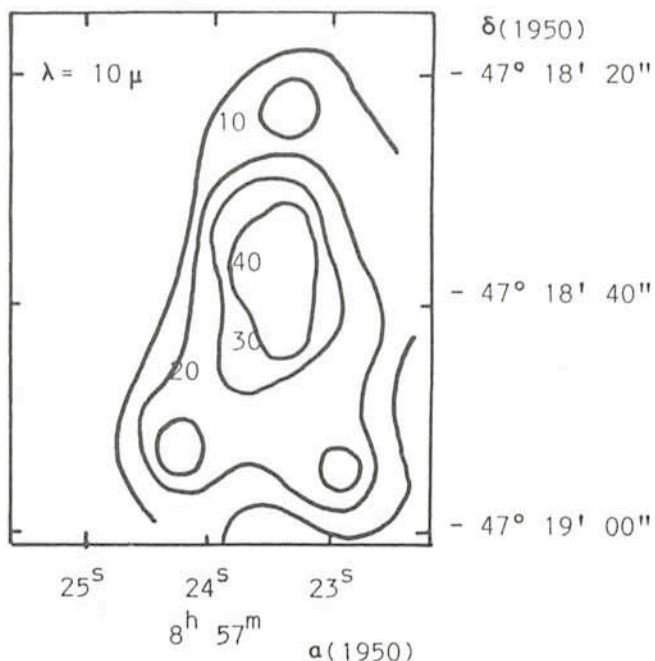

Fig. 3: Ten-micron map of the compact H II region RCW38-IRS1, obtained with the ESO 3.6 m telescope. The resolution is 7 arcsec. The unit of intensity is 2.5 janskys (i.e. the contour labelled "40" corresponds to 100 janskys).

home-made photometer was used at the 3.6 m telescope. This instrument, which was built at the Meudon Observatory, is fixed at the Cassegrain f/8 focus (fig. 2). It is made up of a liquid helium, liquid nitrogen jacketed dewar which holds a set of 8 cooled filters (in the range 8-30 microns), a 7 arcsec diaphragm and a Low germanium bolometer with a holding time of more than 30 hours. Since the ESO 3.6 m telescope is not yet equipped with a wobbling secondary mirror, an internal modulator is needed. Beam-switching is

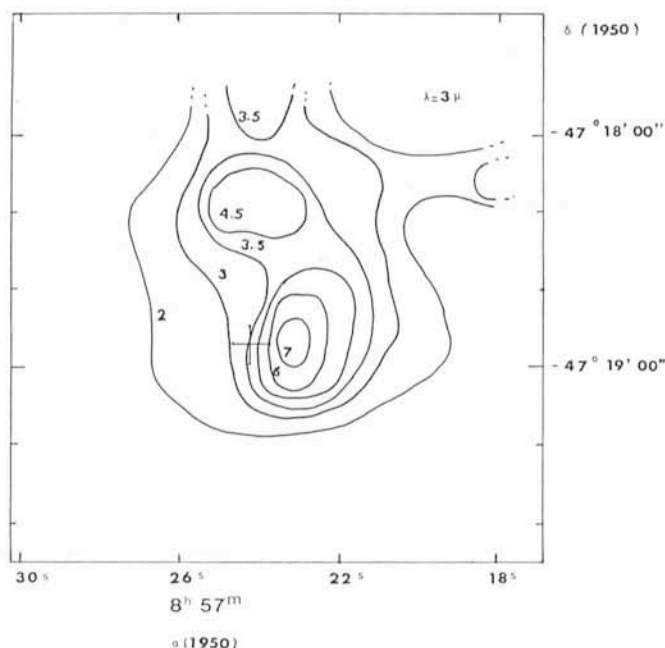

Fig. 4: Three-micron map of RCW 38 obtained at the 1 m with the ESO InSb standard photometer. Resolution is 13 arcsec. Contour units are in .1 jansky in the diaphragm. The cross shows the location of IRS 2 which seems to be the exciting star of RCW 38.

achieved by a spherical mirror mounted on the axis of a torque motor driven by a square wave generator and located at the image of the entrance pupil. This device is able to perform a square wave beam-switching of more than 30 arcsec at $f = 30$ Hz.

Despite rather bad weather conditions and although several points must be improved (baffling of the detector, data-acquisition system), our first run at the 3.6 m was very encouraging. We mapped several H II regions in our galaxy and the large LMC H II region, 30 Dor. The most significant result was obtained on the core of RCW 38 IRS1. We improved the resolution of the previous mapping by Frogel and Persson (1974) and discovered a complex structure of the source at 10 microns (fig. 3). The analysis is in progress to determine whether the structure is due to the presence of a cluster of sources or to a variation of dust opacity.

Maps of the same region were obtained at 2 and 3 microns at the 1 m telescope (fig. 4). At 3 microns the map is roughly similar to the map at 10 microns with the same resolution, a

result which seems to indicate a smooth variation of dust temperature over the H II region and to support the idea that dust is more likely heated via Lyman α photons resonantly trapped inside the ionized medium than via Lyman continuum photons.

The mapping of 30 Dor was quite disappointing since we did not detect any source in a 40 x 40 arcsec area around the central exciting star R 136 at a level of 4 janskys at 10 microns in the 7 arcsec diaphragm. This result seems to be in agreement with the assumption that, in this region, the "hot" dust has been already blown away by stellar winds while "cold" dust is seen at 100 microns (Werner et al., 1978). We plan to reobserve this region at 20 microns under better weather conditions.

References

- Frogel, J. A., Persson, S. E., 1974, *Astrophys. J.* **192**, 351.
 Werner, M. W., Becklin, E. E., Gatley, I., Ellis, M. J., Hyland, A. R., Robinson, G., Thomas, J. A., 1978, *Mon. Not. R. Astron. Soc.* **184**, 365.

New Clock System for La Silla

One of the features of the La Silla observatory that impresses visitors most is the incredible number of clocks. Sure, nobody doubts that astronomers need accurate time—but why so many clocks?

The simple answer is that different times are used at an observatory for different purposes. We are all familiar with the *Local Time*, which on La Silla is the time used in Chile for civic purposes. In winter, it is 4 hours behind GMT (Greenwich Mean Time) and during the summer it is advanced by 1 hour. The time difference between Geneva and München in Europe and La Silla is therefore 5 hours from April to October and 4 hours during the rest of the year.

Astronomers often use the so-called *Universal Time* (UT) for their observations. Originally, UT was equal to GMT, but after introduction of a standard second that is based on the caesium atom (9 192 631 770 periods per second), a new system, the so-called *Universal Coordinated Time* (UTC), has come into use. This system is kept in step with the mean solar time, as defined by the motion of the Sun. Since the rotation of the Earth is slowing down, it is occasionally necessary to insert an extra second in the UTC.

Finally, the positions of celestial objects in the sky are given by the *Sidereal Time* (ST), which is determined by the stars.

On La Silla, Local Time, Universal Coordinated Time and Sidereal Time are shown. Until now, all clocks have been synchronized by a quartz clock, installed in the Schmidt building. However, this clock cannot be directly connected to the various telescope control systems. Furthermore, there is an increased need on La Silla for having a very high accuracy in time measurements, for instance when measuring ultra-rapid variations in quasars, etc.

It has therefore been decided to install a new clock system on La Silla, and a Caesium Beam Frequency Standard was ordered by Cermé in Paris, France. After a test period of six weeks in Geneva it will be shipped to La Silla. The accuracy should be sufficient for all purposes: for UTC it is better than 0.0001 sec/year and for ST it is better than 0.01 sec/year. In other words, we have to wait at least 10,000 years, before it is

wrong by 1 second! Remains to be seen whether there will still be astronomers at La Silla by that time.

M. Ziebell and R. West

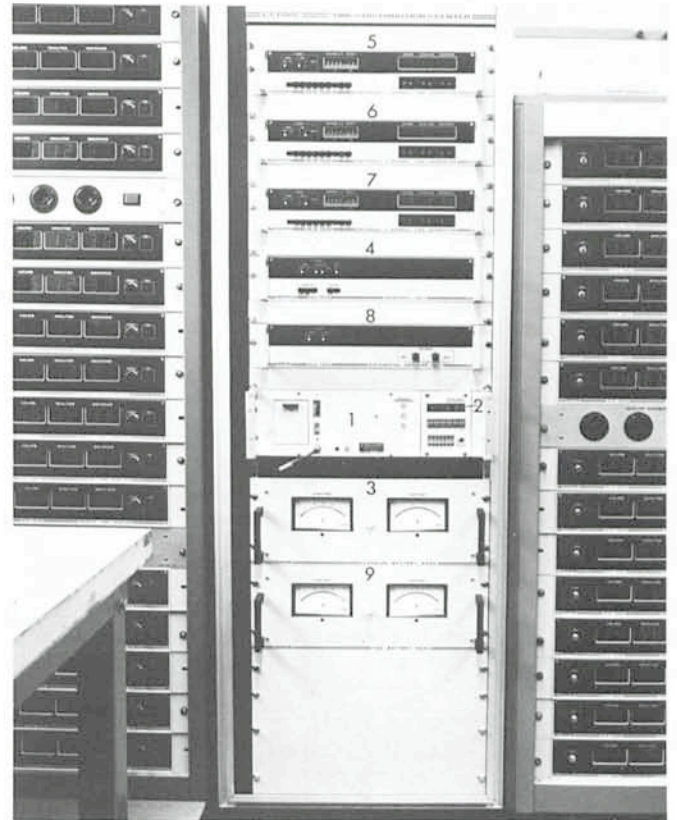

The new atomic clock for ESO-La Silla. The various components are marked on the figure: (1) caesium frequency standard, (2) clock for time transport, (3) battery pack for time transport (10 hours), (4) frequency unit, (5) UTC time code generator, (6) ST time code generator, (7) spare time code generator, (8) line drive amplifiers, (9) battery pack for non-break power (4 hours).

Recent Improvements in the Optical Quality of the La Silla Telescopes

R. Wilson and F. Franza, ESO Optics Section, Geneva

Last spring the Director-General of ESO, Professor Woltjer, asked the Optics Section in Geneva to investigate systematically the optical quality of all the La Silla telescopes and make any necessary improvements to bring all instruments up to the maximum of their potential. Of course, we have been concerned with the 3.6 m telescope throughout its construction and installation, but the extension to the other telescopes was a major new commitment, requiring considerable time and effort as well as the understanding and cooperation of our colleagues in Chile.

The more stable a telescope, the better it will perform and the less maintenance it will require to keep it "optically" in good condition. Thus the new 1.54 m Danish telescope should be a very favourable case with its single Cassegrain configuration, whereas the 3.6 m telescope with its three observing stations and multiplicity of inevitably complex equipment is clearly a much more difficult instrument to maintain.

We have put the word "optically" in inverted commas above for a quite specific reason. The "optics" of a telescope are intrinsically quite stable elements: unless they are scratched, chipped or broken, the elastic properties of the materials of which they are made *guarantee* that they retain the same intrinsic characteristics they had when leaving the optical manufacturer. But the intrinsic optical quality, which is determined by the optical design and the manufacturer's skill, will only be realized in practice if the telescope mechanics are functioning correctly where they impinge on the optics, namely in support systems and mechanics affecting the relative centering of elements. The sort of errors that can be induced by such *mechanical* defects as distinct from intrinsic optical defects are discussed in detail in ESO Technical Report No. 8. Maintenance of telescope optics is, in fact, simply a specialized form of *mechanical* maintenance to prevent the occurrence of these defects, mainly coma, astigmatism and image tilt.

3.6 m Telescope

At the beginning of 1978 there were complaints from users that the earlier excellent optical quality at the prime focus had deteriorated. This was not altogether surprising in view of the volume of work and frequent changes inevitable with the commissioning of the telescope for routine observation. Plates showed a variable situation indicating mixtures of image tilt (tilt of the plateholder to the beam), astigmatism and coma. This situation was investigated last April.

The astigmatism and coma were found to be due to leaks in the air feeds to about a third of the lateral support cushions of the prime mirror. This had three effects. First, the mirror was incorrectly supported, particularly in certain azimuths, in inclined telescope positions, leading to astigmatism in such inclinations. Secondly, the inadequate support caused the mirror to slip sideways on inclination of the telescope which produced massive asymmetrical forces at the lateral fixed points. This also produced astigmatism which, since the mirror did not necessarily slip back when the telescope was restored to the vertical position, was often

also present in the zenith position. Thirdly, the lateral side slip produced decentering coma of variable amounts. After correction of these leaks and application of a suitable preload to the lateral fixed points, there has been no further evidence of prime mirror slippage. Careful measurements have been done here with probes, also at the top unit. Another possible source of slippage—of the PM cell at the flexion bars—has also been dealt with.

The image tilt error was caused by a mechanical defect in the pedestal (the unit supporting the PF adapter) of the top unit. It was known that a basic error existed in the focusing system causing a tilt and this had been provisionally corrected by a wedge spacer which had not been mounted with the intended orientation. Last October, this tilt error was corrected at its source in the focusing system and all flanges checked, the temporary spacer wedge being removed. The final result was very satisfactory—a maximum tilt error of less than $2\frac{1}{2}$ arcmin for the least favourable pedestal rotation. This was measured by a sighting telescope mounted below the Cassegrain adapter and a plane mirror in the plateholder. This tilt error is below the tolerance (3 arcmin) even for the larger field of the triplet corrector, soon to be installed.

Such operations require much mechanical handling and are very time-consuming. By comparison, centering of the telescope in the prime focus is a relatively simple matter in which we now have much experience. The centering is performed by translating the pedestal, which includes the corrector whose optical axis must be brought into coincidence with that of the prime mirror, by the "x-y movement". The amount and direction of the movement necessary is determined by what we call "pupil plates" to distinguish them from "focus plates". The principle of this method has been known for at least as long as high-quality Cassegrain telescopes have existed, but its precision when applied photographically is surprisingly good. It is essentially the same as a Hartmann test but the "screen" is simply the two concentric circles defining the outside of the pupil and its central obstruction. If the image is defocused to give an image of about 2 mm (this seems about the optimum in the prime focus), the form of the pupil can easily be measured in a projection device. Coma displaces the inner circle relative to

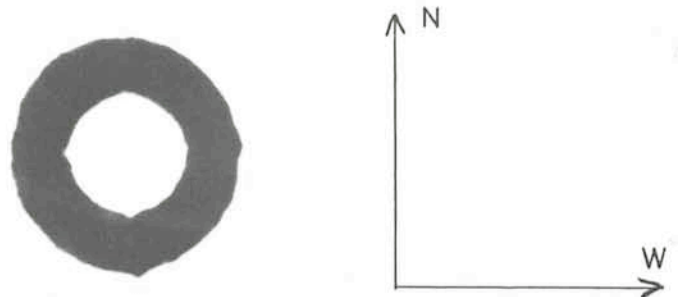

Fig. 1 (ESO 3.6 m telescope): (Pl. 1 p) "Pupil plate" for the 3.6 m telescope showing 0.6 arcsec of decentering coma. A corrector translation of 1.4 mm was required to correct this. (Original image diameter ca. 1.5 mm.)

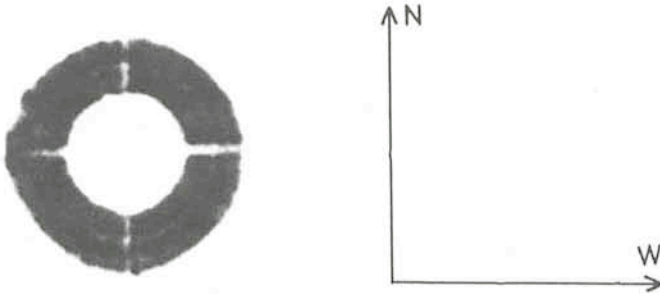

Fig. 2 (ESO 3.6 m telescope): (Pl. 3 p) "Pupil plate" for 3.6 m telescope after centering to <0.3 arcsec of coma. The judgment of symmetry of the pupil was made at 45° to the spider to avoid local turbulence disturbance. (Original image diameter ca. 1.5 mm.)

the outer one. By applying certain conversion factors, the coma and the necessary shift of the corrector can be deduced from this asymmetry. It is also possible to determine other defects from such pupil plates, notably astigmatism and spherical aberration. The precision obtainable depends on the seeing, particularly the "internal" dome seeing which gives pupil distortions which cannot be integrated out by longer exposures.

Figure 1 (Pl. 1p) shows a typical pupil plate before recentring, corresponding to 0.6 arcsec of coma and requiring a shift of 1.4 mm of the corrector. Figure 2 (Pl. 3p) shows the result after final centering—the residual error here is < 0.3 arcsec and is near the limit of detectability with the moderate seeing at the time.

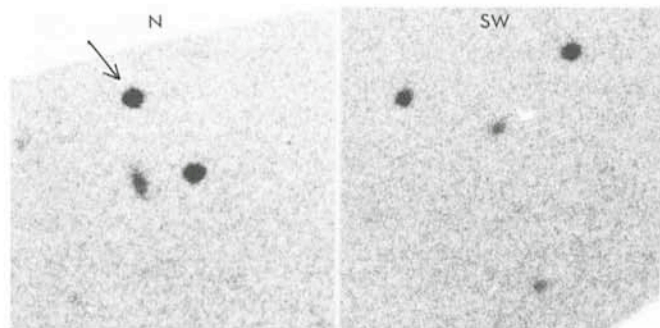

Fig. 3: Two fields from the extreme edge of a plate taken with the 3.6 m telescope at the prime focus by Hans Schuster of NGC 55 (45 min on baked IIIa-J with filter GG 385). At the extreme edge of the field in the N direction (left field), slight asymmetry of star images is detectable on the original where the theoretical edge field coma (ca. 0.25 arcsec) has vectorially approximately added to the small decentering coma residual (ca. 0.25 arcsec uniform over the whole field). The second field in the SW direction shows no detectable asymmetry on the original because the coma vectors have approximately subtracted.

Figure 3 (Pl. 8p) shows a test photo of NGC 55 kindly taken and guided by our colleague Hans Schuster using a baked IIIa-J plate with filter GG 385. The exposure time was 45 mm and the zenith distance about 20° – 25° . The seeing estimate was about 2 arcsec and the smallest images are about $1\frac{1}{2}$ arcsec. At the edge marked with the arrow, it is possible on the original to detect a slight asymmetry due to coma. This corresponds to the side of the field where the residual decentering coma (about $\frac{1}{4}$ arcsec, and constant in amount and direction over the whole field) adds up vectorially with the theoretical residual of the corrector field coma (about $\frac{1}{4}$

arcsec at the edge of the field and radially directed towards the centre of the field). This demonstrates that, even with moderate seeing, very high centering precision is worthwhile if top-quality results are desired.

Centering in the Cassegrain focus must be done by tilting the secondary until coma compensation is achieved. We found that the tilt necessary was slightly beyond the tilt range provided. This is a sign that the "collimation error" (angle between the normal to the δ -axis and the sighting direction of the telescope) exceeded considerably the original tolerance. This was not surprising since the basic alignment to the δ -axis had not been repeated because of lack of time. But the result was that we had to leave 0.45 arcsec of uncorrected decentering coma in the Cassegrain—not a large amount but more than the tolerance for optimum performance with good seeing. It is intended to repeat the basic alignment and centering next July to correct this, an operation anyway essential for the subsequent coude installation.

Apart from this small residual centering defect in the Cassegrain system, the optical performance of the telescope is excellent.

Danish 1.54 m Telescope

The optics for this telescope was figured by Grubb-Parsons under most exacting test procedures. It was therefore with considerable confidence that we set about the basic adjustment of the optics last November, with excellent cooperation from our Danish colleague, Johannes Andersen. The result of a detailed alignment procedure was a final collimation error of the centered telescope of < 0.25 arcmin.

Centering was then performed by "pupil plates". Figure 4 shows a pupil plate for the zenith after centering to a coma of < 0.3 arcsec and similar plates for inclinations of about 45° in the S, N, E and W directions. The negligible variation of coma proves the excellent mechanical rigidity of the telescope.

The qualitative evidence of the image quality (under moderate to indifferent seeing conditions) indicated that it was very good. Hartmann tests were intended but could not be

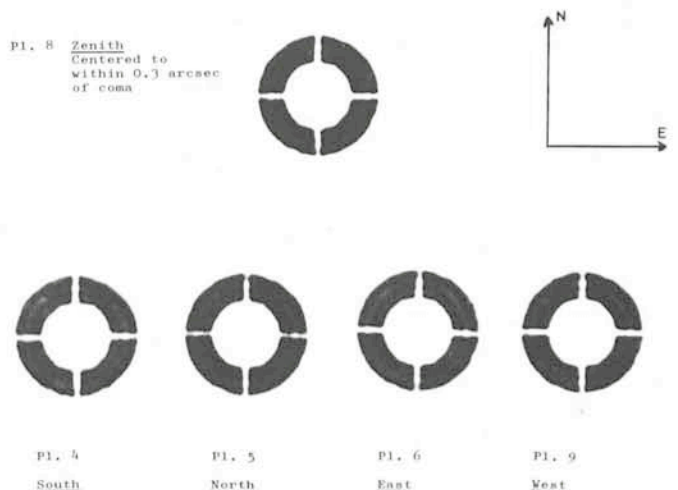

Fig. 4 (Danish 1.54 m telescope): After centering in the zenith to the quality shown in Pl. 8, the telescope was inclined at about 45° in all four directions. The pupil plates show a negligible variation proving the excellent mechanical stability of the telescope. (Original image diameter ca. 2.5 mm.)

carried out because of more pressing work on the autoguider. They will be performed later. Subsequent photos with the McMullan camera, printed elsewhere in this *Messenger*, have confirmed that this is a telescope of first-rate quality.

1 m Photometric Telescope

The 1 m telescope has been the subject of complaints for a long time regarding image quality and stability. Above all, its performance was erratic and alignment was not maintained. We suspected that most, if not all, these problems were attributable to the state of the prime mirror cell. We were most fortunate in having with us last November Jan van der Ven who had designed this cell fifteen years ago while working at Rademakers in Holland! With his help, it was found that the prime mirror had probably never been correctly mounted in the cell and that certain minor mechanical modifications were necessary to facilitate correct mounting. After 3 days of hard work (including weighing the mirror on a wonderful balance constructed by Jan, to make sure the support loads were set to an optimum) the primary was correctly mounted in its cell and the telescope ready for test during the one available night. Unfortunately, the seeing was rather poor, particularly within the dome due to the disturbance of the day-time work. The centering was done, as before, with pupil plates, but the quality of the pupil plates, even integrated for 4 m, was poor. Also, the judgment of the plates was made more difficult in the N-S direction by a small mechanical vignetting of the pupil whose origin we had no time to trace. Nevertheless, centering within about 0.3 arcsec was still possible. *Figure 5* shows the results. Pl. 3 shows the final centering state after two iterations of correction. Pl. 4 to 7 show results with the telescope inclined in various directions. There is evidence of coma variation in the W plate (zenith distance $\sim 50^\circ$) indicating a small error in the performance of the tube (Serrurier truss); but the astigmatism of about 1.2 arcsec is more serious. The present evidence is that astigmatism appears in a constant direction (independent of telescope azimuth) following the spider on inclining

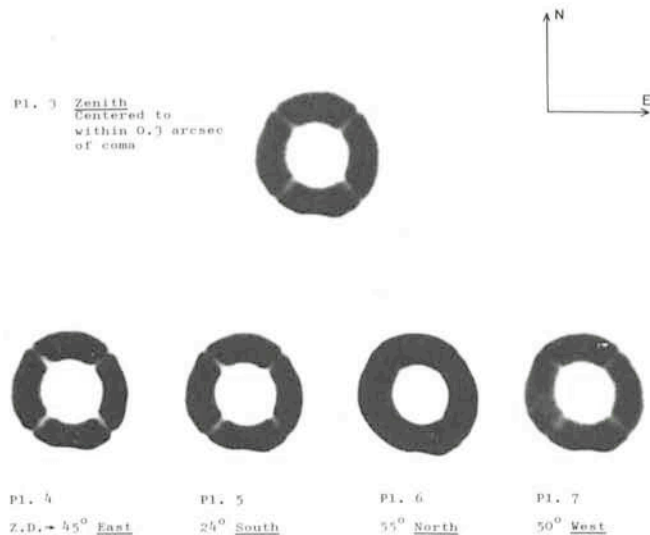

Fig. 5 (ESO 1 m photometric telescope): After centering in the zenith to the quality shown in Pl. 3, the telescope was inclined at the zenith distances shown in the four directions. The pupil plates in the inclined positions show astigmatism up to 1.2 arcsec in the N and W positions and some coma in the W position (Serrurier truss error). (Original image diameter ca. 2.5 mm). Note that both dome turbulence and external seeing were very bad, giving poor quality pupil image. Note, too, the vignetting at the south edge of the pupil.

ANNOUNCEMENT ESO Workshop on Two-Dimensional Photometry

Subjects include microdensitometry of photographic and electronographic plates, panoramic detectors, calibration and data-acquisition problems.

The workshop will take place on 21–23 November 1979 in Leiden (the Netherlands). It is organized by Prof. H. van der Laan (Leiden) and Prof. P. O. Lindblad (ESO-Geneva). Participation by invitation.

Interested persons may contact Prof. Lindblad.

the telescope, but the *amount* increases with telescope inclination. The evidence suggests the cause is in the secondary support but there was no time to investigate this further—we hope to do so next August.

The reproducibility of centering between Pl. 3 and Pl. 8 seems to confirm that the telescope is at last *stable* and maintaining its adjustment. Stability is obviously a sine qua non of satisfactory telescope performance.

1.5 m REOSC Telescope

We had been asked to look at this telescope as well. Unfortunately, the time allotted was in parallel with our 3.6 m time, so we could hardly devote any time or effort to the 1.5 m. Our colleague in Chile, Paul Giordano, did some excellent work checking and readjusting the axial support system of the primary. Some thought was put into improvement possibilities for the unsatisfactory radial support system. There was no time available to mount and try out a new support for the secondary mirrors, intended to provide easier adjustment.

Examination of the image in and out of focus revealed a clear triangular error probably due to the primary radial support and a decentering error apparently varying with focus. The performance seemed stable.

Considerably more time and effort will be needed to get this telescope into an optimum opto-mechanical state.

Conclusion

We have attempted here to give an idea of the work programme for the maintenance and improvement of the optical quality of some of the La Silla telescopes. Our most grateful thanks are due to many colleagues on La Silla who helped us, in particular Paul Giordano and Jan van der Ven, as well as Jan's colleagues in the Mechanical Group. What has been done so far is only a modest beginning: one of us (R.W.) is going to spend a whole year in Chile from next June to pursue the matter with all the telescopes in a more concentrated effort. But it should be remembered that this improvement is only possible if the necessary telescope time is made available. A modest investment in telescope time *now* should save this time many times over in the future by ensuring that astronomers have telescopes functioning as they can and should, giving maximum efficiency use. In general, unreliability of performance or poor quality images cost far more observing time than their systematic correction would require.

Finally, an appeal to our friends, the user astronomers. It will be an immense help and always greatly appreciated if you will contact us directly in Geneva with any comments, suggestions or questions regarding the optical quality of the telescopes on La Silla: you will be helping us to help you!

Recent Observations at ESO of the Dwarf Novae VW Hydri and WX Hydri

R. Schoembs

Observations of the mysterious dwarf novae are being pursued with great vigour at La Silla. In addition to earlier photometric observations (cf. Messenger No. 5, p. 2, and No. 14, p. 15), Dr. Rolf Schoembs of the Institute for Astronomy and Astrophysics at the Munich University (FRG) has now obtained series of consecutive spectra and polarimetric data for two southern, prominent representatives of this stellar class. An early look at the polarimetry enabled Dr. Schoembs to set upper limits for the polarization, and the spectra showed unexpected changes from night to night.

The group of SU Uma-type dwarf novae provides unusual problems for astronomers. Contrary to many other fields of research, where the most urgent task is to improve the quality of measurements, we have very clear and well-established observational facts, but no satisfactory model to explain the observed phenomena in these cataclysmic binaries. The results referred to are in particular the strange changes in the periodic light variations during normal light and superbursts.

One of the most well-known objects, VW Hydri, has a highly constant orbital period $P_0 = 107$ min during minimum light, whereas during superbursts a period of 110 min is observed which decreases quickly, but does not reach P_0 at the end of the outburst. A beat phenomenon is observed when the star is near its minimum. Similar phenomena have been observed for V436 Cen, WX Hydri and Z Cha. Different models have been proposed to explain these facts. Some as-

sume spots on the red component (Warner 1975, Schoembs 1977, Haefner et al., 1978), some assume magnetic accretion poles on an oblique, nonsynchronous rotating or precessing white dwarf (Vogt 1978, Papaloizou et al., 1978). But none of these scenarios is capable of fully explaining the behaviour of all the well-observed objects.

Important information about the existence and, if present, the intensity of magnetic fields can be obtained from polarization measurements. Furthermore, as already shown in the case of Z Cha by Vogt (1978), spectroscopic observations with high time-resolution are of great value for the analysis of the dynamics and for understanding the physical conditions of the main radiation sources in these stellar systems.

Observations with the ESO 3.6 m and 1 m Telescopes

Using the 3.6 m ESO telescope, equipped with the Cassegrain image-tube spectrograph, it was possible to obtain spectra of about 3 Å resolution in only 10 min exposure time of VW Hyi and WX Hyi, at minimum brightness, about 14^m.5. Photometric-polarimetric data in integral (white) light were obtained at the 1 m ESO telescope with a time resolution of 16 sec. The observations started on October 27, 1978 with photometry and polarimetry and continued with spectroscopy from November 4 until November 7.

A preliminary analysis has so far revealed no detectable linear or circular polarization for either of the two objects.

The upper limits in Table 1 are due to atmospheric scintillation and photon noise and therefore increase when the brightness of the object decreases. The detection limits will be considerably improved by statistical computer analysis. The light-curves were deduced from the polarimetric data. For VW Hyi (run 1-3 has not been analysed yet), they show the well-known superhumps and the rates of decrease of the periods were found to be consistent with earlier results.

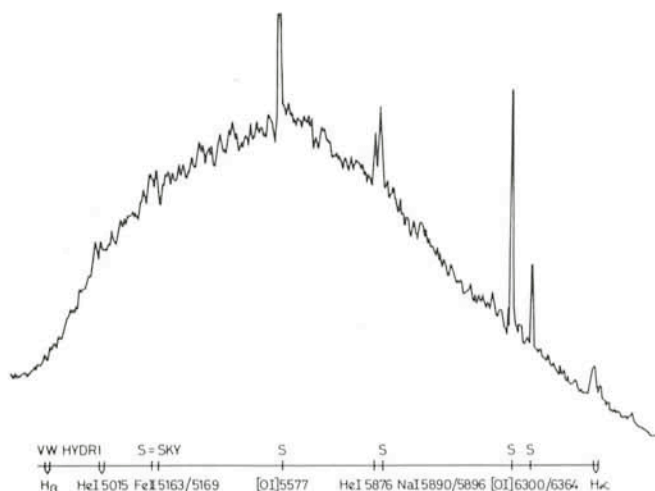

Fig. 1a: Spectrum of VW Hydri taken on November 5, 1978, at 7^h22^m UT.

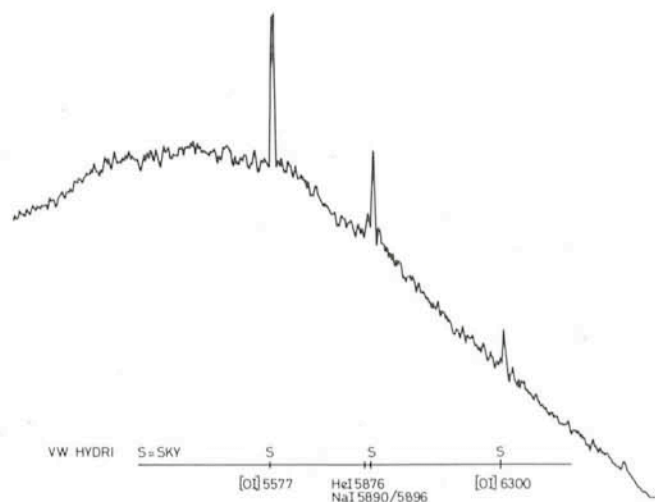

Fig. 1b: Spectrum of VW Hydri taken on November 6, 1978, at 1^h54^m UT.

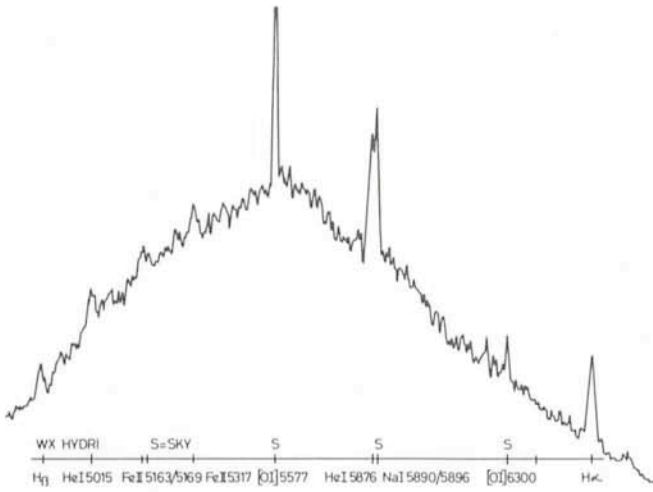

Fig. 2: Spectrum of WX Hydri (November 7, 1978 at 2^h26^m UT).

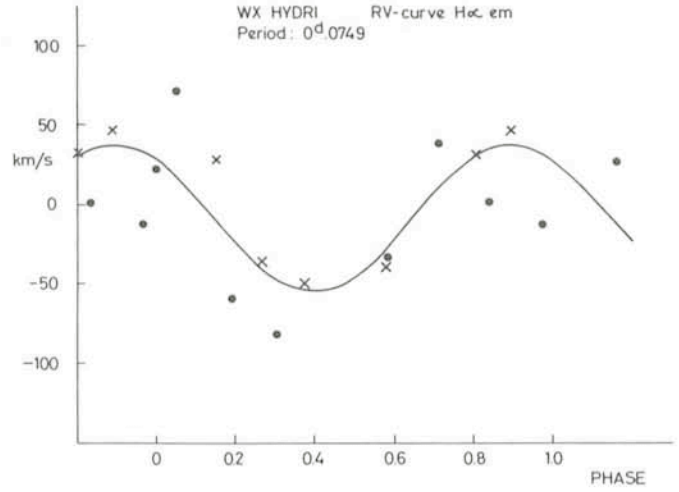

Fig. 3: Radial velocities of WX Hydri from November 7, 1978 folded with a period of 0.0749 day.

Table 1. Polarimetric results

Object	Run	Date	m (white light)	P %	Θ_p	
VW Hyi	4	1978-10-31	9.5	.06 L	random	
	5	1978-11-1	9.6	.08 L	random	
	6	1978-11-2	9.9	.1 L	random	
	7	1978-11-3	10.7	.15 C	random	
	8	1978-11-3	10.7	.15 L	random	
	9	1978-11-4	12.6	.4 L	random	
	WX Hyi	1	1978-11-3	13.2	.5 C	random
		2	1978-11-4	13.4	.6 L	random

L = linear, C = circular polarization.

However, for a final determination, all observations, including those from other observers will be taken into account. A search for high-frequency oscillations will also be carried out.

Strong erratic variations occur in the light-curve of WX Hyi, but no clear periodic feature could be detected which would permit a determination of the orbital period.

The Spectra

The spectral variation of VW Hydri during the superburst is remarkable. At minimum light, broad, double Balmer emission lines were detected by Vogt (1974, private communication). A spectrum taken on October 27, 1978, 3 days after the beginning of the outburst ($m = 9$), showed broad, shallow $H\alpha$ and $H\beta$ absorption lines, as expected from previous results, also by Vogt and from spectroscopic observations of other objects. In a series of 9 spectra on November 5 ($m = 13.3$), $H\alpha$ was a double emission feature, emerging from a shallow and even broader absorption (fig. 1a). He I 5875, 5015, Fe II 5163, 5169, 5316 were also in emission. This suggested that the normal minimum spectrum was already taking over again. But the following night (Nov. 6, fig. 1b), a series of 7 spectra did not show any distinct line feature except very weak He I 5875 emission!

WX Hyi was also declining after an outburst. 15 spectra of the $H\alpha$ -to- $H\beta$ region were obtained within 3.5 hours and showed single emission lines of $H\alpha$, $H\beta$, He I 5875, 5016, Fe II 5817, 5163 (fig. 2). No pronounced intensity or profile variations were found in a first survey. The radial velocities of $H\alpha$

(fig. 3), as measured from the outer edges of the line, fit quite well to a periodic variation of 0.0749 which is half the period proposed by Walker et al. (1976).

These are only a few, early results of the observations. A more sophisticated analysis will undoubtedly reveal more interesting features of these strange objects.

References

- R. Haefner, R. Schoembs, N. Vogt, 1978, ESO preprint No. 33, *Astron. & Astrophys.*, in press.
 J. Papaloizou, J.E. Pringle, 1978, A model for VW Hydri, *Astron. & Astrophys.* **70**, L 65.
 R. Schoembs, 1977, IAU Colloq. No. 42.
 N. Vogt, 1978, *Mitteilungen der Astron. Ges.*, Tübingen, N. 43.
 W.S.G. Walker, B.F. Marino, G. Freeth, 1976, *IBVS* No. 1185.
 B. Warner, 1975, *Monthly Notices Roy. Astron. Soc.*, **170**, 220.

PERSONNEL MOVEMENTS

(A) Staff

ARRIVALS

Geneva

Antonius VAN DIJSSELDONK (Dutch), Optical Laboratory Technician, 1.2.1979.

Leonard OOSTRIJK (Dutch), Senior Software Specialist, 5.2.1979.

DEPARTURES

La Silla

Sölve ANDERSSON (Swedish), Electronics Technician, 28.2.1979.

(B) Paid Associates – Fellows – Coopérants

ARRIVALS

Geneva

Hernan QUINTANA (Chilean), Paid Associate, 1.3.1979.

La Silla (Scientific Group)

Jan LUB (Dutch), Fellow, transferred from Geneva, 1.1.1979.

Great Expectations

J. H. Oort



Professor Jan H. Oort from the Leiden Observatory in the Netherlands is one of the founders of ESO and one of the most ardent supporters of collaboration in European astronomy. We are extremely pleased to bring his comprehensive views on the utilization of the VLT. During many decades of active front-line research in astronomy, Professor Oort has inspired numerous programmes and astronomers. We trust that the readers will share his enthusiasm for what the VLT can contribute to cosmology!

The Very Large Telescope of the future raises great expectations for cosmologists. For might it not provide answers to two fundamental questions:

I. In which era of the Universe were the majority of the galaxies formed, and in which era the majority of galaxy clusters? Were the galaxies there prior to the clusters, or did they condense as a consequence of the cluster formation? And what place have the quasars in this?

II. What is the radius of curvature of the Universe?

Evolution in the Universe: Radio Galaxies and Quasars

The discovery by Ryle and his collaborators of the excess density of faint radio sources which revealed that the space density of radio sources increases strongly when looking back in time, and the subsequent confirmation and specification of this density increase by means of quasar redshifts



A small area of Red Survey plate No. 3073, obtained with the ESO Schmidt telescope in November 1978. Exposure time 120 min on hypersensitized IIIa-F emulsion behind a RG630 filter. Several galaxy clusters are seen. Note in particular the very distant cluster in the lower left corner.

by M. Schmidt and others have shown that their population density increases with the redshift z as approximately $(1+z)^6$. At $z = 2$ the number per co-moving volume (i.e. a volume of which the radius contracts by a factor $1+z$) is of the order of 10^3 times that in our vicinity. As quasars are short-lived their birth rate at $z = 2$ must have been higher by the same factor. The rapid increase seems to come to an end between $z = 2$ and $z = 3$. The largest redshifts known today are around $z = 3.5$. The fact that no larger redshifts have been found may indicate that they are indeed rare, though it is not yet clear how much of this scarcity is caused by observational limitations.

Two important new data have recently appeared on the evolution front. The first is the evidence that ordinary radio galaxies (non-quasars) show a similar increase in number density with z as the quasars, or perhaps an even stronger one. This was found from deep optical identifications of very weak sources. An interesting circumstance is that they show this strong increase already at relatively small distances.

The second interesting observation is that the colours of many parent galaxies of radio sources seem to be considerably bluer than those of other elliptical galaxies. If this is confirmed it may indicate that many of the distant radio galaxies are young systems. Alternatively, they might be old systems showing a burst of star formation. It should be mentioned that similar blue colours have recently been observed in two distant galaxy clusters which are not known to be connected with radio sources.

Quasar and Galaxy Births

The first question which arises is whether the births of quasars and radio galaxies are connected with the births of galaxies.

It is not implausible to assume that quasars form as a result of the collapse of a protogalaxy or of the evolution of a dense stellar core in a young galaxy. As a strong central concentration and a large mass would seem to be necessary conditions, one would expect to find quasars connected with giant elliptical or N galaxies. But it is also conceivable that the production of a quasar could be a repeating process, such as we observe in some radio galaxies; however, the observed rapid decline in quasar frequency below $z = 2$ is a strong indication that after the era $z \sim 2$ galaxies rapidly lose their ability to make quasars.

We must envisage two possibilities: either the parent galaxies of quasars were largely born around $z = 2$, or they were formed in an earlier era, and it was only around $z = 2$ that conditions within them became favourable for the formation of a quasar or the development of strong radio emission. As long as there is no indication why this could have happened at a more or less arbitrary time in the life of a galaxy, the first possibility appears more attractive.

I assume that the life time of a quasar is short compared with the age of the Universe and that therefore the number density at a given z is a measure of their birth rate at that z . The radio *galaxies* will have longer lives, but still rather shorter than the age of the Universe, otherwise they could not show the observed increase in number density. A comparison of the density increase of radio galaxies with that of quasars might give an indication about their life times. For small z their density should rise more steeply than that of the quasars. Indications of such an effect have indeed been found. Because *clusters* of galaxies have very long lives, they would not be expected to show an appreciable change in number density with z . However, *their* history and evolu-

tion is likely to be largely determined by other factors beside the birth rate of galaxies.

In this note I adopt as a working hypothesis that the number density of quasars is proportional with the birth rate of giant elliptical galaxies. This is certainly oversimplistic, and the observations will undoubtedly show that the hypothesis is inadequate. But it may nevertheless serve to suggest which observations are crucial, and to give an impression of what they might yield.

Clusters of Galaxies

One way in which we might possibly find out more about the character and the manner of formation of quasars and radio galaxies is to investigate whether they are members of groups or clusters of galaxies. If they are, their relatives in these formations may give new information on their distances and in particular provide data on *ages*.

In the case of the radio *galaxies* we know that a large fraction does lie in clusters. Moreover, for the radio galaxies the age problem can be tackled more directly, because the parent galaxy itself can be observed. As mentioned above, it has recently become possible to do this down to very faint limits, up to $z \sim 0.5$.

For optical investigations into the still more distant past the quasars are the obvious sign posts. They are at present the only objects which we can observe at the time where on our working hypothesis maximum star formation would have occurred.

Except for the increase in number density with increasing z our knowledge of the evolution of quasars is very scant. It is largely confined to statistics of the redshifts of their absorption spectra. It is conceivable that more detailed optical and radio studies will yield criteria to distinguish quasars of different absolute magnitude. This would evidently be of tremendous value, as it might lead to a direct determination of the radius of the Universe. I return to this in the last section.

It would, of course, be of primary importance to know more about the systems in which quasars are located. Kristian and others have shown that the quasars for which $200''$ plates could be expected to show the light of the underlying galaxy *did* show such a galaxy. But there are as yet no data that give convincing evidence concerning the type of the galaxy or its age. Especially the latter is important in connection with our working hypothesis. But in view of the difficulty of separating the bright quasar image from that of the surrounding galaxy it seems unlikely that much information could be obtained from ground-based telescopes. I therefore omit this from my list of observing programmes.

Are Quasars in Clusters of Galaxies?

A programme better adapted for the VLT would be the search for galaxies associated with the quasars through their common membership in a cluster or group, and the study of their types and colours.

At present little is known about the connection between quasars and clusters. As the more nearby quasars (with $z < 0.5$) have visual absolute magnitudes between about -24 and -28 (if we assume a Hubble constant $H_0 = 75 \text{ kms}^{-1} \text{ Mpc}^{-1}$) while the first-ranked cluster galaxies have -22.1 on the same scale, we should expect to find a few galaxies at magnitudes between 2^m and 6^m fainter than the quasar if the quasar would be situated in a regular cluster. Generally such a cluster would contain some 20 members in an interval of $1^m.5$ below the brightest member, i.e. to a limit roughly 5^m

fainter than a quasar of $M_V = -26$. As quite a number of quasars are known with $m_V \leq 16.0$, and as searches for clusters must have been made, it is somewhat surprising that only two cases of clusters around quasars have been reported. Stockton (*Astrophys. J.* **223**, 747) has, however, recently reported that in a search around 27 quasars with $z < 0.45$ he has found from 1 to 3 galaxies with a redshift corresponding with that of the quasar in the vicinity of 8 of them.

Further investigations are evidently required before one could conclude that quasars are less commonly associated with clusters than supergiant elliptical galaxies in general. It is an important problem and should well repay a programme with the VLT. I assume, somewhat arbitrarily, that with this telescope it will be possible with special effort to detect galaxies down to $m_V = 24$. The estimate is based on the results of recent optical identification programmes of weak radio sources with the Kitt Peak 4 m reflector, in which galaxies were found down to $m_{pg} = 23$. If a large fraction of the quasars are in clusters the VLT should make most of these clusters observable, and should even enable astronomers to make fairly extensive colour measurements. In this way it may well be possible to determine whether the galaxies in these clusters are as young as the quasars are supposed to be on our working hypothesis.

Suggested Programmes

On the basis of the above considerations the following programmes are suggested:

1. Optical identifications in at least two wavelength bands of radio sources down to the faintest attainable radio limits, and search for evolution effects in the galaxies identified with the sources.

1a. Rough determinations of redshifts for a few of the faint galaxies, for verifying the absolute magnitude calibration.

2. Searches for galaxy clusters around the identified galaxies.

3. A search for clusters around quasars (again at at least two wavelengths).

4. A search for distant clusters containing *no* radio sources, in order to investigate how *their* number density varies with z . On our hypothesis it should not vary in a way comparable to that of the quasars.

(1) A recent investigation (H.R. de Ruiter, doctor's thesis Leiden, 1978; cf. also *Astron. Astrophys. Suppl.* **28**, 211) has shown that with special efforts observations with the Kitt Peak 4 m telescope can reveal galaxies as faint as the 23rd photographic magnitude, and that, with this limit, 47 % of all radio sources stronger than about 5 mJy at 1415 MHz could be identified, and that even at the fainter magnitudes galaxies could be distinguished from point sources. The percentage of optical identifications increases rapidly with the limiting magnitude and the scale of the plates. On Palomar 48" Schmidt plates with a limiting magnitude of 22^m.5 it was only 23 %. The VLT should certainly go considerably deeper than the Kitt Peak telescope. If we assume that with special recording techniques it may reach $m_V = 25$ or 26 it will probably make possible the identification and colour measurement of nearly all radio sources found in the deep surveys.

(2) According to Sandage the average visual absolute magnitude of powerful radio galaxies is $\langle M_V \rangle = -21.6$ with a dispersion of ± 0.44 (for $H_0 = 75$). As a first-ranked cluster galaxy has $\langle M_V \rangle = -22.1$, and a score of the brightest members of a cluster should have M_V brighter than ~ -20.5 , it should be possible to discover clusters around at least the brighter half of the identified radio galaxies. The stage of

evolution of the cluster could then be studied from measurements at two or three wavelengths.

(3) Should evidently be started with quasars at small redshift. If the quasar is situated in a cluster several dozen members should be observable for redshifts smaller than 0.5. Hopefully, clusters might even be discovered at redshifts as large as 1.0. It is clear that a negative result would also be valuable and intriguing.

(4) A systematic survey down to $m_V = 25$ of, say, 100 square degrees might well yield a sizeable number of clusters to well beyond $z = 1$.

Intrinsic Brightness Criteria for Quasars and the Radius of the Universe

I imagine that at the time the VLT would come into operation this might well be the subject that should have highest priority. Detailed spectroscopic data would be likely to be an important asset, but the few indications that have so far been found give no sufficient basis for outlining a programme at the present time.

Conclusion

If I were at present to obtain 10 nights with a VLT I would propose to spend 5 nights on programmes 1 and 2. With two hours for each object (in two wavelength bands), 5 fields might be observed per night, or perhaps 20 in total if 1 night would be reserved for 1a. This is entirely insufficient for the statistical data required, but it could serve as a pilot programme for later, more extensive, observations.

The remaining 5 nights I would devote to project 3, again in the nature of a pilot programme.

Because it would be necessary to distinguish extremely faint and small galaxies from stars, good seeing and dark nights would be absolute requirements.

NEWS and NOTES



Was it Really a Comet?

Most comets found by professional astronomers are first seen as a diffuse trail on a photographic plate.

In the middle of December 1978, astronomer Richard West of the ESO Sky Atlas Laboratory in Geneva was checking a lot of deep, red plates from the Schmidt telescope on La Silla when he discovered what appeared to be the trail of an 18th magnitude comet. Since the plate in question was taken a fortnight earlier, control plates were immediately obtained in Chile at the extrapolated positions (the direction of motion was not known from the trail).

To some surprise, no comet was seen on the additional plates. There are only two explanations: either the comet had become too faint to be photographed, or the trail was a "plate fault" in the emulsion. The first possibility cannot be ruled out and the second may be less likely because of the well-defined trail and the attached "tail". We shall probably never know the correct answer.

More High-Quality Observations Of Stellar Spectra

L. Houziaux

With its large light-gathering power, the VLT will permit spectra of even rather faint objects to be obtained with short exposure times. It will therefore become possible to observe rapid changes in, for instance, the emission lines in nova spectra and to learn about the physical conditions of a nova outburst. Professor Léo Houziaux of the Astrophysical Institute in Liège, Belgium, expects to observe spectrally variable stars with the VLT and also to do very accurate spectrophotometry of a number of brighter stars.

Looking at the increase of observing time devoted to extragalactic astronomy with existing large telescopes, it is very likely that most of the nights with a VLT will be awarded to programmes concerned with the structure and evolution of galaxies, quasars or BL Lacertae objects. This trend is quite justified as most of the exciting features in contemporary astronomy arise from the study of such objects.

The main advantage of the VLT will be its high light gathering power. It should be remembered, however, that the limiting magnitude for such an instrument is much depending on its focal length and on the quality of seeing. On the other hand, we do not have at present much experience on the optical image quality of multi-mirror systems. It is clear that the brightness of the "dark" sky will be more and more disturbing as the diameter of the telescope increases. Therefore the wavelength ranges for most favourable observing conditions should be carefully studied, and the remaining part of the spectrum should be left for instruments on board of satellites or space stations. Certainly the use of a VLT has to be considered in correlation with other ground-based or space instruments.

Variable Emission-Line Objects

If I were granted ten nights at the VLT, what would I observe? In fact, I think this is a fairly unrealistic question, since I can see no way of being granted such a long observing run by any institution without having submitted for quite some time a detailed proposal! If the instrument would be available now, I would write an application for making spectrographic observations of short time-scale variable objects. High time and spectral resolution observations of novae and other variable emission-line objects would be very valuable. We know that the light variability of novae exhibits short periods, but we do not have at present numerous series of correlated spectral observations. We suspect that the shell around a nova develops in a short time and we should try to measure its acceleration during this early phase. How is this acceleration connected with the overall luminosity variations? When do the various shell absorption lines arise? How does the line structure change with the position angle of the spec-



trograph slit? What happens to the line profiles during the transition phase? Numerous observations of Nova Aquilae 1918 have shown that there is considerable asymmetry in the distribution of emitting material. The VLT should permit short exposures to be made, revealing at the early phases these asymmetries as well as anisotropies in the velocity field. Speckle interferometry techniques might be most useful for such purposes. On the other hand, it should be possible with the VLT to continue the observations until the object has become quite faint and reached its minimum brightness.

In summary it can be said that careful observations of a nova outburst with a VLT would bring us important information on the development of the shells especially at the early stages and hence clarify the understanding of the nova phenomenon. Along the same lines, I would be curious in obtaining spectra of intrinsic variables for which the spectrum is known at present only at maximum of light. Spectrograms of such stars at intermediate phases and at minimum of light may reveal what makes these objects fade out rather suddenly (emission of stellar material, increase in the opacity of the atmosphere?) For such an investigation, one would hope that much attention be given to the appropriate instrumentation which might reveal itself as important as the light gathering power of the telescope. But it is most unlikely that I could spend all the dark hours each night on a nova or on a peculiar variable star.

Accurate Spectrophotometry of Bright Stars

So I would like to use a part of the night for observing with great accuracy the profiles of certain lines even in moderately bright stars. A high signal-to-noise ratio may be reached even with photographic plates if a sufficient number of spectra is secured. An accuracy of 1 per cent in intensity seems to be a reasonable goal to achieve. Therefore, one would hope that adequate auxiliary instrumentation will be provided with the VLT and that all the characteristics of such an instrumentation will be available to the observer well in advance of his observing run. Appropriate data handling and reduction will be important items and should also be available to the guest astronomer. If the VLT were available for describing the spectra of a fair number of brighter stars with an accuracy of 1 per cent over the spectral range 3000 Å to 9000 Å it would help a great deal in solving current problems in the field of stellar photospheres and external atmospheres.

The Mysterious Elliptical Galaxies

F. Bertola

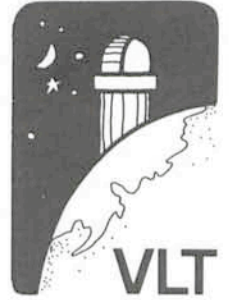

Until recently, most astronomers agreed that the elliptical galaxies were very well understood. Then, a few years ago, evidence was found that their ellipsoidal shapes cannot be explained as a flattening by rotation alone. Some even seemed to be prolate, i.e. extended in the direction of the poles! This problem, of cosmological significance, has been studied by Dr. Francesco Bertola at the Astronomical Institute of the Padova University (Italy) and his collaborators. Needless to say, one of the problems he would like to investigate with the VLT concerns these strange galaxies.

The Shapes of Elliptical Galaxies

A very large fraction of the observing time will be devoted to the study of the structure and dynamics of elliptical galaxies. During recent years several observations have led to a dramatic change in our view of elliptical galaxies. The unexpected, very low velocity of rotation that is found even in apparently flat systems (Bertola and Capaccioli, 1975, Illingworth, 1977) as compared with the velocity dispersion, has contradicted the previous theoretical models, attributing the flattening to rotation only.

More complicated models suggesting a triaxial or prolate configuration have been proposed for elliptical galaxies. An important aim of future observations should be to provide evidence in favour or against them. Detailed surface photometry of elliptical galaxies with high spatial resolution will allow the study of phenomena like the twisting of the major axis of the isophotes and the variation of their ellipticity in the innermost parts. These phenomena could be related to a triaxial structure, but their presence is not a necessary condition for such a structure, because of the dependence on projection effects. Consequently, the nature of this study is somewhat statistical and requires observations of a large number of galaxies.

My approach in preparing a programme for ten nights of observations with the 25 m VLT telescope consists in considering the limitations I am facing in my current research which is carried out with the largest telescopes presently available. The main constraints are now spatial and spectral resolution and the detection of faint signals against the sky background. Hopefully, the very large collecting power of the VLT, coupled with up-to-date auxiliary equipment and sophisticated data-processing techniques will contribute to overcome at least part of the present limitations. The observing programmes I am proposing reflect my current interest, but they take advantage of the high performance of the VLT.

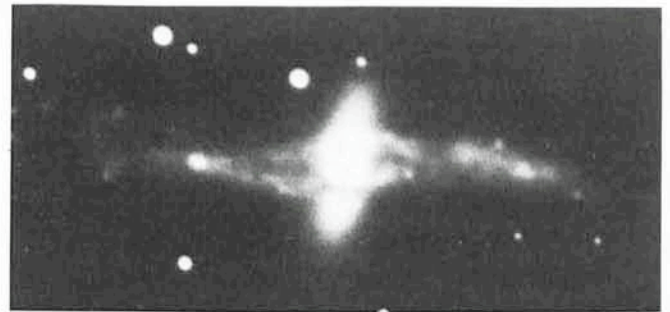

Possible prolate structures in the galaxies NGC 5128 (upper left) and NGC 4650A (upper right) as compared with an oblate spheroidal component superimposed on a disk in normal galaxies NGC 4565 (lower left) and NGC 4594 (lower right). NGC 5128, 4650A and 4594 were reproduced from 3.6 m photos (observer Dr. S. Laustsen) and NGC 4565 was photographed with the Palomar 5 m telescope.

The VLT will be able to observe the galaxies of the Coma and Perseus Clusters in the same detail as today's instruments observe the Virgo Cluster. In order to get a complete picture of elliptical galaxies, the photometric study has to be coupled with detailed dynamical analysis. The large scale of the telescope and sophisticated detectors covering the whole image of the galaxy will allow complete mapping of the velocity field and velocity dispersion, and thus provide a way to discriminate between different models. Triaxial models, for instance, do not require zero velocity gradient along the apparent minor axis, as in the oblate case.

All these observations require high spectral resolution. Since we already know the very peculiar behaviour of the luminosity profile and of the velocity dispersion in the nucleus of M 87 (Sargent et al., 1978) a proposal entitled: "A search for black holes in the nuclei of elliptical galaxies" seems to be a very appropriate one for the VLT, particularly if black holes continue to be fashionable as they are now.

Interesting cases to be studied are the elliptical-like galaxies which are rich in dust and gas, often radio sources, which Bertola and Galletta (1978) have recently proposed to possess a prolate configuration (i.e. extended in the direction of the poles). Unfortunately there is only one galaxy of this kind, namely NGC 5128, which is close enough to be studied in detail with present telescopes. In order to understand the way in which these galaxies formed and their correlation with other types of galaxies, it is of great interest to study both the dynamics of the gas and of the stellar component.

Stars in Elliptical Galaxies

Finally, being always confined to elliptical galaxies, a "Study of the stellar population in the nuclei of elliptical galaxies"

would be another programme requiring high spatial and spectral resolution. We are at the present moment collecting some evidence that the stellar content in the nuclear parts of ellipticals could differ drastically from the rest of the galaxy. Very recent observations (Bertola and Capaccioli, 1979) in the UV show that in the nucleus of the giant elliptical galaxy M 87 the energy distribution is increasing towards short wavelengths as a black body with a temperature of 30,000°K. The interesting fact is that the phenomenon is not just concerning the stellar-like, central source in M 87, but the whole innermost nuclear region, indicating a peculiar stellar population in the nucleus of M 87. Is this phenomenon characteristic of active galaxies only? Is star formation occurring in the nuclear regions of the ellipticals? This is an example of the questions that detailed spectrophotometric studies carried out with the VLT could answer.

There is of course the possibility, which is highly desirable, that at the time the VLT enters into operation, most of the problems envisaged in this article have already obtained a satisfactory explanation. But in the meantime, new and perhaps even more complicated problems will have arisen and the VLT will be a powerful tool for solving them.

References

- F. Bertola, M. Capaccioli, 1975, *Astrophys. J.*, **200**, 439.
- F. Bertola, M. Capaccioli, 1979, in preparation.
- F. Bertola, G. Galletta, 1978, *Astrophys. J.*, **226**, L 115.
- G. Illingworth, 1977, *Astrophys. J.*, **218**, L 43.
- W. L. W. Sargent, P. J. Young, A. Boksenberg, K. Shorridge, C. R. Lynds, F. D. A. Hartwick, 1978, *Astrophys. J.*, **221**, 731.

The VLT and the Infrared

J. Borgman

The use of the VLT will not be restricted to the visual region of the spectrum. One of the great advantages of the large size will be the greatly improved angular resolution in the infrared. Professor Jan Borgman of the Groningen University (of which he is Rector) has since long been active in infrared astronomy. He explains how the VLT can be used to study cool objects and possibly contribute actively to the search for life in the Milky Way.

Larger telescopes have more light-gathering power and can do some jobs of smaller telescopes in less time. In the same observing time a 25-m dish will reach 3.5 magnitudes deeper than the 200-inch, as long as background saturation can be ignored. Such merits of large dishes are obvious; undoubtedly some time on the VLT will be given to programmes which have to push the limiting magnitude in order to reach more distant and/or fainter stars.



However, I would expect that the Observing Programmes Committee would favour proposals which really require the use of the VLT and which have contributed to the justification of the initial investment. In this class are some applications of the angular resolution capabilities of the VLT in the infrared, which can be favourably exploited with an infrared camera.

Infrared Cameras

With available techniques an infrared camera picture has to be synthesized from observations with arrays of a modest number of discrete detectors. However, it is certain that the future will offer multiple element targets with high resolution capability. The VLT has diffraction-limited images of 0.2 arc-seconds at the 10 μm diffraction limit in a field of 10 x 10 arcmin² (reasonably assuming that a fully corrected field of 15 arcmin diameter is available). We need 10⁷ picture elements in order to get diffraction-limited resolution over this

field. Speckle interferometry techniques are needed to restore the picture at the resolution of the diffraction limit. An auxiliary instrument in combination with the necessary data management and storage power can safely be assumed to be available before the end of the 1980's.

Objects to be included in the observing list are those which are likely to be resolved at the available angular resolution. E.g., at the distance of the galactic centre an opaque nebula of 0.2 arcsecond diameter and at a temperature of 300°K represents a luminosity of $10^5 L_{\odot}$. This means that we might recognize the more massive stars in their early phases of evolution as far away as the galactic centre, without being bothered by interstellar extinction.

In the nearest galaxies, e.g. at a typical distance of 1 Mpc, the VLT can resolve opaque structures of $10^9 L_{\odot}$ at 300°K while observing at 10 μ m. This resolvable luminosity can be reduced by a factor of 100 if a coherent array with a 250 m base line were installed rather than the 25-m single dish VLT.

The Observations

After this introduction it is clear what I would do: take infrared pictures of the galactic centre, several H II regions with compact knots, and the nearest galaxies. These ob-

servations would be followed up by measurement of some infrared spectral features like the "ice" band at 3.1 μ m and the "silicate" feature at 9.7 μ m (or should we, following Hoyle and Wickramasinghe, speak of cellulose and chlorophyl?). Energy balance and radiation transfer models now being proposed for infrared sources require actual dimensions or new upper limits to the diameter in order to test or refine the models. It is likely that a ground-based VLT or an array of smaller telescopes is the only answer to this problem.

The question of life in the universe is going to become a spectacular and challenging topic in the next decades. A search for (precursors to) life, either in interstellar space, in cool circumstellar clouds, in warm interstellar clouds or on nearby giant planets could be supported by the VLT and its high resolution infrared camera and spectrometer. It is clear that such programmes require a joint approach with radio astronomical studies of molecular lines.

One final word about the actual observations: rather than being given 10 nights at the VLT I would hope that also the day time is available. A team of at least three astronomers or subteams is necessary to bring in the rich harvest that can be expected from using the VLT and the advanced auxiliary instruments during "my" run of 10 "nights" at the VLT.

NEWS and NOTES

Joint IUE-ESO Observations of Binary X-ray Sources

In April 1978 a joint international observing programme of X-ray binaries started with IUE. The initiative to start this international collaboration dates back to 1975 when, on the invitation of R. J. Davis and A. K. Dupree of Harvard University, groups around the world decided to "pool" their observing time with IUE, in order to achieve an as complete coverage as possible of some of the most important X-ray binaries.

The sources involved in this cooperation are Cygnus X-1, Hercules X-1, Scorpius X-1 and Vela X-1. Other sources are studied by groups individually or in smaller collaboration. Four groups in the U.S. and three European groups (R. Wilson, A. Willis from University College London, E. van den Heuvel, H. Lamers and C. de Loore from the Universities of Amsterdam, Utrecht and Brussels, and A. Treves, E. Tanzi and M. Tarengi from Laboratorio di Fisica Cosmica, Milano) take part in this collaboration.

Two weeks of observing time were allotted by the three space agencies involved (NASA, ESA, SRC) to this collaborative programme: one week from April 27–May 4 and another week from July 9–July 16, 1978. Most of the known X-ray binaries were observed during these periods. Thanks to a timely organizing effort of the observers, simultaneous observations of the objects were organized in X-rays and from the ground. For some sources observations were made from the X-ray to the infrared wavelength region.

For the X-ray observations the Leicester Sky Survey instrument aboard Ariel-5 and the UCL experiments aboard the Ariel-5 and Copernicus satellites were used. Also several groups have put as much effort as possible in obtaining simultaneous ground-based observations. During the 2 weeks of IUE observations, ESO allotted observing time to C. de Loore and M. Burger from Brussels. De Loore observed the brighter X-ray binaries with the coude and the fainter ones with the Echelec spectrograph attached to the 1.5 m ESO telescope, whereas M. Burger used the 1 m telescope for photometric UB_v and uvby_β observations of the same sources. At

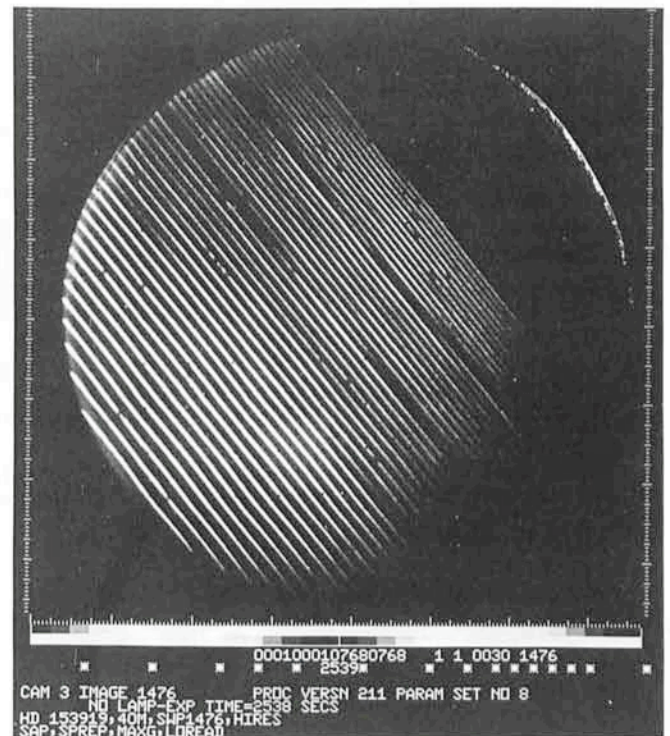

Fig. 1: Photograph of the short wavelength, high dispersion IUE spectrum of the X-ray binary 4U1700-37/HD153919, obtained by G. Hammerschlag-Hensberge at the Villafranca ground station near Madrid. The broad P-Cygni profiles of UV resonance lines are indicative for a strong stellar wind.

the same time D. Morton and P. Murdin observed the sources with the Boksenberg image photon-counting system at the Anglo-Australian observatory in Australia. J. Menzies and P. Whitelock used the 74 inch and 40 inch telescopes at the Cape Town South African Astronomical Observatory also for spectroscopy and photometry in the visible wavelength region. Infrared observations were made

at Tenerife with the 1.5 m Flux Collector by P. Meikle of the Imperial College London.

Thanks to this big international effort we were able to combine observations in different wavelength regions of each source and to study possible binary phase dependent variations in these binaries, a study which would not have been possible without this collaboration. At this moment we can already say that the collaboration has been successful and the first results of the reduction of all this material nears completion. We certainly hope to continue this collaboration in future. *G. Hammerschlag-Hensberge*

A Compact Group of Galaxies: Klemola 25

The cluster Klemola 25 was discovered by A. Klemola in 1969 and was included in a recent general study of nearby clusters of galaxies. A 3.6 m prime focus plate (fig. 1), shows this remarkable, compact group of galaxies. At first sight it is not unlike a more distant version of Stephan's Quintet. The four central galaxies form a tight circle, approximately 3 arcmin in diameter.

Three of the galaxies are clearly ellipticals and the fourth appears to be a barred spiral, its spiral arms stretching around the two nearest members. Two small galaxies can be seen outside the group. The lower one appears to be an edge-on spiral, and the other an elliptical.

Spectra taken with the IDS at the ESO 3.6 m and with the Carnegie tube spectrograph at the CTIO 4 m show all the galaxies, unlike Stephan's Quintet, to have similar velocities of about $15,000 \text{ km s}^{-1}$. Adopting $H_0 = 55 \text{ km s}^{-1} \text{ Mpc}^{-1}$, this puts the group at a distance of approximately 270 Mpc. The group diameter is therefore roughly 230 kpc. The cluster, besides having a striking appearance, is then incredibly compact and certainly worthy of further study. *Anthony C. Danks*

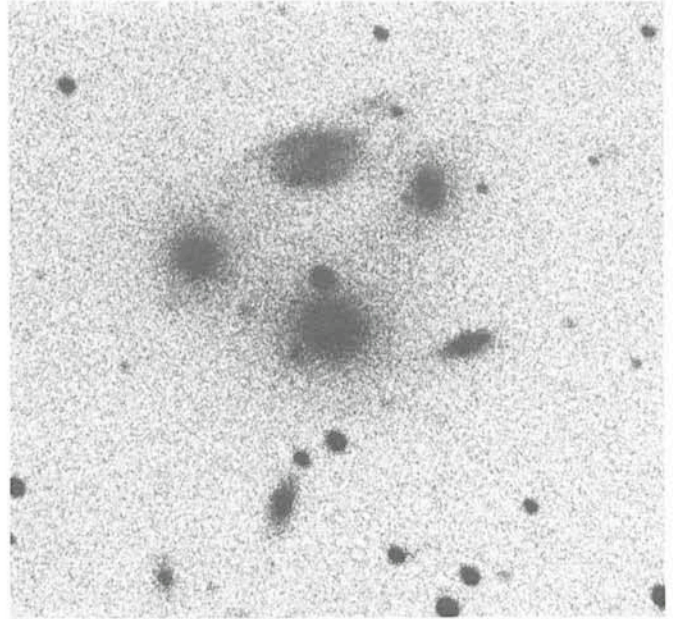

Fig. 1: This plate of the group of galaxies Klemola 25 was obtained by Dr. Danks at the prime focus of the 3.6 m telescope on 103a-O emulsion behind a GG 385 filter. Plate No. 1565, exposure time: 60 minutes.

Correction

A photo of a galaxy field in which a supernova had been discovered was shown on page 24 in *Messenger* No. 15. The scale was wrongly indicated. It should have been 1 arcmin/cm.

European Astronomers Discuss the Use of the Space Telescope

A workshop on "Astronomical Uses of the Space Telescope" was held in Geneva on February 12-14, 1979. This workshop was organized jointly by ESA (European Space Agency) and ESO and took place in the main auditorium at CERN.

The Space Telescope is a telescope of 2.4 m diameter which will be placed in orbit in late 1983 by the Space Shuttle. The telescope will be, at least during the first years, dedicated to observations between 1100 \AA and 10000 \AA . For the astronomer, the most important parts of the telescope are the spectrographs, the cameras and the photometer which will be placed on board. These instruments will make it possible to carry out observations which are absolutely impossible to do from the ground: observations in the ultraviolet and observations with an angular resolution of $\sim 0.1 \text{ arcsec}$. From the ground it is not possible to observe with an angular resolution better than 1 arcsec, not because of the telescopes, but because of the atmospheric turbulence.

The possibility of observing in the ultraviolet has several advantages: (i) it nearly doubles the range of wavelengths where precise spectrographic observations can be made, (ii) it permits to measure the intensity and profile of lines in the ultraviolet which are very important for our understanding of various objects, like, for instance, stars, gas clouds

and Seyfert galaxy nuclei, and (iii) it increases the contrast between a normal stellar population and the high-frequency non-thermal radiation often emitted by galaxies which are radio emitters.

The possibility of observing with a high angular resolution permits to study structure on a scale 10 times better than from the ground. However, the most important of the characteristics of the Space Telescope is that, with its cameras, it will be possible to see objects which are one hundred times fainter than those that can be observed with the best ground-based telescopes. This has obvious advantages for the study of stars, nearby galaxies, etc. . . . but above all it will permit to explore and study the Universe at distances 10 times larger than can be done now from the ground.

There will be two cameras on the Space Telescope. One is the *Wide Field/Planetary Camera* which will be equipped with the most efficient detector: a charged couple device or CCD, and it will be optimized to have the largest field possible and still have the good angular resolution of 0.1 arcsec. The other camera, the *Faint Object Camera*, is optimized to use the ultimate angular resolution of the Space Telescope and therefore to detect and to measure the faintest objects. An important feature of this camera is that a portion of the

field that is isolated by a slit of dimensions 1 x 0.1 arcsec can be observed with a grating. With this long-slit spectrograph it will be possible to observe nearly one hundred adjacent regions at a time. This advantage is not shared by the two other spectrographs on board because, being equipped with linear detectors—instead of two-dimensional detectors like the cameras—they can see only one region at a time.

One of these two spectrographs is designed for a high wavelength resolution study of relatively bright objects whereas the other will give medium to low wavelength resolution on faint objects. The photometer is designed to give the possibility to measure extremely rapid flux variations; variations on time scales as small as 20 microseconds will be detected; such observations are completely impossible from the ground because of the turbulence of the atmosphere.

The Space Telescope is built jointly by NASA and ESA. Among the scientific instruments, ESA is responsible for the design and construction of the Faint Object Camera. The ESA astronomers will have at least 15 % of the observing time on the Space Telescope and will be able to use any of

the instruments on board for their observing programmes.

There were several reasons to hold a workshop on the Space Telescope at this time:

First, make people aware that the Space Telescope is a reality for the European astronomical community and present technical information on the instruments. Second, start a discussion of a number of astrophysical problems of current interest, taking into account the new types of observations which will soon be possible. Hopefully these discussions will continue among astronomers back at their home institutions and result in identification of the important problems which can most benefit from Space Telescope observations. Moreover, these discussions will help in deciding which ground-based observations should be done between now and 1983 in preparation of the Space Telescope observations. Third, a workshop is a meeting place where discussions start and develop but also where collaboration between astronomers or groups of astronomers is initiated.

The Proceedings of the Workshop are now being edited and should be available before the summer. The next issue of the *Messenger* will bring more details about the outcome of this important meeting.

M.-H. Ulrich

Instrumentation Schedule

This is the up-dated time schedule for the major instruments which are being developed at ESO in Geneva for use on the 3.6 m telescope. See also *Messenger* No. 15, p. 10.

Triplet Adaptor (M. Tarenghi, M. Ziebell). Target date: June 1979. The components are:

- two 3-lens correctors for prime focus
- an adaptor with tv for acquisition and guiding
- a remote-controlled shutter and changer for 4 filters
- a remote-controlled changer for 8 plates (3 magazines); plate size is 240 x 240 mm.

More details are published on p. 26 of this *Messenger*.

4 cm McMullan Camera (W. Richter). Target date: October 1979. – Electronographic camera as developed by McMullan. Can be used behind triplet adaptor in prime focus.

Coudé Echelle Scanner (CES) (D. Enard, J. Andersen [Copenhagen], A. Danks). Target date: mid 1980.

- Instrument to record very high resolution digital spectra (up to 100,000) on a 1876-channel-DIGICON detector. Double-pass scanning mode permitting calibrations on bright objects with very clean instrumental profile.

For more details see p. 37 and *Messenger* No. 11.

Coudé Auxiliary Telescope (CAT) (T. Andersen, M. Deneffeld). Target date: mid 1980.

- 1.5 m spectroscopic telescope feeding CES of the 3.6 m telescope. Three-mirror alt-alt telescope with f/120 (f/32 after focal reducer). Dall-Kirkham optics with spherical secondary. Direct drive servos without gear.

For more details see *Messenger* No. 10.

Infrared Top-End (R. Grip, P. Salinari). Target date: mid 1980.

- Wobbling secondary mirror with f/35 in Cassegrain focus, new telescope top-ring which puts radiating material away from light beam.

For more details see *Messenger* No. 13.

Cassegrain Echelle Spectrograph (CASPEC) (M. le Luyer, J. Melnick). Target date: end 1980.

- Instrument with resolution of 15,000, 30,000 and 60,000 with an SEC-Vidicon detector. Data-reduction process not yet defined in detail.

More details will be published in the next *Messenger*.

Compared to the schedule which was published three months ago three dates have changed: The target date for the Triplet Adaptor is delayed one month due to operational reasons (observation schedule). The target date for the Coudé Echelle Scanner is

delayed half a year due to difficulties during design and manufacture, and the target date for the Infrared Top-End is delayed half a year to give priority to the development of the Infrared Photometer for the Cassegrain focus of the 3.6 m telescope. W. Richter

INFORMATION FOR VISITING ASTRONOMERS

Spectrograph Gratings on La Silla

The gratings listed in the table below are now available on La Silla for the Boller and Chivens spectrographs on either the 3.6 m or 1.5 m telescopes.

Grooves per mm	Grating Blaze Angle		1st Order Central Disp. λ Å/mm		2nd Order Central Disp. λ Å/mm	
225	5°	12'	7280	298	3640	149
300	4°	18'	4550	220		
300	8°	38'	9100	228	4550	114
400	4°	30'	3640	171		
400	9°	42' 42	7703	172	3852	86
400	13°	54'	10920	175	5460	88 ¹
600	8°	38'	4550	114		
600	13°	00	6825	116	3412	58
600	13°	00	6825	116	3412	58
600	17°	27'	9100	118	4550	59 ²
900	21°	06'	7280	78	3640	39
1200	26°	45'	6825	60	3412	30
1200	36°	52'	9100	58	4550	29

¹ Not yet mounted in grating cell.

² At present still used in ESO TP Geneva for Reticon tests.

Since all gratings can be used with any of the spectrographs, it can happen that one grating is requested by various visiting astronomers simultaneously. In this situation the 3.6 m observer has priority.

G. Schnur, M. J. de Jonge

The Triplet Adaptor Soon Ready for 3.6 m Prime Focus Observations

M. Ziebell

The primary mirror of the 3.6 m telescope has a complicated figure, and a "corrector" must be inserted, just below the prime-focus cage, in order to obtain sharp images in this focus. Until now, a one-element (Gascoigne) corrector has provided a usable field of about 16 arcmin or 6 cm. However, the full advantage of the excellent optical quality of the primary mirror can only be realized with more complicated optical means. After a long period of testing, a three-element (triplet) corrector that is optimized for the blue spectral region and a similar one for the red region will now be installed. They are supported by the "triplet adaptor", an advanced optical-electronical-mechanical system that will be remotely controlled from the main observing console in the telescope control room. ESO engineer Manfred Ziebell is now trimming the rather complicated instrument to perfection and we may expect soon to see the first wide-field (1:2) photographs from the 3.6 m prime focus.

Since the winter time in Chile is the worst season for astronomical observations, it is a good time to install new instruments. It is therefore foreseen to install the *triplet adaptor* on the 3.6 m telescope in June 1979.

Presently, the simplified adaptor equipped with a Gascoigne corrector can be used for observations in prime focus on the 3.6 m telescope. This adaptor was developed for local control, and only the shutter and the High-Voltage of the TV camera are remote controlled.

The triplet adaptor, which is at the moment being assembled and tested in Geneva (see fig. 1), will be completely remote controlled and the number of facilities considerably increased.

The Triplet Adaptor

The main parts included in the triplet adaptor project are:

1. The triplet corrector.
2. The triplet adaptor (the mechanical support for instruments).
3. The handling structure.
4. The filter changer.
5. The plate changer.

The *triplet corrector* produces a corrected field in prime focus of 240 mm diameter, corresponding to a field of 1:2 in the sky. It is possible to change between a red and blue coated triplet. The exchange from one to the other must be done when the adaptor with its handling structure is on the prime unit carriage.

The *triplet adaptor* is supported by the prime focus pedestal and is fixed to it by a circular flange. At the top side, there is a square flange for the fixation of instruments. The back focal distance measured from this flange is 75 mm. The adaptor is connected to the support structure by two astatic levers, which diminish the forces on the focusing mechanism of the prime-focus pedestal. Due to this mechanism the adaptor can support instruments with a weight of up to 100 kg. The housing of the adaptor is a welded mild steel construction, stabilized after welding. It is reinforced by several ribs to get a light-weight, but rigid structure.

The adaptor offers several facilities for the observations. They are:

- (a) offset guiding via a low-light level TV camera,
- (b) an acquisition field of 46 x 38 arcmin with centerfield viewing,
- (c) focusing with a knife edge, and
- (d) the adaptor is prepared for automatic guiding and some kind of automatic focusing, but the installation has been postponed until the availability of an advanced autoguider.

To perform these functions several electro-mechanical devices are installed. Inside the adaptor housing are mounted:

1. The guide probe, which is mounted on the XY-table, including a focus mechanism to focus the star image on the crosshair, and a crosshair-knife edge support.
2. The x-y table, which moves the guide probe over a field of 150 x 125 mm (corresponding to 46' x 38') with a precision of 5 μ m.

Outside are mounted:

1. The low light level TV camera.
2. The focus mechanism for the TV camera.
3. The filter turret for the TV camera.
4. The field lens support, which projects the image of the main mirror on the TV camera for focusing.

The guide probe is mounted on an x-y table and picks up the light either from a guide star or from the centerfield (see fig. 2). The light is then transmitted via a focus mechanism onto the crosshair or the knife edge (1). Through a collimation lens (2) the light is reflected in a parallel beam down from the x-y table on a fixed mirror which reflects the light out of the adaptor housing. The star and the crosshair are then focused on the photocathode of the TV tube (7). In addition, a filter turret with 6 filters (4) and a movable field lens (5) are mounted in the beam.

The TV camera is a small Quantex camera type qx26 with an ISIT tube. The entrance window has a diameter of 16 mm. Due to the usable target dimensions the field of the Quantex camera is 9x12 mm, i.e. 53" x 70" on the sky, which corresponds to a rather high resolution (12 lines per arcsec). The limiting sensitivity of the camera will be in the order of $m = 18$ under good seeing conditions ($\leq 2''$).

For automatic guiding and focusing it was originally foreseen to use a quadrant photosil detector. Due to fabrication problems with the tube this feature has been dropped until another autoguider becomes available. However, an elec-

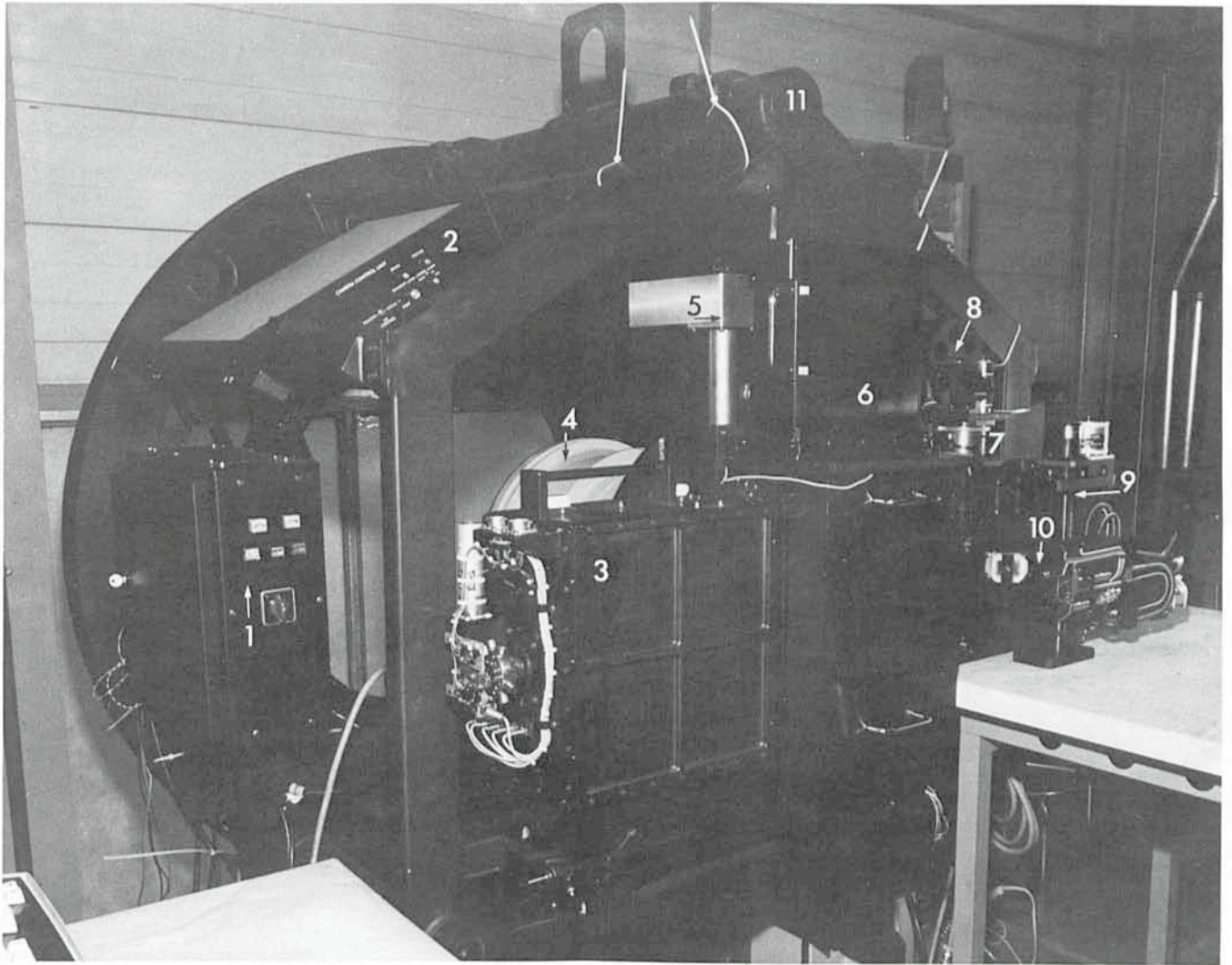

Fig. 1: The triplet adaptor during the tests in Geneva, before being shipped to La Silla. The various parts are indicated: (1) pedestal focus drive box, (2) camera control unit, (3) filter changer, (4) triplet corrector, (5) sensitometer, (6) plate changer, (7) TV focus drive, (8) TV filter turret, (9) X-Y carriage, (10) guide probe, and (11) handling structure.

tronic crosshair has been developed for the ESO Schmidt telescope, and it seems possible to use the video signal of the TV camera for automatic guiding after a rather small amount of additional development work. The advantages of such an autoguider would be:

- (a) The image of the video monitor is still visible in the automatic guiding mode,
- (b) the ISIT tube is one of the most sensitive detectors when no integration on the target and no cooling is used,
- (c) the electronics can be installed close to the monitor and the control computer (i.e. not at the telescope).

To be able to calibrate the nonlinearities of the photographic plates, a *sensitometer* is being installed on the adaptor. It is a slightly modified version of the Kitt Peak sensitometer. The image of a uniformly illuminated step wedge is projected onto the photographic plate, in a corner of the plate outside the sky field.

The control electronics for the triplet adaptor are installed in four steel boxes which are fixed to the support structure. To reduce power dissipation, low power logic components are used for the control electronics and dc motors for the drive systems. Where possible, electro-mechanical devices

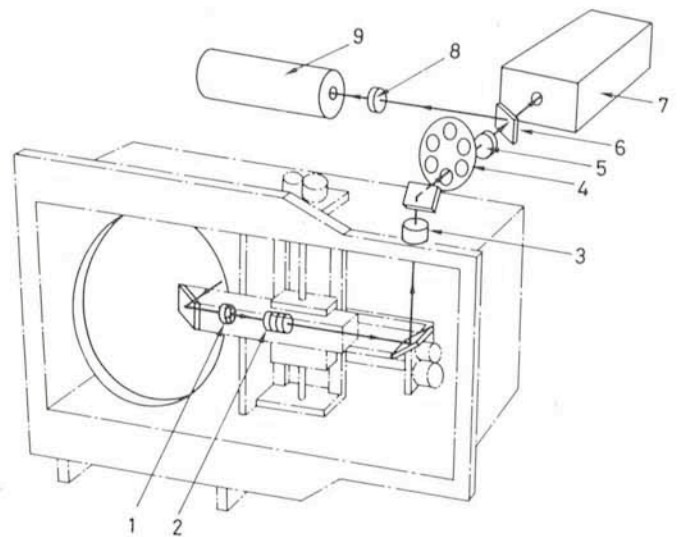

Fig. 2: Schematic diagram of the triplet adaptor: (1) crosshair and knife-edge support, (2) collimation lens, (3) focus lens for the TV, (4) filter turret, (5) pupil imaging lens for focusing, (6) beam splitter, (7) TV camera, (8) objective for automatic focus, and (9) autoguider (to be installed later).

are eliminated to increase the reliability. Inductive sensors are used as code and limit switches and relays are replaced by transistor switches.

The *handling structure* has several functions. It supports the triplet adaptor together with the instrument and the triplet corrector during the handling procedure. It diminishes the forces of the focusing mechanism of the prime focus pedestal by a pair of astatic levers. Furthermore it is provided with attachment facilities for a hook-on-chair. As it is foreseen to use this chair only for adjustment work, it will not be very comfortable and few functions of the adaptor have local control (this is another way of saying that we do not like to have the astronomer in the prime focus cage during the observations!).

One of the first instruments which will be fixed to the triplet adaptor are the filter and the plate changers. The first will be mounted onto the rectangular flange of the triplet adaptor and will carry the plate changer.

The *filter changer* (see also *Messenger* No. 10, p. 19) permits to change between 4 different colour filters of a size of 240 x 240 mm in front of the plate or film changer. The image of the sensitometer step wedge is also transmitted through these filters. The filter changer is equipped with a remotely-controlled shutter.

The *automatic plate changer* contains up to 8 photographic plates or film sheets of the dimensions 240 x 240 mm. The time to change a plate is 35 seconds. The complete unit is fixed to the filter changer by a four-point spring-loaded latch and can be disconnected quickly. It consists mainly of a plate displacement mechanism, a vacuum back-up plate, a housing with reference frame, a cas-

sette with 8 plates and a suction pump. A digital display is used to mark the plate number directly onto the plate. The hypersensitized plates in the cassette will be stored in a Nitrogen atmosphere, to reduce loss of sensitivity.

The complete operation sequence for the filter changer and the plate changer will be controlled by a Motorola microprocessor board. The hardware will be incorporated inside the instruments themselves to reduce the number of cable connections. To each instrument one cable connection to the RIOS (Remote Input-Output Station) is needed to enable remote control from the telescope control consol.

The triplet adaptor with its handling structure, the filter changer, the plate changer, the red and blue triplet correctors, the Gascoigne adaptor, the McMullan camera and further instruments must be stored on the platform extension (see fig. 3). For the exchange procedure, the platform movement and the canti-lever crane are used. Therefore the rotation movement of the canti-lever crane will be motorized and a manual control for the dome rotation will be installed on the platform.

The exchange between different top units for prime focus observations (e.g. from Gascoigne to triplet adaptor) will take 40 minutes. With an additional change from blue to red triplet corrector it takes 10 minutes more.

To change from one instrument to another, the triplet adaptor with its handling structure can stay on the telescope.

To exchange the red and blue triplets, the whole adaptor with its handling structure must be removed from the telescope, and the exchange must be done on the prime focus carriage. About 30 minutes will be needed for this proce-

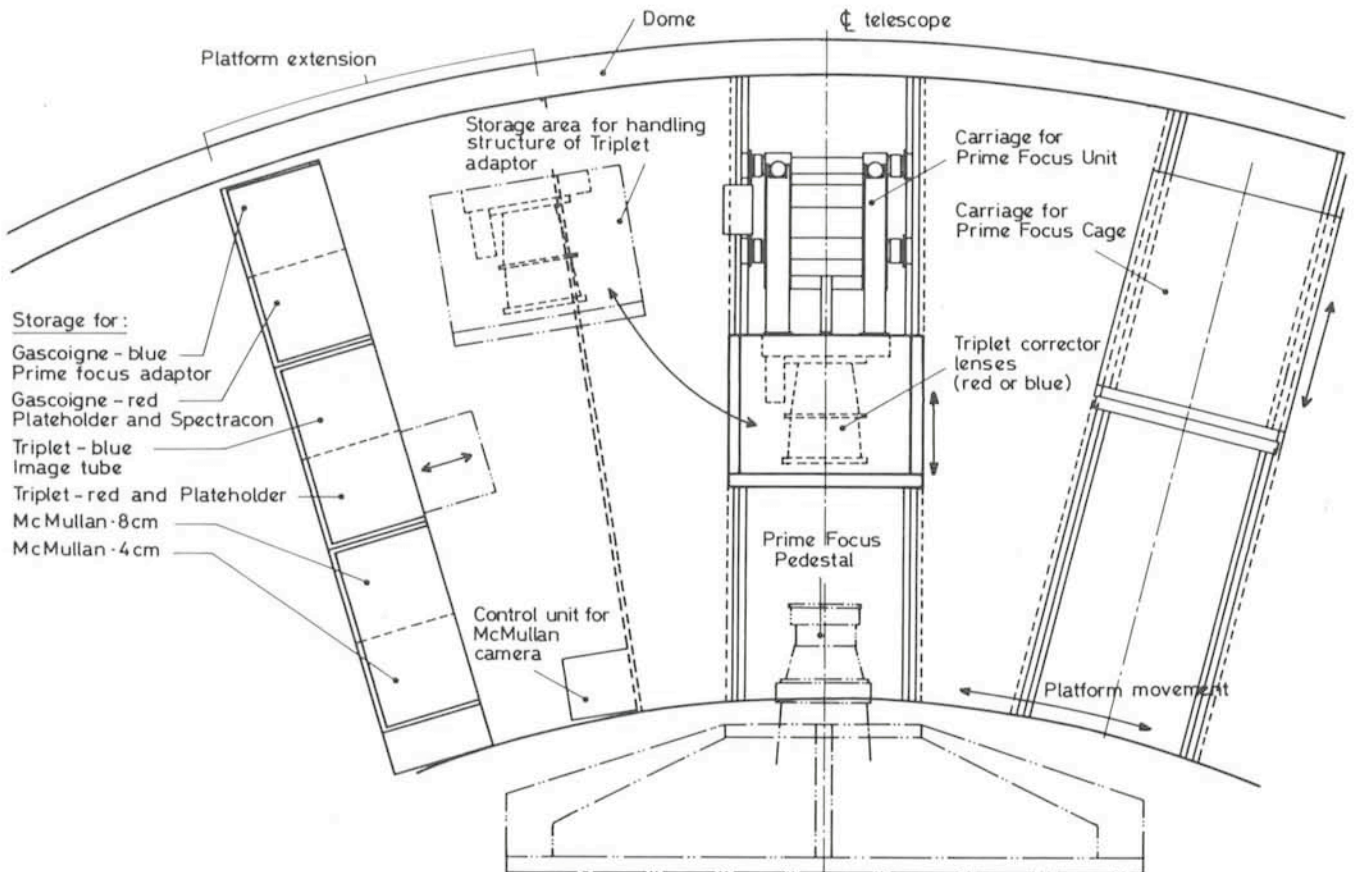
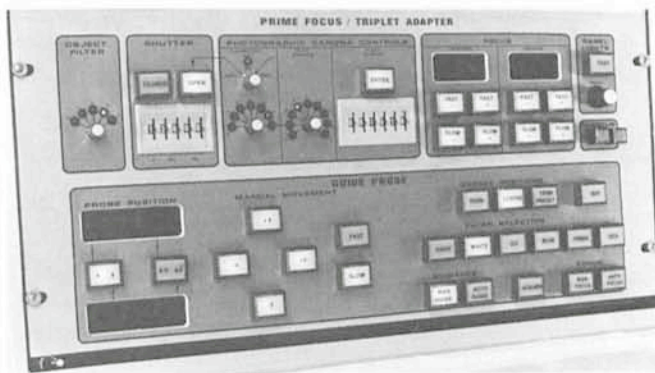

Fig. 3: Layout of the platform, seen from above. The front-end of the telescope is at the bottom.

ture. The same is valid when aperture plates for the McMullan cameras have to be installed.

A lot of discussion has taken place about the optimal use of the triplet adaptor and there will be more details to discuss in the future as it is difficult to find a solution that suits everybody. For the triplet adaptor it was decided to install a so-called "software switch panel" which will simplify the use and give a better overall view of the status of the triplet adaptor (see fig. 4). This panel still has to be interfaced to the 3.6 m control computer.

Fig. 4: "Software switch" panel for the 3.6 m triplet adaptor. ▶



Fauna on La Silla

I. Meinen

During most of the time ESO has existed, rumours about the "dangerous" animals on La Silla have circulated among astronomers in the member countries. It appears for instance that the "vinchucas" are often described in very exaggerated terms. We have asked Dr. Inge Meinen, ESO Administrator in Chile, to tell the readers (and in particular prospective visiting astronomers) the truth about the fauna on La Silla.

La Silla, the ESO Observatory site, is located at an altitude of 2,400 m in the "Norte Chico", the "little North" of Chile, in an almost—but not quite—desert country. In this dry and sunny climate, so well suited for astronomical observations, it enjoys but little vegetation and has a limited fauna as well.

Wild larger animals are non-existent, although the llama-like "guanaco" may sometimes come down from the high Cordillera (the Andean chain) in search of food. Occasionally some half-wild donkeys ("burros"), or mules, goats and dogs can be seen; they "belong" to seminomads who from time to time pass through ESO territory in search of pastures for their herds of goats, or are on their way to charcoal burning places, or trading goat cheese.

Recently more birds (sparrow-type species) settled on La Silla and some mountain foxes have almost become domesticated pets, as they find, or get food from La Silla dwellers (see *Messenger* No. 9, p. 20). The birds of prey of the region (vultures ("jotas") and condors) may sometimes be seen high in the air, but their aeries are far away from La Silla in the high Cordillera. There are numerous small, very timid, but extremely curious lizards taking the sun or in hiding behind the many stones on La Silla.

Few of the staff have ever seen a scorpion or a snake on La Silla. There is, however, the odd chance to encounter such animals, and walking barefoot is not recommended, not even indoors. In summer time (from December onwards) one should have a look into one's shoes before putting them on, and into one's bed after lifting the cover blanket. A scorpion bite, even though hurtful, is not life-endangering;

moreover, the risk to be bitten on La Silla is but a fraction of that encountered in a Hotel in provincial Italy or Spain.

Spiders are not uncommon on La Silla and some may look rather impressive (tarantulas), but they are not very poisonous.

Even in summer very few mosquitos appear, but sometimes an army of tiny inoffensive ants may invade a room (especially if there are leftovers of something sweet). They are easily destroyed with spray available in all the dormitories.

A few specimens of various types of beetles may be seen crawling on roads and pathways, and even indoors. Most of them are entirely harmless, and non of them will attack man in the open. Only one beetle type is a blood-sucker, like a mosquito, and its bite must be avoided: the *Triatoma Infestans*, popularly called "vinchuca". Vinchucas are rare in Chile nowadays and officially they count as extinct, but they do survive in remote rural areas. At some stage of its development this beetle can even fly. On La Silla, even though regularly sprayed and disinfected, some "invaders" have therefore been located every year.

The disinfection is made in all the dormitories and around them, in all the telescopes and around them, in the hotel, clubhouse, office and library building, other offices, technical installations, contractors' camps, Old Camp and Old



Fig. 1: A well-sized tarantula, photographed on La Silla in 1977 by ESO photographer B. Dumoulin.

Pelícano, including the houses of the Quebrada inhabitants (with their permission). During the summer time, the disinfections are repeated monthly and in the winter time, about every 2 to 3 months.

The vinchuca bite itself is not hurtful but there is a risk of later infection as the beetle may be host animal, carrier and transmitter of a parasite (*Tripanosoma cruci*) which also may affect man. The infection in man is called "Chagas disease" and is still widespread, for instance in certain tropical and underdeveloped parts of Brazil.

Only a small fraction of any vinchuca population is ever infected with *Tripanosoma cruci*. None of the vinchucas so far found on La Silla, and sent to the Institute for Tropical Diseases in Hamburg (FRG) for investigation, was infected. Such a check can also be made on a person who has been bitten, and anyone bitten by a vinchuca (or who suspects that he may have been), should undergo the necessary tests so that he may receive medication if necessary and thus avoid a severe infection.

The infection with Chagas disease typically presents itself with an initial feverish stage and may much later reappear as a heart condition or in the form of other internal troubles.

It may be of interest that the infection from vinchuca to man is not directly transferred by the bite of the beetle but by its droppings (a common reaction after the bite) which may get into the tiny wound inflicted by the bite.

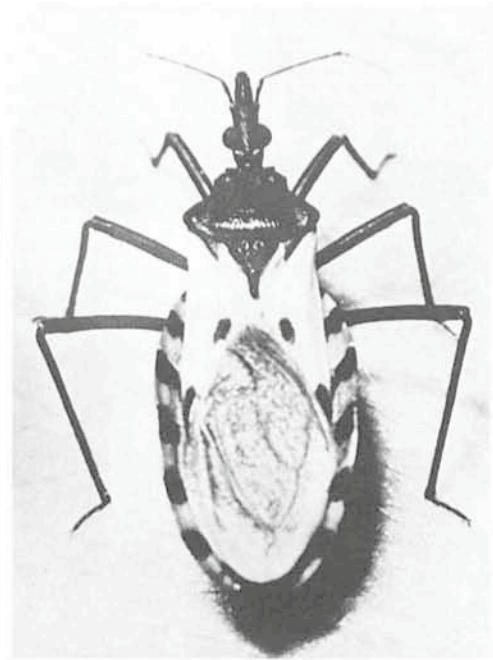

Fig. 2: One of the vinchucas that were sent to Europe for a test. Photographed by Dr. G. Schaub of the Zoological Institute of the Freiburg University (FRG).

Visiting Astronomers

April 1—October 1, 1979

Observing time has now been allocated for period 23 (April 1 to October 1, 1979). As usual, the demand for telescope time was much greater than the time actually available.

The following list gives the names of the visiting astronomers, by telescope and in chronological order. The complete list, with dates, equipment and programme titles, is available from ESO/Munich.

3.6 m Telescope

- April: Stenholm, Kohoutek, Schnur/Sherwood, Gillespie, Vogt, Pakull, Melnick/Quintana, Gammelgaard/Laustsen/Pedersen, Möllenhoff, Balkowski/Guérin, Chevalier/Ilovaisky/Motch.
- May: Chevalier/Ilovaisky/Motch, Epchtein/Turon/Puget/Wamsteker, de Loore, Audouze/Thuan/Dennefeld/Kunth, Kunth, Zuiderwijk, Bergeron/Boksenberg, Boksenberg/Caloi/Cannon/Castellani/Danziger, Boksenberg/Danziger/Fosbury/Goss, Boksenberg/Danziger/Fosbury/Goss/Bergeron.
- June: Boksenberg/Tarengi, Ulrich/Boksenberg, Terzan, van den Heuvel/van Paradijs, Wamsteker/Pedersen, Shaver/Danks/Pottasch, Alloin/Tenorio-Tagle.
- July: Alloin/Tenorio-Tagle, de Vries, Wamsteker/Pedersen, Lyngå, Vogt, Adam, Lub, Phillips, Rahe/Schnur/Bouchet.
- August: Rahe/Schnur/Bouchet, Bergvall/Ekman/Lauberts, Bergeron/Kunth, Hayli, Seggewiss, West/Kurtanidze, Alcaíno.
- Sept.: Sherwood/Kreysa, de Vegt, Wehinger, P. Véron, Norgaard-Nielsen/Kjaergaard Rasmussen, Goss/Shaver, Wamsteker/Danks.

1.52 m Spectrographic Telescope

- April: Grosbøl, Lindblad/Lodén, Bouchet, Ahlin/Sundman, M. Spite, Ilovaisky/Chevalier/Motch, Houziaux, Möllenhoff.
- May: Möllenhoff, de Loore, Zuiderwijk, Henrichs/van den Heuvel/van Paradijs, van Dessel, Rahe, Ahlin/Sundman, Metz/Pöllitsch, Appenzeller/Krautter/Mundt.
- June: Appenzeller/Krautter/Mundt, Imbert, Sterken, Renson, Manfroid/Heck, Bouchet, Ahlin/Sundman, Querci/Bouchet.
- July: Querci/Bouchet, de Vries, Arpigny, Bastiaansen, Rosa, King.
- August: King, Bouchet, Ahlin/Sundman, Häfner, Bergvall/Ekman/Lauberts, Schnur/Sherwood, Loibl/Schulz.
- Sept.: Loibl/Schulz, Bouchet, Ahlin/Sundman, Macchetto, Büscher/Bruch, Crane/Materne/Tarengi/Chincarini.

1 m Photometric Telescope

- April: Kohoutek, Hunger/Groote/Schultz, Schmidt/Engels/Schultz, Wamsteker, Wamsteker/Weiss, Bensammar, Lundin, Pakull, Pedersen, Vogt.
- May: Pedersen, Vogt, Shaver/Danks/Wamsteker, Moorwood/Salinari, Bouchet, Wielebinski/Schnur/Mattila, Metz/Pöllitsch, Neckel.
- June: Neckel, Tarengi/Tanzi, Vogt, Mattila/Schnur/Pedersen, Schnur/Mattila, Querci/Bouchet.
- July: Querci/Bouchet, Epchtein/Turon/Roucher/Guibert/Nguyen-Q-Rieu/Wamsteker/Bouchet, Guibert/Nguyen-Q-Rieu/Turon/Epchtein/Roucher/Wamsteker/Bouchet, Lub, Adam, Bernard, Tinbergen.
- August: Tinbergen, Wamsteker, Wamsteker/Weiss, Alcaíno, Bergvall/Ekman/Lauberts, Schober.
- Sept.: Schober, Reipurth/Wamsteker, Büscher/Bruch, van Woerden/Danks, M.-P. Véron.

50 cm Photometric Telescope

April: Vogt, Kohoutek, Bouchet, Lundin, Houziaux, Debehogne.
May: Debehogne, van Paradijs, Wielebinski/Schnur/Mattila, Gahm.
June: Gahm, Metz/Pöllitsch, Mauder, Mattila/Schnur/Pedersen, Schnur/Mattila, Terzan.
July: Terzan, Lundvall, Bastiaansen, Bouchet.
August: Bouchet, Häfner, Schober, Loibl/Schulz.
Sept.: Loibl/Schulz, Macchetto, Drechsel/Groote, Bouchet.

40 cm GPO Astrograph

April: Bensammar, Debehogne, Giesecking.
May: Giesecking.
June: Giesecking.
July: Giesecking.
August: Giesecking.
Sept.: Giesecking.

50 cm Danish Telescope

June: Renson, Sterken/Vanbeveren.
July: Sterken/Vanbeveren, Ardeberg/Gustafsson.

61 cm Bochum Telescope

August: Lagerkvist.
Sept.: Leandersson.

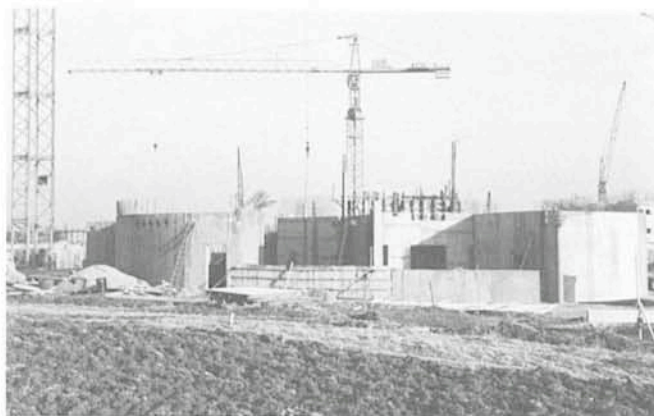

This photograph of the construction site of the ESO Headquarters building at Garching, taken on March 1, 1979, shows the progress made since mid-November last year (see Messenger No. 15, p. 25).

ESO Headquarters Agreement Signed

On January 31, 1979, the Director-General of ESO, Prof. L. Woltjer, and Staatssekretär Dr. P. Hermes signed the ESO Headquarters Agreement at the German Foreign Office in Bonn.

Among other things this Agreement stipulates that the Government of the Federal Republic of Germany provides

ESO with a site and the buildings for their European Headquarters. The site, which is situated at Garching, shall be granted to ESO by the Max-Planck-Gesellschaft for a period of 99 years by means of a building lease.

The building is already under construction and shall be ready in summer 1980.



Signature of the ESO Headquarters Agreement by the Director-General of ESO, Prof. L. Woltjer, and Staatssekretär Dr. P. Hermes. From left to right (clockwise): Dr. Sandtner, Prof. Priester, Prof. Denisse, Prof. Woltjer, Dr. Rau, Mr. Loosch, Dr. Zelle and Dr. Hermes.



Further to the La Silla Fauna...!

The telescopes on La Silla were again heavily oversubscribed (see page 30) and some members of the Observing Programmes Committee have hinted that drastic measures may soon have to be taken in order to reduce the number of applications for telescope time. We do not know exactly what they have in mind, but here is our contribution: a proposal for the cover of the new version of the application forms. (Drawn by Karen Saxby.)

The Bright Pre-Main-Sequence Shell Star HR 5999

P.S. Thé and H.R.E. Tjin A Djie

It has been known for some time that stars are born by contraction in interstellar clouds. During most of this phase they remain invisible to us, because of the gas and dust shell in which they are imbedded. It is only towards the end of the birth process, when they approach the Zero-Age Main Sequence in the Hertzsprung-Russell diagram, that the newborn stars start to shine through their cocoon. At least that is what most astronomers thought until recently, when observations showed that the very young star HR 5999 is at least three magnitudes above the Main Sequence. Drs. Pik Sin Thé and H.R.E. Tjin A Djie from the Astronomical Institute of the University of Amsterdam (the Netherlands) explain how HR 5999 was recently observed simultaneously from La Silla, South Africa and with the IUE satellite.

The Herbig Ae-Be-type stars are generally thought to represent an early phase of stellar evolution, which precedes the main sequence A- and B-type stars. They bridge the gap between the birth of stars of 3-5 M_{\odot} from a nebula consisting of gas and dust and the main-sequence stage. The general idea is that in the beginning this nebula obscures the newly-born star. During the pre-main-sequence phase the nebula has almost disappeared and this situation offers unique possibilities to observe the star and its circumstellar matter in all spectral regions from the far ultraviolet up to the infrared.

The Pre-Main-Sequence Star HR 5999

HR 5999 (= HD 144668) is one of the brightest Herbig Ae-Be-type stars. It provides us with an excellent opportunity to make a detailed study of the pre-main-sequence stage. Since the brightness is variable in an irregular way ($V = 7^m - 8^m$), an international cooperation was organized in 1978 to observe the star simultaneously by means of different observational techniques.



Fig. 1: The double-star system Δ 199 (HR 5999/6000) and its environment. Notice the dark clouds and the reflection nebulosity around Δ 199. The system is shown enlarged in the insert. Reproduced from the ESO (B) Atlas. North is up and East to the left.

HR 5999 does not appear in Herbig's 1960 list of probable pre-main-sequence stars with masses larger than those of T Tauri stars. The first detailed observations were made in 1970 by Bessell and Eggen at Mount Stromlo Observatory (Australia). According to them it has a proper motion in common with HR 6000 (= HD 144669) so that it is believed that these stars form a physical double star system (Δ 199), which is seen projected against a very dense dark butterfly-shaped cloud in the constellation Scorpius. A reflection nebulosity surrounding Δ 199 suggests that this binary is intimately associated with the cloud (fig. 1). In the immediate surroundings of Δ 199 more than 10 faint $H\alpha$ emission objects, most probably very young T Tauri stars, have been found by one of us (P.S.T., 1962) in a survey of emission $H\alpha$ objects in southern dark clouds, made with the Schmidt-type telescope of the Bosscha Observatory in Lembang (Indonesia). Subsequent photometric and spectroscopic observations by Bessell and Eggen show that HR 5999 is irregularly varying, that it exhibits circumstellar shell lines of H, Fe II, Ti II, Mg II, Na I and Ca II, and that the $H\alpha$ and $H\beta$ Balmer lines are in emission. From these facts one can already conclude that HR 5999 is very probably a Herbig-type pre-main-sequence object. It should be mentioned here that HR 6000 is, surprisingly, an Ap star located in the environment of a system of very young objects. So far no brightness variations of HR 6000 have been detected.

Photometric Observations

HR 5999 has recently been followed photometrically by Thé and his collaborators in April–May 1976 and in July–October 1977, in order to obtain a better knowledge of its light-curve in general, and in particular to study whether there are rapid smaller-scale variations or not. In 1976 the Walraven VBLUW photometer attached to the 90 cm light collector of the Leiden Southern Station Hartbeespoortdam (LSSH), South Africa, was used. In 1977 the same photometer and the Strömgren-type photometer were employed, the latter one attached to the Danish 50 cm telescope at ESO (La Silla). The combined light-curve of 1977 is shown in figure 2 (*Astronomy and Astrophysics, Suppl. Series, Vol. 33, page 17*). From this light-curve it is especially to be noted that at maximum the star varies rapidly.

From the photometric data the following results have also been derived. The 1976 Walraven photometry of the non-variable star HR 6000 can be used to determine that the foreground extinction $E(B-V)_J = 0^m.2$ (J stands for Johnson) and that the photometric distance of Δ 199 is 270 pc. By plotting the visual magnitude against colour index during the light-variation one can derive the ratio of total to selective absorption of the material in the circumstellar shell of HR 5999. Since the total extinction is known, it is then possible to derive the extinction-free brightness of the star, and with its distance also the absolute magnitude: $M_{V,J} = -0^m.9$. The spectral type estimated by Bessell and Eggen is A7 III-IV. The resulting position of the star in the HR diagram is about 3^m above the main sequence, in support of its pre-main-sequence character. A tentative comparison with Larson's evolutionary tracks shows that the star lies on a $3 M_{\odot}$ track and could have an age of 7×10^5 years. However, in the models of Larson the star should not be visible during this evolutionary stage, being still heavily covered by an opaque envelope. This is in contradiction with our observations. It is therefore important to make a more profound study of the physical properties of gas and dust in the shell, to obtain better input data for the theoretical calculations.

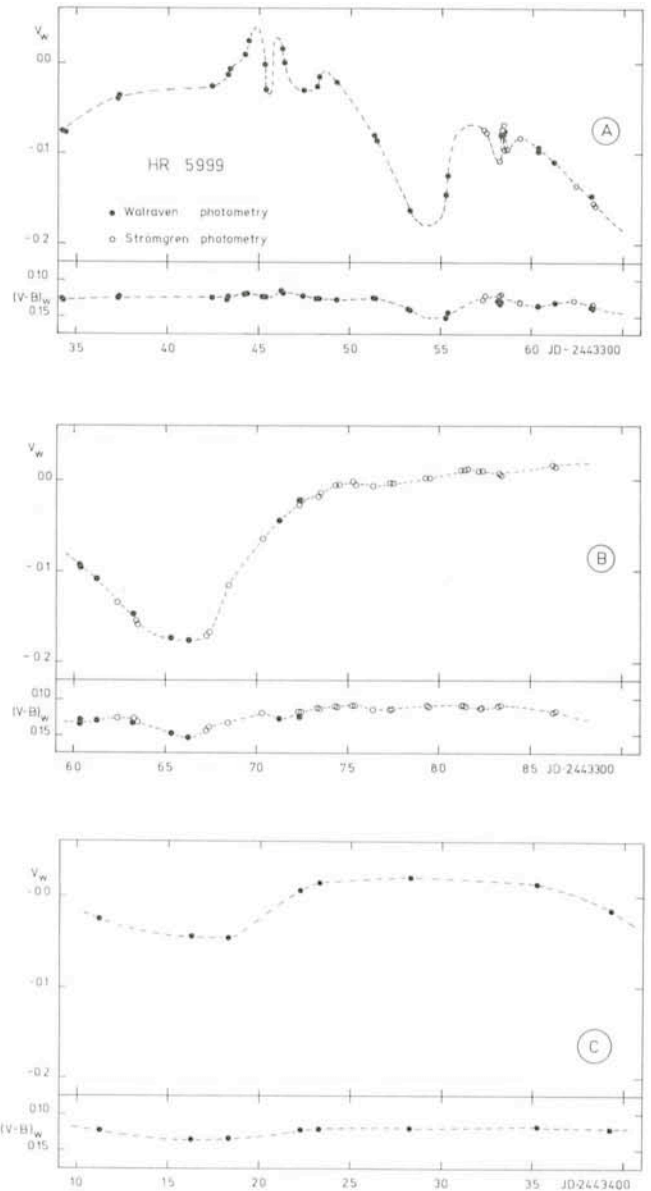

Fig. 2: The light and colour curves of the variable shell star HR 5999 measured from July 9 to October 22, 1977, at the Leiden Southern Station Hartbeespoortdam (Walraven photometry) and the European Southern Observatory, La Silla (Strömgren photometry). The Strömgren photometric results have been transformed to the Walraven system.

Further study of the photometric data reveals that the Balmer jump remains constant during the brightness variation of the star. It can thus be concluded that these variations are not caused by intrinsic changes in the photospheric temperature, but rather by variations in the column density of the circumstellar dust. Dust column density and grain size can be estimated from the extinction variation if the composition of the dust grains is known. If we assume that the grains consist of an iron core surrounded by a mantle of $MgSiO_3$, we find a grain radius of $0.16 \mu m$ and a column density variation between 1.8×10^9 and $6.1 \times 10^8 cm^{-2}$. The rate of change is about $1.4 \times 10^8 cm^{-2}$ per day. Additional information concerning the grain composition may be obtained from infrared and ultraviolet observations.

A very important result has been obtained by Smyth, Dean and Robertson in 1977 at the South African Astronomical Observatory (SAAO). Their observations show that the star

exhibits a large infrared excess radiation which could be attributed to either graphite or iron grains with a temperature of 1,100 °K or 900 °K, respectively.

International Cooperation

In 1978 several astronomers agreed to join efforts to study HR 5999 simultaneously with various techniques. In April simultaneous infrared and optical photometry of the star was carried out by Smyth (Edinburgh) in cooperation with Andrews of SAAO. A shallow minimum ($\Delta V = 0^m.25$) was observed. During this period a few coudé spectra were obtained by de Loore and Marijke van Dessel (Brussels) with the 1.5 m telescope at ESO (La Silla). A second period of simultaneous observations was carried out during the last 12 nights of May. The first 5 nights were devoted to infrared photometry between 1.25 and 4.8 μm by Thé and Wamsteker (ESO) with the 1 m photometric telescope. Hereafter Thé took coudé spectra of the blue and red spectral regions with the 1.5 m telescope. During the whole period of observations the star was followed photometrically at La Silla with the 50 cm Danish and the 60 cm Bochum telescopes by Bakker (Amsterdam) and Zeuge (Hamburg), respectively. These data show again a shallow minimum with $\Delta V = 0^m.2$.

Polarization was observed during April and May by Bastiaansen (Leiden) with a polarimeter attached to the light collector of the LSSH. Meanwhile at four nights in May the star was observed spectroscopically with the IUE satellite (cf. *Messenger* No. 15, p. 27) in the far ultraviolet by Viotti and Cassatella (Frascati, ESTEC), and by Gahm and Fredga (Stockholm). Besides these data at shallow minimum, a few spectra were taken at ESO at the times of deep photometric minima ($\Delta V = 1^m$), in April 1976 by Andersen (Copenhagen) and in July 1978 by de Loore and van Dessel (Brussels). Another deep minimum was measured by Thé during August 1978 with the Walraven photometer at LSSH. All these data are now being reduced and analysed.

The infrared, ultraviolet and polarization data are expected to give limitations as to the possible *composition* and *temperature* of the grains, and hopefully to impose some constraints on the parameters of the dust shell. The spectra in the visible and the ultraviolet contain information on the emission and absorption regions of the gas shell. The time variations of the gas and dust components of the shell seem somehow to be correlated and a detailed study of this phenomenon should throw some light on the question of the origin of the dust variations, and on the more general problem of the evolution of the circumstellar dust shell.

The ESA Astrometry Satellite

E. Høg

Recent advances in methods and instruments for astrometry (i.e. the accurate determination of positions in the sky of astronomical objects) have resulted in a proposal for an astrometrical satellite by a group of European astronomers. Dr. Erik Høg of the Brorfelde Observatory (Copenhagen University, Denmark) outlines the project and explains how it would make possible an incredible number of accurate, positional observations of the brighter stars.

A technological study has demonstrated the feasibility of an Astrometry Satellite which will be able to obtain an accuracy of $\pm 0'.002$ for parallaxes, yearly proper motions and positions of 100,000 stars, mostly brighter than $m_B = 11$.

It is emphasized that the scientific impact of these orders of magnitude improvements over present data will be multiplied if astrophysical data are also obtained for the selected stars by ground-based techniques.

Why Do Astrometry From Space?

Astrometric observations obtained from an instrument outside the earth's atmosphere should be more accurate than ground-based observations for a number of reasons. There is no refraction and no instrumental flexure due to gravity: The optical resolution of the telescope is not deteriorated

and variable due to atmospheric turbulence. In return for these advantages, a number of technological problems must, however, be solved in connection with the optical system, the thermal control and the attitude stabilization of an Astrometry Satellite (AS or HIPPARCOS).

The European Space Agency (ESA) has carried out a feasibility study of such a satellite in a collaboration between a team of scientists and a number of industrial firms from ESA countries. The study has demonstrated that an AS is feasible. It employs the optical principle of a two-axis telescope for scanning of great circles as proposed by P. Lacroute many years ago. It has now been imbedded in the framework of a professional spacecraft design, as required for the judgement of feasibility, and incorporates new ideas for optical system, scheme of scanning the sky, orbit, photoelectric detection, data analysis, etc. The AS will be launched into a geosynchronous orbit.

What will be Observed?

About 100,000 preselected stars, most of them brighter than $m_B = 11$, will be observed. The predicted accuracy of the observed parallaxes, proper motions per year, and positions is $\epsilon = 0'.002$ for stars of $m_B < 11$, degrading to $\epsilon = 0'.010$ at $m = 14$. This includes all sources of error: photon statistics, attitude instability, optical aberrations, thermal disturbances, etc.

The 100,000 stars will be selected in advance by astronomers according to the astrometric and astrophysical criteria they may wish. A rather uniform distribution of the stars on the sky is required for technical reasons. All 60,000

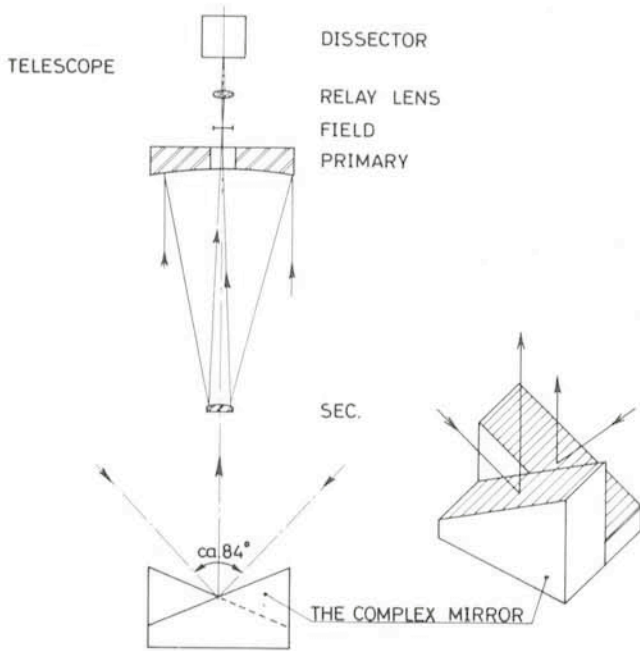

Fig. 1: Optical system of the AS. It sweeps the sky while it spins around an axis perpendicular to the two optical axes.

stars with $m_B < 9$ may be included. In response to an inquiry on scientific projects with the data, many proposals were received. Altogether 90 projects or investigations were defined by about 60 astronomers at 17 institutions. More proposals are of course very welcome and are being collected by the present author. A colloquium was held in Padova on 5–7 June 1978 with the participation of European and American astronomers to discuss the scientific impact of the AS.

Since the scientific importance of these new astrometric data will be greatly increased if other astrophysical data are obtained for the same stars at the same time, a joint meeting of IAU commissions is being planned for Montreal in 1979. Radial velocities, photometry and spectroscopy are desira-

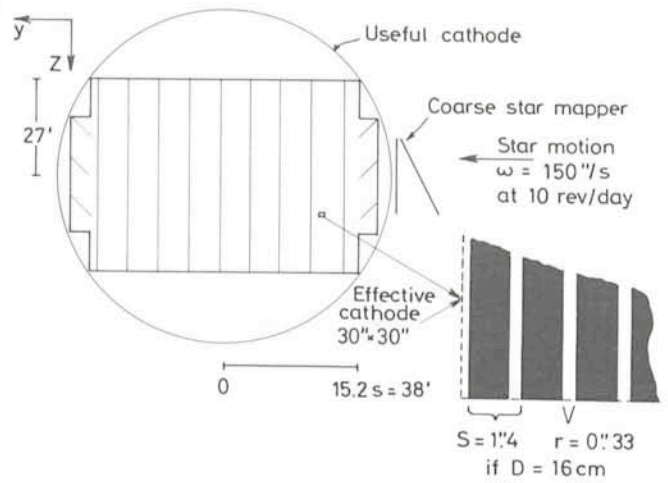

Fig. 2: The light from a star is modulated by the grid system. The cathode spot is switched back and forth between two stars for a few seconds while the intensity is recorded. Then the next pair of stars will have its turn.

ble for these fairly bright stars and the joint meeting may thus be called: "New basic astronomical data of bright stars".

The estimated time schedule for the AS, if it is finally approved by ESA, contains a launch in 1984 followed by 2.5 years of operation. A number of preparations before the launch are expected from the scientific community: definition of investigations, selection of stars, ground-based observations of radial velocities and photometric data, development of reduction procedures. ESA's responsibility will be the development and launching of the spacecraft as well as data acquisition, transmission to the ground and a first evaluation of the data. Final evaluation and application of the astrometric data will be the responsibility of the astronomical institutes.

It is hoped that the European Southern Observatory will play an active role in obtaining the ground-based astrophysical observations.

List of Preprints Published at ESO Scientific Group

December 1978–February 1979

38. J. BREYSACHER and M. AZZOPARDI: A Search for New Wolf-Rayet Stars in the Small Magellanic Cloud. Submitted to *Astronomy and Astrophysics*.
39. N. VOGT and M. FAUNDEZ: Photoelectric Observations of Peculiar A and Related Stars. I. Strömgren Photometry of 341 Ap Stars. Submitted to *Astronomy and Astrophysics*, Supplement Series.
40. H. STEPPE, P. VÉRON and M.P. VÉRON: The Surface Density of QSOs. Submitted to *Astronomy and Astrophysics*.
41. R.M. WEST and R.A. BARTAYA: A Preliminary Investigation of a Distant Globular Cluster in Eridanus (GCL 0422-213). Submitted to *Astronomy and Astrophysics*, Supplement Series.
42. R.C. KRAAN-KORTEWEG and G.A. TAMMANN: A Catalogue of Galaxies Within 10 MPC. Submitted to *Astronomische Nachrichten*.
43. M. AZZOPARDI and J. BREYSACHER: New Wolf-Rayet Stars in the Large Magellanic Cloud. Submitted to *Astronomy and Astrophysics*.
44. H. QUINTANA and R.J. HAVLEN: A Detailed Photometric and Structural Study of the Southern Cluster of Galaxies CA 0340-538. Submitted to *Astronomy and Astrophysics*.
45. P. VÉRON: Un Essai de Classification des Galaxies à Noyau Actif. Submitted to *Annals de Physique*.
46. E.G. TANZI, A. TREVES, P. SALINARI and M. TARENGHI: On the System V961 SCO \equiv OAO 1653-40. Submitted to *Astronomy and Astrophysics*.
47. D. ALLOIN, S. COLLIN-SOUFFRIN and M. JOLY: Line Intensity Data Compilation for a Sample of H II Regions. Submitted to *Astronomy and Astrophysics*, Supplement Series.
48. D. ALLOIN, S. COLLIN-SOUFFRIN, M. JOLY and L. VIGROUX: Nitrogen and Oxygen Abundances in Galaxies. Submitted to *Astronomy and Astrophysics*.
49. A. SANDAGE, G.A. TAMMANN and A. JAHIL: The Velocity Field of Bright Nearby Galaxies. Submitted to *Astrophysical Journal*.
50. A.C. DANKS, S. LAUSTSEN and H. VAN WOERDEN: Dust and Young Stars in the Lenticular Galaxy NGC 5102. Submitted to *Astronomy and Astrophysics*.

Test Assembly of the CAT

T. Andersen

A preliminary report on the Coudé Auxiliary Telescope for the 3.6 m telescope coudé spectrograph was given in Messenger No. 10 by Dr. Torben Andersen, ESO engineer in Geneva. Good progress has been made and the following summary, also by Dr. Andersen, indicates that the CAT will start observations on La Silla in a little more than one year from now.

The CAT telescope has been designed by ESO TP in Geneva, but the fabrication of the telescope is to a large extent carried out by European industry. The manufacturing stage is now nearing completion and the telescope is being test assembled in Geneva.

CAT Mechanics

The contract for the manufacture of the CAT mechanics was awarded to the German company MAN in January 1978. During the spring of 1978 detail drawings were elaborated by MAN. The large pieces were welded in the period July to September. In October the main mirror cell was finished and shipped to the optics contractor in England.

In November 1978 to January 1979 the large pieces were machined at MAN who has considerable experience in the machining of large telescope parts. This experience, combined with the availability of large and exact machine tools, made very precise machining possible. The bores of the

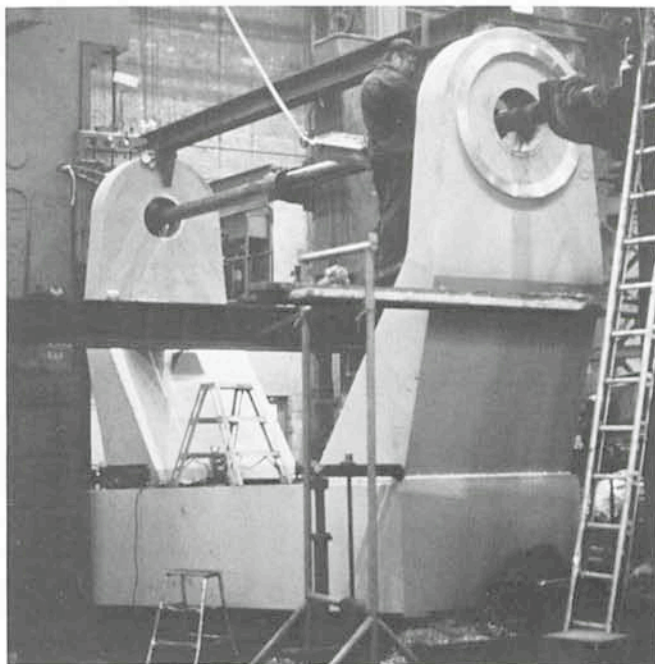

Fig. 1.

main axes of the telescope were machined together without altering the setting of the machine or the part being machined. Figure 1 shows the machining of the pedestal.

In January all pieces were finished at MAN and a partial assembly was made. The telescope was transported to Geneva by the end of January 1979.

The assembly began early in February, and in the middle of February (when this is being written) most of the telescope was assembled. Figure 2 shows the installation of the centre section. The assembly is expected to be finished according to schedule by the end of February.

Mirror Handling Equipment

Certain equipment is needed for the mirror handling and maintenance of the CAT telescope. This equipment was designed in the second half of 1978 and a contract for the manufacture awarded to the company F. G. Niensens Eftf. in Denmark. The fabrication is reported to be making good progress and delivery will take place by the end of March 1979.

Optics

The optics contract was awarded to Grubb Parsons in March 1978, and the main mirror is nearing completion. The grind-

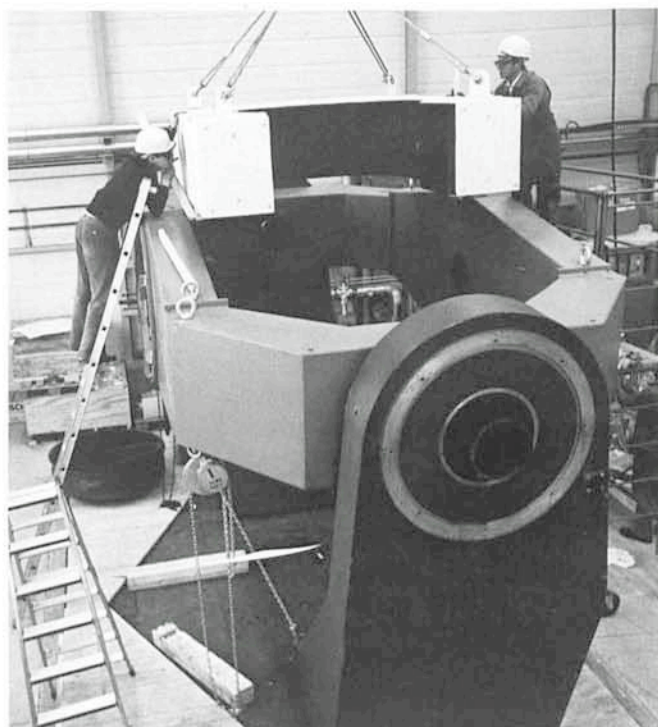

Fig. 2.

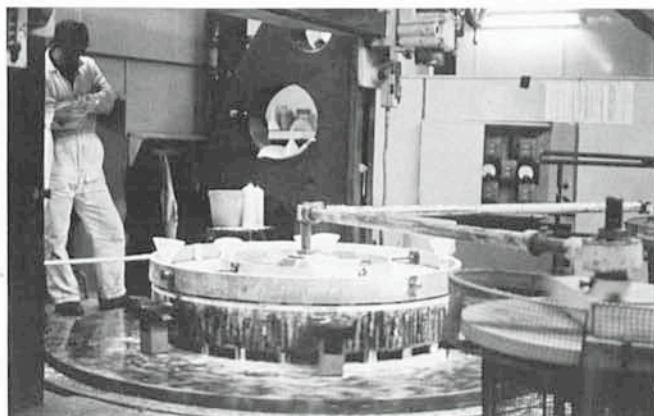

Fig. 3.

ing phase of aspherizing was finished in January and figuring is now proceeding (fig. 3). Acceptance tests will be carried out this spring.

Electronics and Software

The design work is complete. All major rack units have been manufactured and are currently being tested and installed. Only the telescope console requires further work but will be ready for the final installation in Chile. Preparation of the cables is now complete and the running of the telescope cables is expected to be finished by the end of March 1979.

The software is currently being written and all software

necessary to implement the servoloops and to move the telescope will be ready for the tests this spring.

Time Schedule

It is foreseen that tests in Geneva will end in June and the telescope will thereafter be shipped to La Silla. Erection and installation is planned for the end of the year with a considerable part of the auxiliary mechanics having been installed by ESO-Chile during the summer of 1979. Optical alignment and tests will take place early in 1980 and regular operation could start around April 1980.

Probable Optical Identification of LMC X-2

During the last year enormous progress has been achieved in the optical identification of X-ray sources. With the X-ray satellites SAS-3 and HEAO-1 positions with an accuracy of $10''$ have been determined, and even more precise results will be obtained with the recently launched Einstein-Observatory (HEAO-B).

Accordingly, astronomers have been pointing the "big" telescopes of the 3–5 m class towards the unidentified X-ray sources and in many cases only a few faint stars remain to be investigated as possible optical counterparts.

Accurate positions for the X-ray sources in the Large Magellanic Cloud (LMC) have recently been measured by Johnston *et al.* (1978, *Astrophys. J.*, L 59) with HEAO-1. So far, only LMC X-4 has been optically identified (cf. *Messenger* No. 9, p. 4). Two early-type stars, R 148 and a 17-mag B star, have been proposed earlier to be the optical counterparts for LMC X-1 and LMC X-3, respectively, from the less precise positions obtained from the UHURU and COPERNICUS satellites. The recent HEAO-1 results confirm their association with the corresponding X-ray sources.

Thus, we are left with LMC X-2, the second of the bright X-ray emitters in the LMC. Shortly after its discovery the B3 supergiant R 96 was proposed as the most likely counterpart. Since then various astronomers, including the author, have searched for ellipsoidal variability as seen in most massive X-ray binaries. However, HEAO-1 now tells us to forget about R 96 as the optical counterpart of LMC X-2. The new error box only includes a few inconspicuous stars fainter than about 18 mag. Fortunately, several ESO Schmidt plates in the U, B and V bands, covering the LMC X-2 field, were available in Geneva.

As can be readily seen from figures 1 and 2 the star marked E appears quite faint in the visual; on the ultraviolet plate, however, it looks rather conspicuous. Inspection of several U-plates taken a few weeks apart also suggest that star E is slightly variable.

In January the author was scheduled on the 3.6 m telescope equipped with the Image Dissector Scanner (IDS). In collaboration with ESO astronomers Drs. J. Lub, H. Pedersen, J. P. Swings and M. Tarenghi several spectra could be secured, which turned out to be not an easy task as the nearby star just to the east of star E had to be excluded. Integration times of two hours were necessary to obtain a reasonable signal-to-noise ratio. However, our efforts were rewarded as the spectra revealed the presence of $H\alpha$, He II λ 4686 and possibly C III-N III $\lambda\lambda$ 4640–4650 emission lines, the hallmarks of optical counterparts of X-ray binaries!

The Nature of LMC X-2

The faintness of star E ($V \approx 18.5$) rules out a massive X-ray binary system with an OB giant or supergiant optical primary as we observe for LMC X-4.

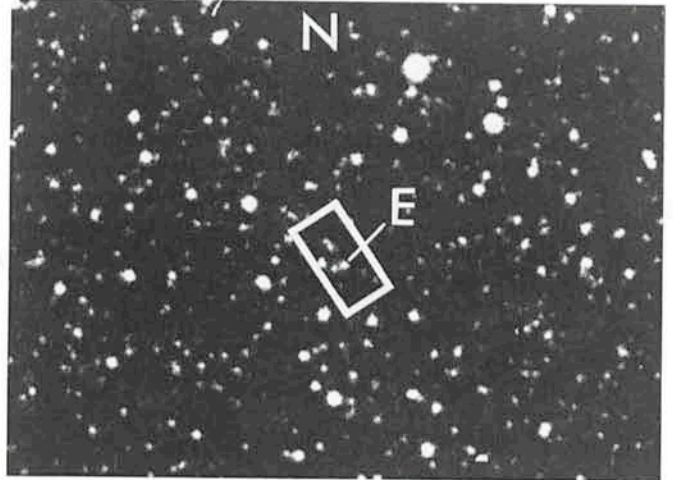

Fig. 1: The refined HEAO-1 error box ($24'' \times 36''$) for LMC X-2 superimposed on a print of a visual (V-band) ESO Schmidt plate. Star E is the proposed optical counterpart.

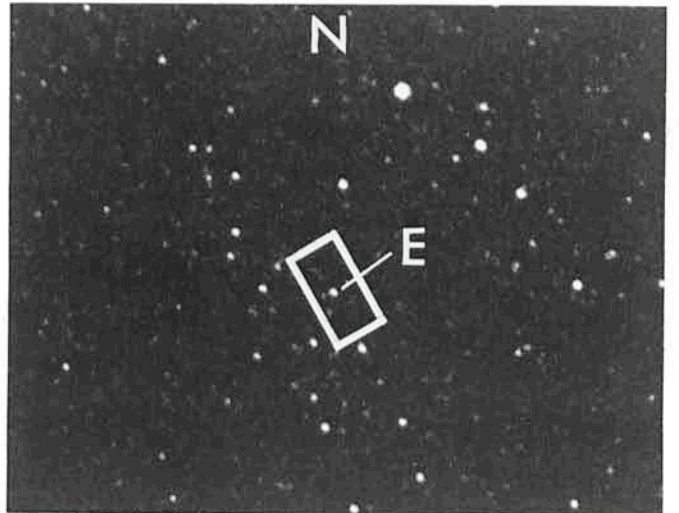

Fig. 2: Print of an ultraviolet (U-band) ESO Schmidt plate.

The deduced ratio of X-ray to optical luminosity L_x/L_{opt} of the order of 500 and an absolute visual magnitude M_V of about 0 corresponding to a distance modulus $m-M = 18.5$ for the LMC appears to be rather typical for a group of X-ray sources with low-mass companions. Sco X-1 is a well-known example, and most of the bright galactic bulge sources are thought to belong to this group. Their spectra

are dominated by a strong ultraviolet continuum and the presence of the same emission lines we find in star E. Their similar appearance can be readily understood taking into account that their optical emission is largely a product of the intense X-ray flux interacting with a normal stellar atmosphere or matter surrounding a close binary system.

M. Pakull

Messier 8 = NGC 6523—the Lagoon Nebula

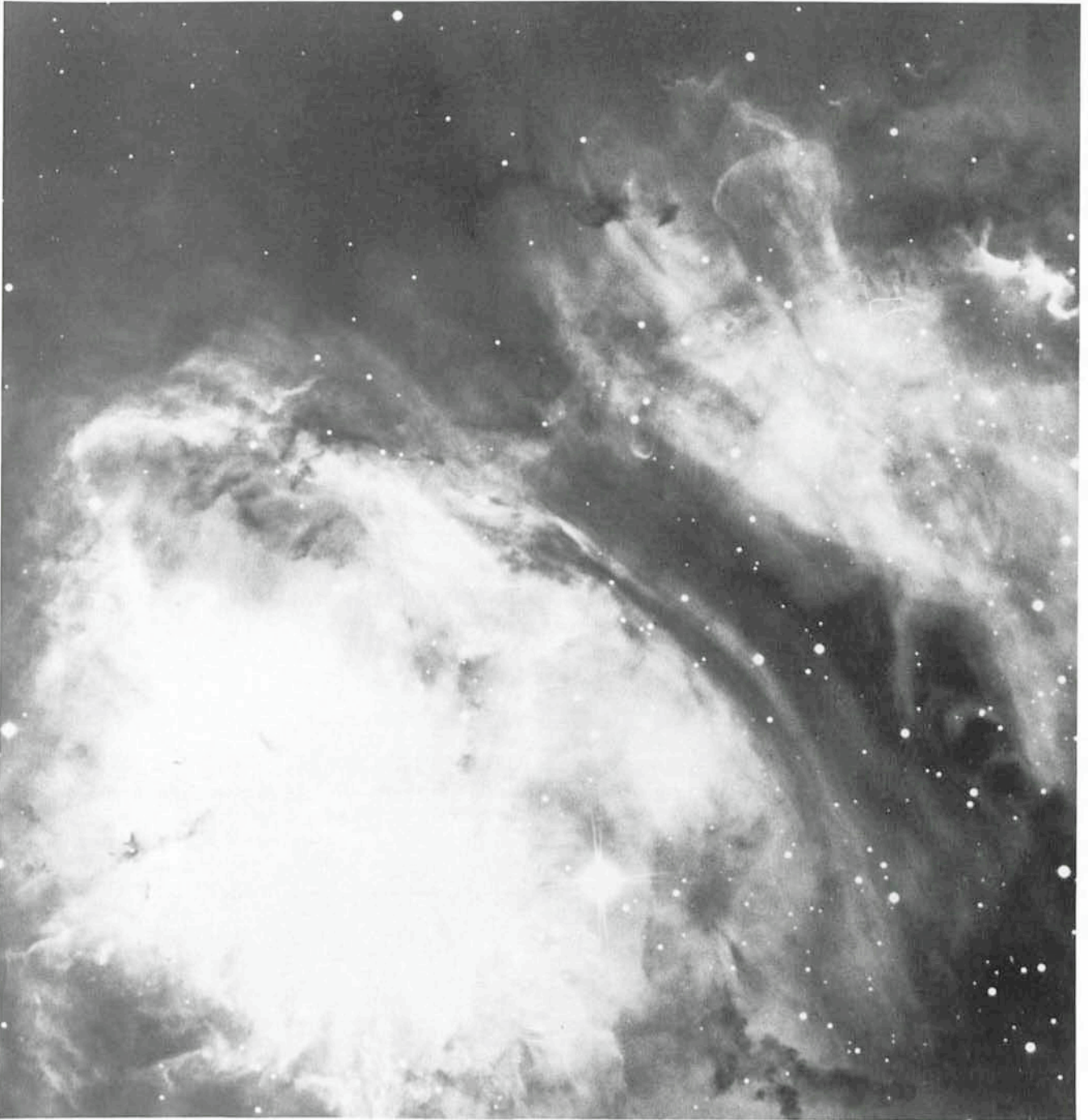

This photograph of one of the most beautiful nebulae in the Milky Way was obtained in the prime focus of the 3.6 m telescope by Dr. S. Laustsen. The exposure time was 30 min, emulsion IIIa-F through a RG 630 filter. It is one of the twenty 3.6 m photos in a forthcoming new set of slides from ESO. More details will follow in the next issue of the Messenger.

ESO, the European Southern Observatory, was created in 1962 to . . . establish and operate an astronomical observatory in the southern hemisphere, equipped with powerful instruments, with the aim of furthering and organizing collaboration in astronomy . . . It is supported by six countries: Belgium, Denmark, France, the Federal Republic of Germany, the Netherlands and Sweden. It now operates the La Silla observatory in the Atacama desert, 600 km north of Santiago de Chile, at 2,400 m altitude, where nine telescopes with apertures up to 3.6 m are presently in operation. The astronomical observations on La Silla are carried out by visiting astronomers—mainly from the member countries—and, to some extent, by ESO staff astronomers, often in collaboration with the former.

The ESO Headquarters in Europe will be located in Garching, near Munich, where in 1980 all European activities will be centralized. The Office of the Director-General (mainly the ESO Administration) is already in Garching, whereas the Scientific-Technical Group is still in Geneva, at CERN (European Organization for Nuclear Research), which since 1970 has been the host Organization of ESO's 3.6-m Telescope Project Division.

ESO has about 120 international staff members in Europe and Chile and about 150 local staff members in Santiago and on La Silla. In addition, there are a number of fellows and scientific associates.

The ESO MESSENGER is published in English four times a year: in March, June, September and December. It is distributed free to ESO employees and others interested in astronomy.

The text of any article may be reprinted if credit is given to ESO. Copies of most illustrations are available to editors without charge.

Editor: Richard M. West
Technical editor: Kurt Kjær

EUROPEAN
SOUTHERN OBSERVATORY
Schleißheimer Straße 17
D-8046 Garching b. München
Fed. Rep. of Germany
Tel. (089) 3204041-45
Telex 05215915 eso d

Printed by Universitätsdruckerei
Dr. C. Wolf & Sohn
Heidemannstraße 166
8000 München 45
Fed. Rep. of Germany

ALGUNOS RESUMENES

Folletos astronómicos

Los Drs. Philippe Véron y Gustav Tammann del Grupo Científico de ESO en Ginebra, ambos bien conocidos por su importante trabajo sobre objetos extragalácticos, han estudiado recientemente numerosos folletos a fin de verificar si ellos contienen alguna información astronómica de valor.

Después de la invención de la tipografía y de la máquina de imprenta en el siglo XV se publicaron un gran número de folletos para describir eventos extraordinarios como guerras, crímenes, milagros, catástrofes de cualquier índole, etc. Pero también fueron descritos fenómenos celestes, incluyendo auroras boreales, eclipses, conjunciones, bólidos, cometas, etc.

Tal como sucede con nuestros modernos periódicos, estos folletos usualmente se botaban una vez leídos y ésto es porqué la mayoría de ellos han desaparecido para siempre.

Hoy día se conocen más de 220 folletos astronómicos. El estudio de estos folletos revela que en la mayoría de los casos su valor científico es bastante limitado.

Son interesantes, sin embargo, para el historiador de la astronomía, porque dan a conocer la interpretación contemporánea sobre los eventos celestes.

Nombramiento de planetas menores

De acuerdo con una antigua tradición, el descubridor de un planeta menor tiene el derecho de darle un nombre. Hoy en día, un planeta menor es considerado "descubierto" y merece recibir un número y un nombre tan pronto haya sido observado en por lo menos tres oposiciones.

En 1975 comenzaron los descubrimientos de planetas menores con el telescopio Schmidt de ESO. Mientras tanto algunos de estos planetas han sido reobservados en ESO y otros observatorios; y recientemente, algunos fueron observados en la tercera oposición.

El primer planeta por ser nombrado, descubierto en ESO, fue encontrado en una placa obtenida en febrero de 1976 por Hans-Emil Schuster, a cargo del telescopio Schmidt de ESO. Su designación preliminar fue 1976 DA. Recibió el número (2105) y fue nombrado GUDY

por el descubridor. La *Minor Planet Circular* contiene la siguiente dedicación: "Nombrado por su descubridor para la Sra. Gudrun Werner de Hamburgo, como reminiscencia sentimental de la época de estudios. Este planeta menor del tipo Phocaea fue encontrado sobre la misma placa azul de investigación que el cometa Schuster 1975 II de perihelio largo."

El planeta menor 1978 AC fue descubierto por el astrónomo de ESO Richard West en enero de 1978. Fue observado durante varias ocasiones en 1978, y el Dr. Conrad Bardwell del Minor Planet Bureau en Cambridge, Mass., USA, pudo probar que era idéntico a 1936 VJ, 1951 YJ1 y 1975 VW8, basándose en cálculos orbitales preliminares. Estas observaciones se efectuaron en Niza, Francia (1936), Fort Davis, Texas, USA (1951), y en Crimea, Unión Soviética (1975), pero fueron muy pocas para establecer una órbita. Por esta razón las observaciones de ESO valen como descubrimiento, y porque 1978 AC fue ya observado en cuatro oposiciones, ha recibido ahora el número (2117). Aunque una muestra de dos casos pueda no tener significado estadístico, las razones sentimentales parecen prevalecer; este planeta se llama ahora DANMARK y la dedicación dice: "Nombrado en honor del país de origen del descubridor."

Un compacto grupo de galaxias: Klemola 25

El cúmulo Klemola 25, descubierto por A. Klemola en 1969, fue incluido en un reciente estudio general de cúmulos de galaxias cercanas. En página 24 una fotografía tomada por el Dr. Danks en el foco primario del telescopio de 3,6 m de ESO muestra este notable y compacto grupo de galaxias.

Tres de las galaxias son elípticas y la cuarta parece ser una espiral cerrada, estrechando sus brazos alrededor de los dos miembros más cercanos. Dos pequeñas galaxias se pueden ver fuera del grupo.

Espectros tomados con los telescopios de 3,6 m de ESO y de 4 m del CTIO muestran que todas las galaxias tienen velocidades similares y que el grupo se encuentra a una distancia de aproximadamente 880 millones de años luz de nosotros. El diámetro del grupo es de aproximadamente 750.000 años luz. Ciertamente se continuará con el estudio de este cúmulo que tiene una impresionante apariencia y es increíblemente compacto.